

SERVICE MANUAL

01R/W

CONTENTS

1. SPECIFICATIONS	1
2. STRUCTURAL DIAGRAM	2
3. BLOCK DIAGRAM	3
4. CIRCUIT DIAGRAM	4-a
5. P.C. BOARDS	6
6. DIAGNOSTIC TEST	9
7. REFERENCE DATA	17
8. PARTS LIST	40

KORG

1. SPECIFICATIONS

Tone generation method	: AI square synthesis system (full digital processing)
Tone generator	: 32 voices, 32 oscillators (single mode); 16 voices, 32 oscillators (double mode)
Waveform memory	: PCM 48 Mbits
Effects	: two digital multi_effect systems
Programs	: 200 Programs
Combinations	: 200 Combinations
Sequencer section	: 10 Songs, 100 Patterns, maximum 7000 notes, 16 tracks, 16 timbers, (dynamic voice allocation)
Control inputs	: Assignable pedals 1, 2
Outputs	: 1/L, 2/R, 3, 4, headphones
PCM card slot	: PCM data
PROG/SEQ card slot	: for Program/Combination/Drum Kit/Global parameters /Sequence data
MIDI	: IN, OUT, THRU
Display	: LCD 64 x 240 dots, full dot matrix, with backlight
Options	: RAM card (SRC-512), ROM card, PCM card
Power consumption	: 11W
Dimensions	: 430(W) x 405.3(D) x 89(H)
Weight	: 4.9 kg

* Appearance and specifications are subject to change without notice for product improvement.

2. STRUCTURAL DIAGRAM

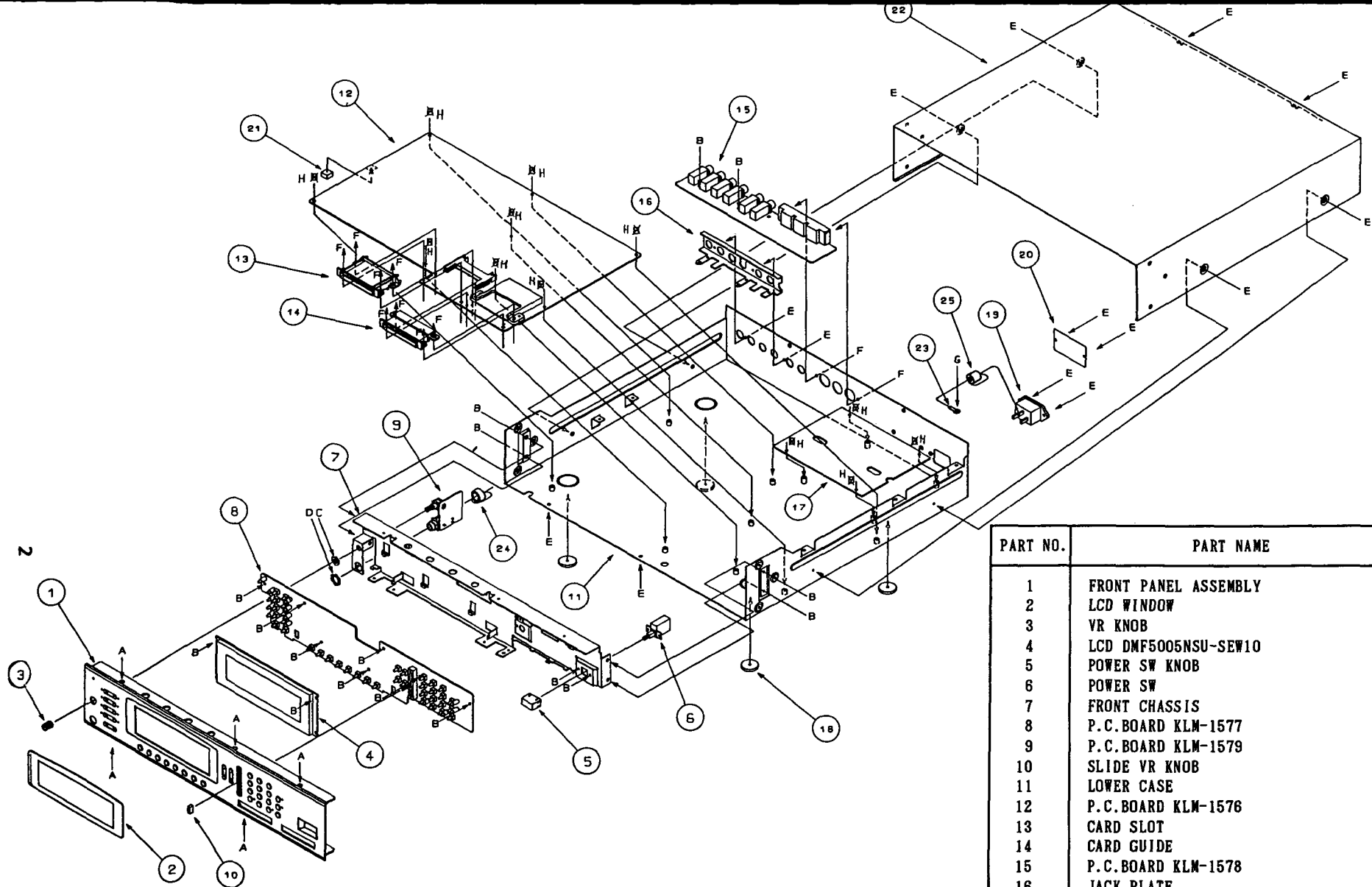

PART NO.	SCREWS & NUTS	PART CODE
A	TS F ZMC 3 x 6	791030306
B	CT B ZMC 3 x 6	715230306
C	VN BZMC 7	773060700
D	VN BZMC 12	773061200
E	CT B BZMC 3 x 8	715260308
F	PLAX B BZMC 3 x 10	745060310
G	TS SSE ZMC 4 x 10	715130411
H	FE B USE ZMC 3 x 6	790030306

PART NO.	PART NAME	PART CODE
1	FRONT PANEL ASSEMBLY	641027200
2	LCD WINDOW	630017200
3	VR KNOB	620023600
4	LCD DMF5005NSU-SEW10	313002400
5	POWER SW KNOB	620023100
6	POWER SW	375006100
7	FRONT CHASSIS	641027300
8	P.C. BOARD KLM-1577	001157700
9	P.C. BOARD KLM-1579	001157700
10	SLIDE VR KNOB	620022500
11	LOWER CASE	641027400
12	P.C. BOARD KLM-1576	001157600
13	CARD SLOT	646039500
14	CARD GUIDE	646039400
15	P.C. BOARD KLM-1578	001157700
16	JACK PLATE	641021900
17	P.C. BOARD KLM-1580 (FOR 100/117V)	002158000
	P.C. BOARD KLM-1581 (FOR 220/240V)	002158100
18	RUBBER FOOT 3 x 22 x 3	500018300
19	INLET SOCKET	-----
20	NAME PLATE	-----
21	RUBBER SPACER	500012900
22	UPPER CASE	640094800
23	LUG	-----
24	DATA LINE FILTER	525000800
25	EMI FERRITE	525000400

3. BLOCK DIAGRAM

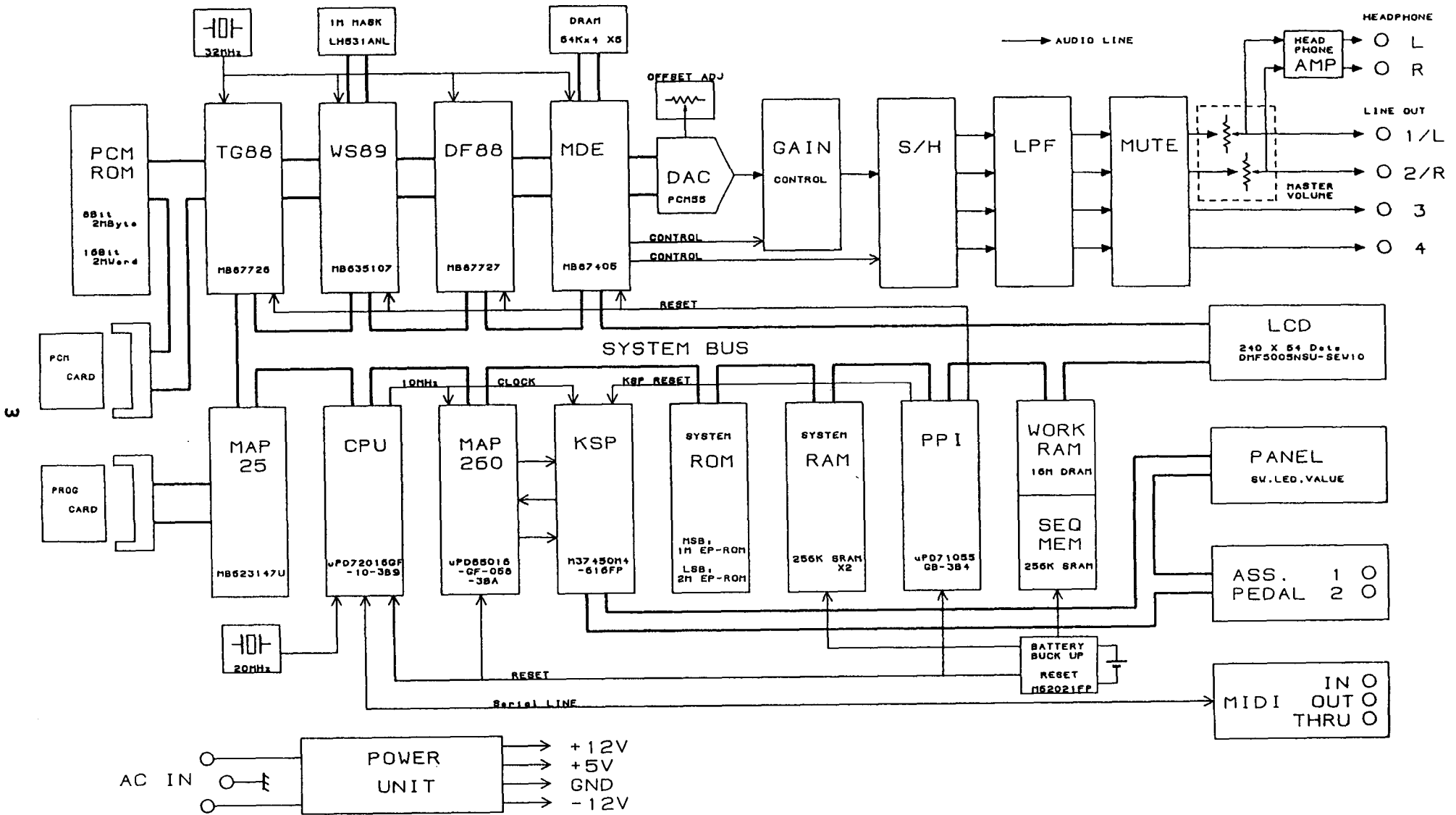

KLM-1580

4. CIRCUIT DIAGRAM

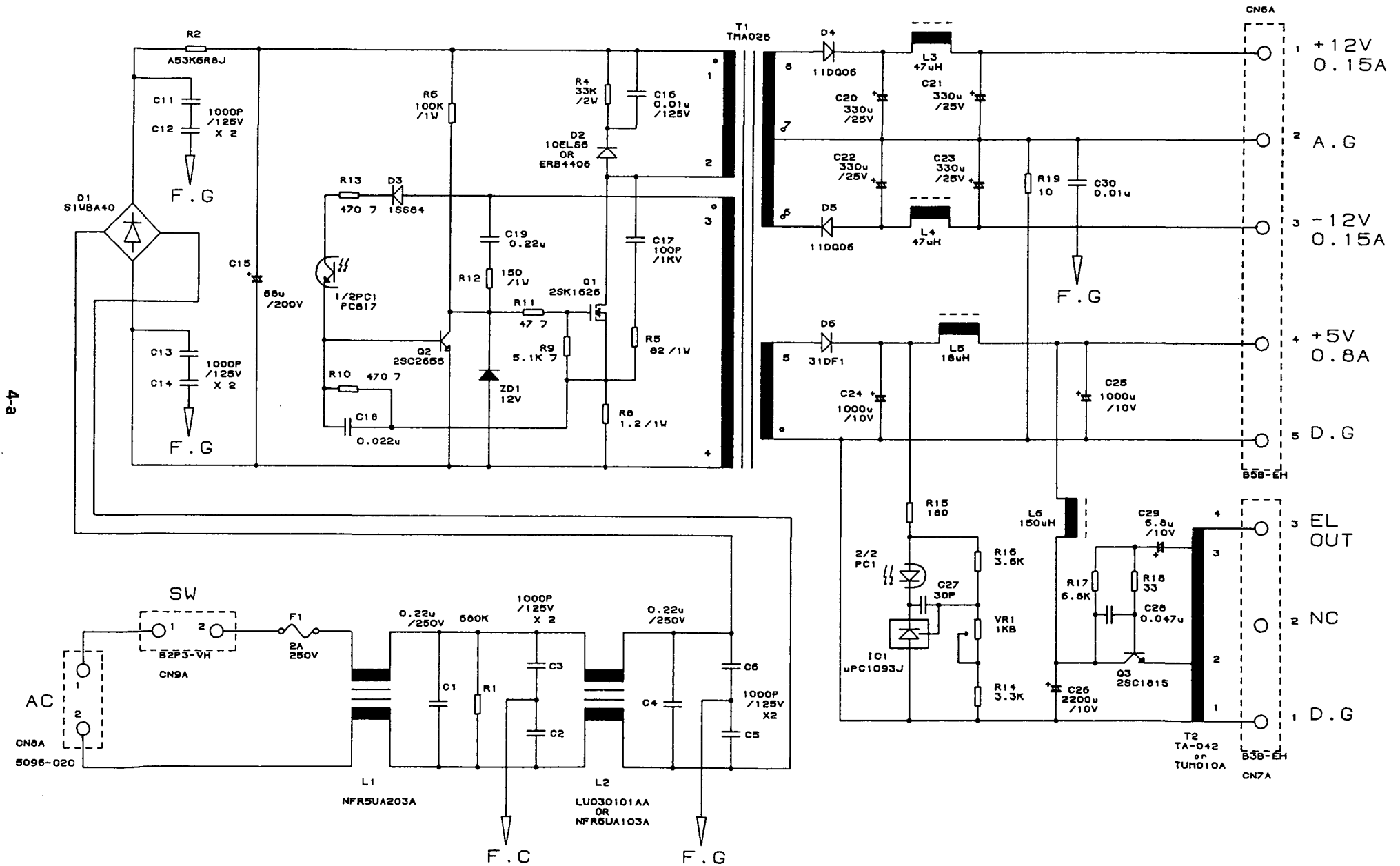

KLM-1576 MAIN BOARD

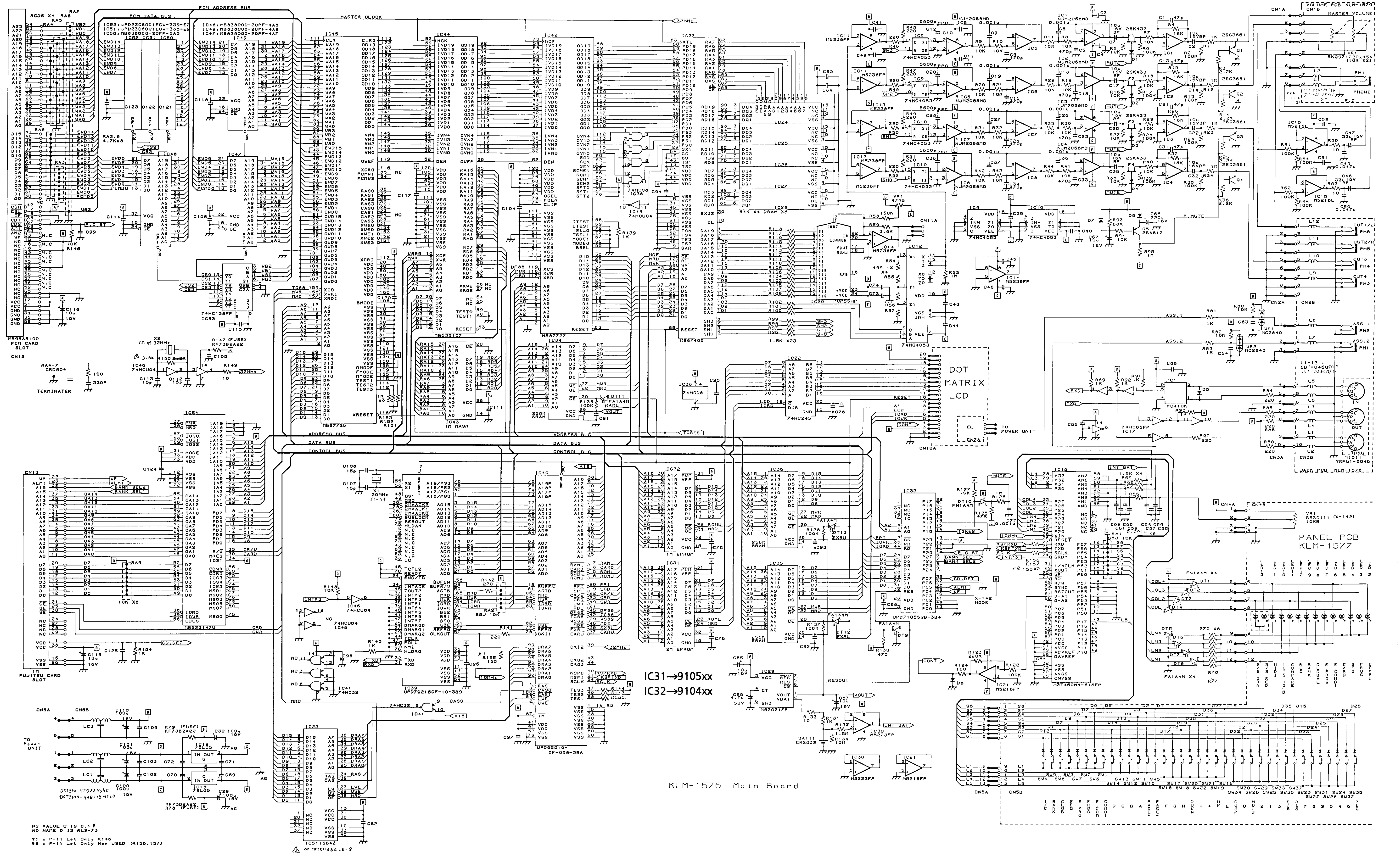

KLM-1581

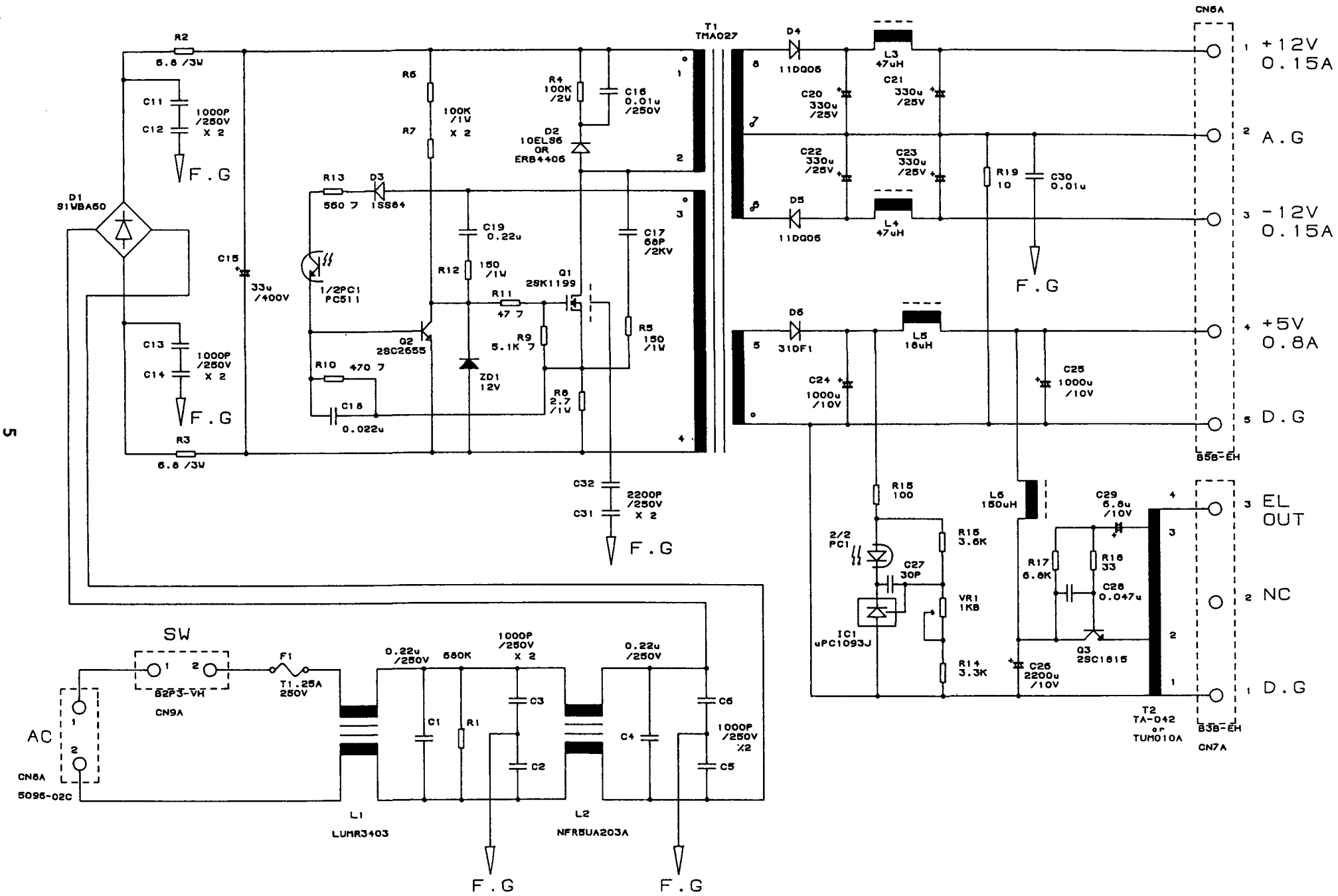

5. P.C. BOARDS

KLM-1576A

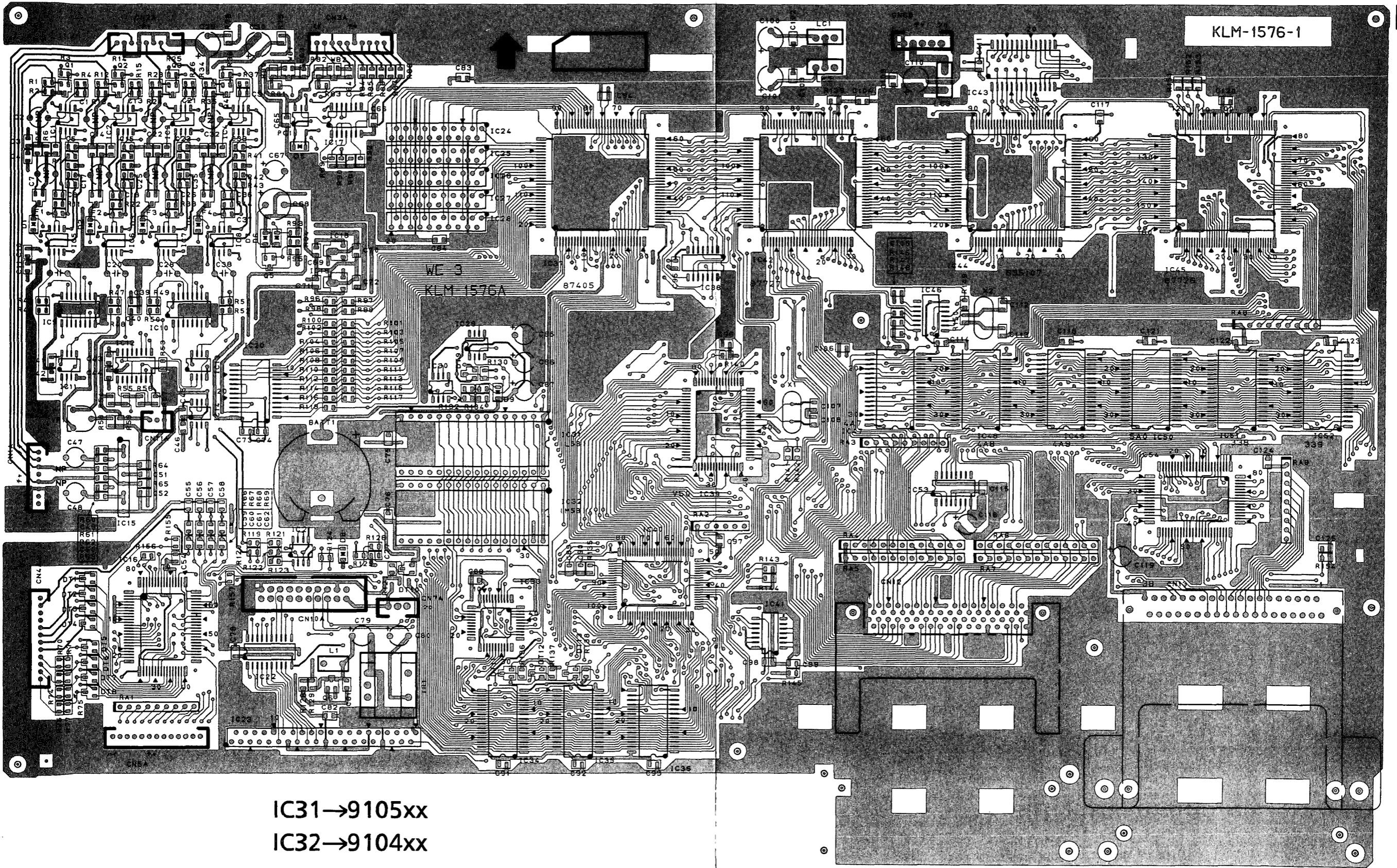

IC31→9105xx
IC32→9104xx

MOUNT PARTS SIDE

ぶひん面シルク



P.G.

P.G.



P.G.

Y03-1777



NO MOUNT PARTS SIDE

IC31 → 9105XX
IC32 → 9104XX

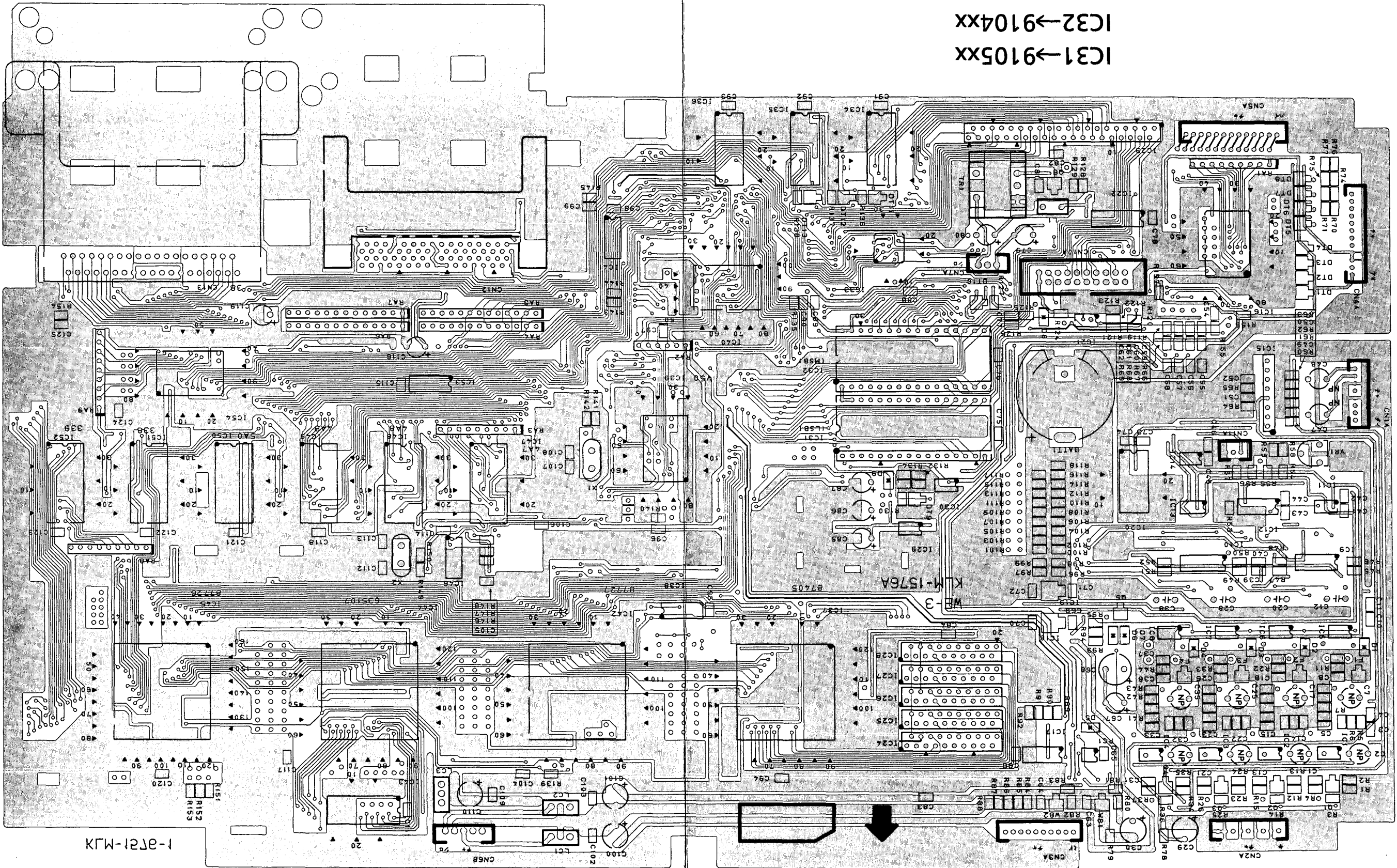

REV 2.0

70814807

1-8751-MJK

KLM-1576A

KLM-1578B/77B/79

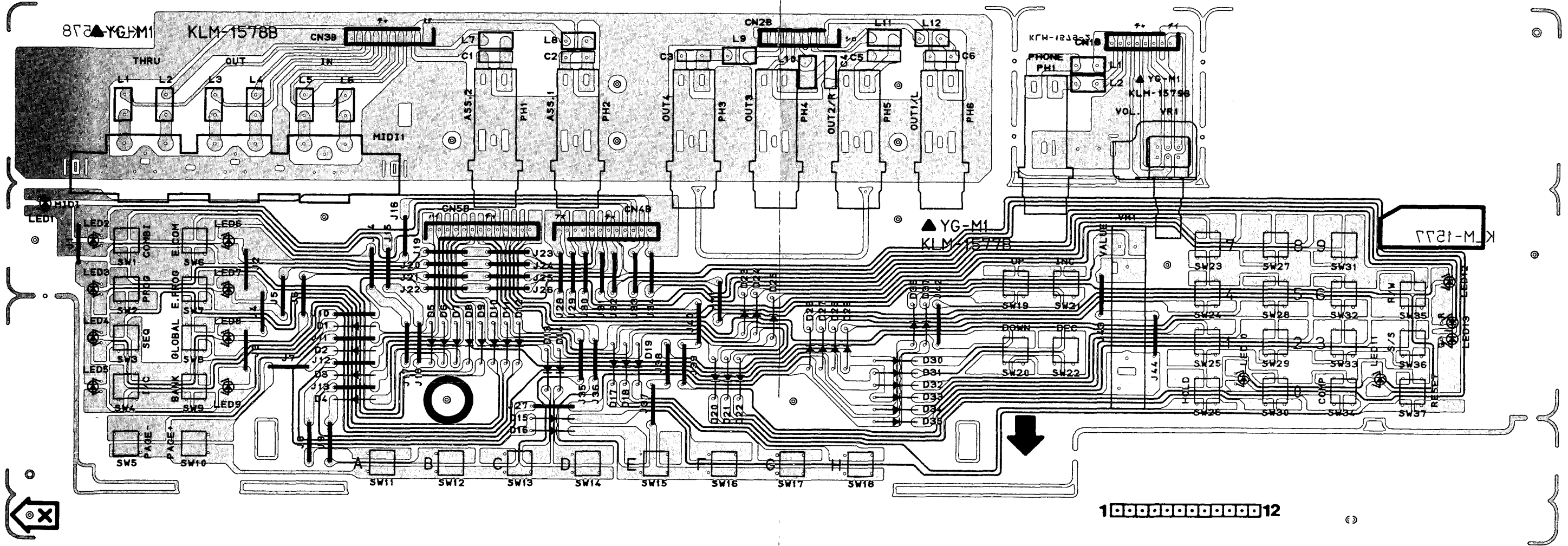

部品名

6. DIAGNOSTIC TEST

《Before you start the diagnostic test》

Once this diagnostic test is started, the data in the O1R/W is initialized. If necessary data are memorized in it, please save the data into RAM cards before starting the test.

《Starting the test program》

1. Connect MIDI IN and OUT with a MIDI cable.
2. Insert a PCM card (XSC-801) and a diagnostic test card into each card slot and turn the power ON.
At this time the protect switch of the test card must be OFF.
3. When the test program starts, the following tests are automatically carried out.

- * System ROM Check Sum (Internal Test #00)
- * Internal RAM Test (Internal Test #01)
- * RAM Card Test (Internal Test #02)
- * LCD RAM Test (Internal Test #03)
- * TG & DF CPU I/F Test (Internal Test #04)
- * Internal Battery Test (Internal Test #05)
- * Card Battery Test (Internal Test #06)
- * MIDI Loop Test (Internal Test #07)
- * PCM ROM TG I/F Test (Internal Test #08)
- * PCM Card TG I/F Test (Internal Test #09)

If any error occurs to the result of the internal test, the error message will be indicated in the LCD and the panel LEDs will go on and off.

When the internal test finishes normally, the program proceeds to TEST 1 : SW & LED TEST.

Then, when you turn the power ON while pressing '3' and 'RESET' to start the test mode, you can omit the PCM card test and the MIDI loop test.

In case that the protect switch of the RAM card is ON at the internal test #02 : RAM CARD TEST, the following message is indicated in the LCD.

* Error : Protect

In case that an error occurs at the internal test #04 : TG & DF I/F TEST, the following message is indicated in the LCD.

1) In case that an error occurs between the TG and the LCD,

- * Voice flag
- * TG too long busy
- * Voice on flag

2) In case that an error occurs between the DF and the CPU,

- * VDA
- * EXC
- * VDF
- * PAN

In case that MIDI IN and OUT are not connected with a MIDI cable at the internal test #07 : MIDI LOOP TEST, the following message is indicated in the LCD.

- * Error : OUT -X-→ IN (no connect)

《TEST 1 : PANEL SW & LED TEST》

The test of the panel switches and the confirmation of the LED's lighting are carried out.

1. Confirm that all the LEDs light red.
2. Press each switch according to the turn which is indicated in the LCD and confirm that they work correctly.
The turn to press the switches is as follows.

COMBI, PROG, SEQ, INT/CARD, PAGE-, EDIT COMBI, EDIT PROG,
GLOBAL, BANK, PAGE+, A, B, C, D, E, F, G, H, UP, DOWN,
▲, ▼, 7, 4, 1, 10'sHOLD/-, 8, 5, 2, 0, 9, 6, 3,
COMPARE, REC/WRITE, START/STOP, RESET

As for the switches whose LEDs light, confirm that the LEDs light red when the switches are pressed and then the LEDs light green when the switches are released.

3. When this check is finished to the RESET switch, the test program proceeds to the next automatically.

《TEST 2 : LCD PIXEL TEST》

The test of the LCD's indication is carried out.

1. Confirm that all the dots in the LCD light.
If nothing is wrong with the LCD, press RESET to proceed to the next.

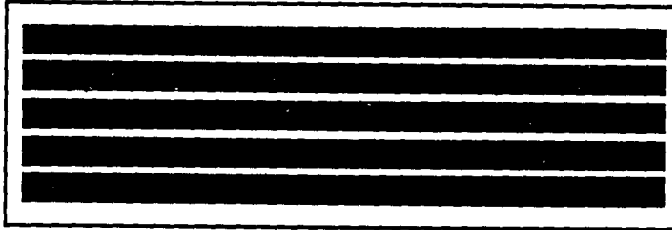

2. Confirm that all the dots in the LCD go out.
If nothing is wrong with the LCD, press RESET to proceed to the next.

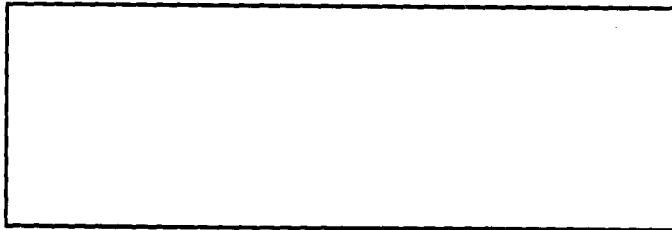

《TEST 3 : MDE/DF TEST》

MDE and DF88 are checked.
Connect an oscilloscope to OUTPUT 1.

1. Confirm that the output waveform of the MDE test is as follows.

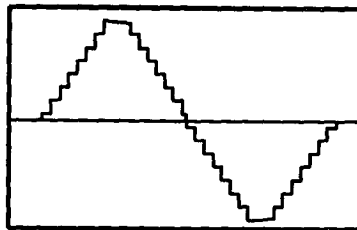

MDE TEST WAVEFORM

If this test is N.G., check the circuit connected with MDE (IC37) and the analog circuit.

If this test is O.K., press RESET to proceed to the next.

2. Confirm that an explosion sound is output normally at the DF test.
If this test is N.G., check the circuit between DF88 (IC42) and MDE (IC37).
If this test is O.K., press RESET to proceed to the next.

《TEST 4 : WS TEST》

WS is checked with its test waveform.

Confirm the following waveform appears when A, B, C or D is pressed.

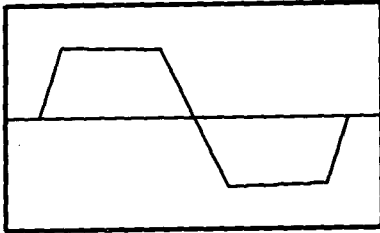

WS TEST WAVEFORM [A]

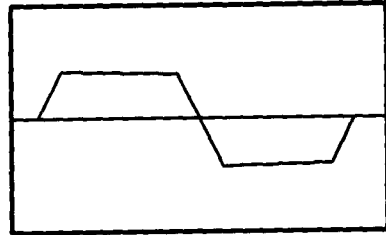

WS TEST WAVEFORM [B]

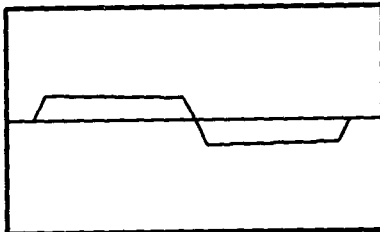

WS TEST WAVEFORM [C]

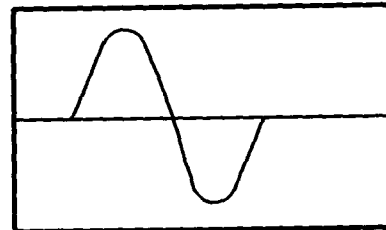

WS TEST WAVEFORM [D]

Check to the test waveform D and if this test is N.G., check the circuit connected with TG (IC45) and WS (IC44).

If this test is O.K., press RESET to proceed to the next.

《TEST 5 : TG TEST》

TG is checked with its test waveform.

Confirm the following waveform appears when one of A~H is pressed.

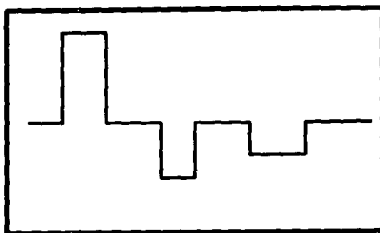

TG TEST WAVEFORM [A]

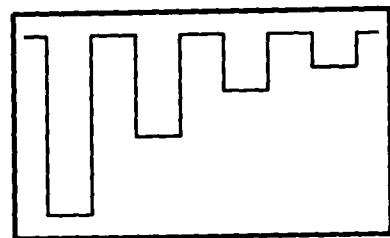

TG TEST WAVEFORM [B]~[D]

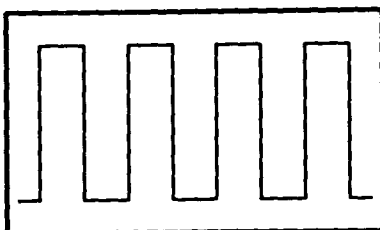

TG TEST WAVEFORM [E]~[H]

The waveforms of B~D are different at their output levels.
 The waveforms of E~H are different at their terms of cycle.
 Check to the test waveform H and if this test is N.G., check the
 circuit connected with TG (IC45).

If this test is O.K., press RESET to proceed to the next.

《TEST 6 : NOISE & OUTPUT TEST》

The remaining noise and the output signal level from each output jack
 are checked.

Set the master VR to the MAX and connect an oscilloscope or a noise meter
 to the OUTPUT jack which is to be checked.

1. Press any of A~F switches and measure the noise level of each OUTPUT
 jack with a noise meter.
 Confirm that the noise level of each OUTPUT jack is less than the
 regulation.
 After confirming the noise level of Ph-R of 'F', press RESET to
 proceed to the next check.

2. Press any of A~F switches and measure the output signal level of each
 OUTPUT jack with an oscilloscope.
 Confirm that the signal level of each OUTPUT jack is less than the
 regulation and each is the sine wave.
 Also, confirm that each output signal level changes at OUT-1 and OUT-2
 when the master VR is operated.
 After confirming the output signal level of Ph-R of 'F', press 'RESET'
 to proceed to the next.

	remaining noise	output signal level	frequency
OUT-1	-77.0dBu ↓	4.2 ~ 7.8 Vp-p	488 Hz
OUT-2	-77.0 dBu ↓	4.2 ~ 7.8 Vp-p	412 Hz
OUT-3	-76.0 dBu ↓	4.6 ~ 8.6 Vp-p	305 Hz
OUT-4	-76.0 dBu ↓	4.6 ~ 8.6 Vp-p	244 Hz
Ph-L	-78.0 dBu ↓	2.0 ~ 4.0 Vp-p	548 Hz
Ph-R	-78.0 dBu ↓	2.0 ~ 4.0 Vp-p	610 Hz

The regulations of the remaining noise and the output signal level

《TEST 7 : A/D TEST》

The A/D test of the VALUE slider, the ASS.pedals 1 & 2 are carried out.

1. Confirm that the value in the LCD changes between 0 (MIN) and 127 (MAX) when the VALUE slider is operated.
2. Confirm that the value in the LCD changes between 0 and 127 when an EXP-2 is connected to the ASS.pedal 1 or 2 and it is operated.

When all the checks are finished, press RESET to proceed to the menu screen.

《MENU SCREEN》

Selecting any number of 0 - 7 in the LCD with ten keys allows you to test the following.

0 : A/D Monitor	4 : WS
1 : Switch & LED	5 : TG
2 : LCD	6 : Noise & Level
3 : MDE / DF	7 : A/D Converter
A : PCM ROM CheckSum	D : PCM CardSum XSC-801

There are some other functions which correspond to the 'A', 'D', 'G', 'H' switches.

A : PCM ROM Check Sum
D : PCM CARD Check Sum (For XSC-801)
G : END → Refer to 《FINISHING THE TEST MODE》
H : CPY → Refer to 《COPY OF THE DIAGNOSTIC TEST CARD》

- ※ It takes a long time to complete A : PCM ROM Check Sum and D : PCM CARD Check Sum. Especially, it takes about 6 minutes to complete A : PCM ROM Check Sum.

1. PCM ROM Check Sum

This is used to find the defect of the PCM ROM data.
Even if the PCM ROM TG I/F test passes but the sound doesn't appear correctly, the defect of the ROM data will be considered.
In this case, you will find the defect of the data with this check.
But you will not know which ROM is defective from this check.

The operation is as follows.

When 'A' is pressed, 'Wait a minute' is indicated and the check starts.

It takes about 6 minutes to complete this check.

When it is finished normally, 'Completed' is indicated in the LCD.

2. PCM CARD Check Sum

This is used to find the defect of the PCM card (XSC-801) data.

The operation is as follows.

Confirm that a PCM card is inserted into the PCM card slot.

When 'D' is pressed, 'Wait a minute' is indicated in the LCD and the check starts.

It takes about 2 minutes to complete this check.

When it is finished normally, 'Completed' is indicated in the LCD.

《FINISHING THE TEST MODE》

1. When the diagnostic test card and the PCM card are removed from each slot and 'END' is pressed, the preload data is loaded automatically and the program proceeds to the normal mode.
2. After finishing the test mode, check the sound.

《COPY OF THE DIAGNOSTIC TEST CARD》

The O1R/W has the copy function of the RAM card for the diagnostic test and the data can be copied into the the other RAM card.

Note that the internal data is initialized by using this function as well as the diagnostic test because this test is in the test mode.

The operation is as follows.

1. Insert the diagnostic test card into the PROG/SEQ DATA slot and set the protect switch of the RAM card to be OFF.
2. Turn the power ON while pressing '3' and 'RESET' to start the test mode.
3. When the test mode is started, press 'REC/WRITE' to proceed to the menu screen.
4. Remove the diagnostic test card from the slot and insert a new RAM card.
Set the protect switch of the card to be OFF.
5. When 'CPY' is pressed, 'Save Start' is indicated in the LCD and the test data is saved into the new RAM card.
When saving is completed, 'Completed' is indicated in the LCD.
6. Remove the RAM card and then press 'END' to finish the test mode.

《INITIALIZING THE INTERNAL DATA》

When you turn the power ON while pressing 'RESET' and any of 'COMPARE', '3', '6' or '9' together, the version number of the system ROM is indicated in the LCD and the internal data is initialized. Then, if you would like to know the version number of the system ROM only, turn the power ON while pressing only 'RESET' - you will see the version number in the LCD without initializing the internal data.

《THE D/A OFFSET ADJUSTMENT ON THE KLM-1576 P.C. BOARD》

The D/A offset has been adjusted when the product is released on the market but you need to adjust it only in case that the D/A converter and its connected electronic parts.

Connect a digital volt meter to 1pin and 3pin of the connector CN11A on the KLM-1576 p.c.board. Then, confirm the offset voltage is 0V. If it is slipped off, adjust it with the VR1. When you adjust it with the oscilloscope, the voltage range should be less than 5mV.

7. REFERENCE DATA

M37450M4-601FP (KSP) PIN ASSIGNMENT

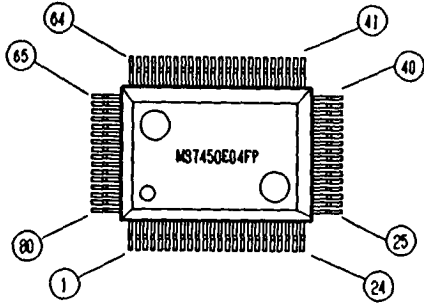

M37450M4-601FP PIN FUNCTION

PIN MARK	PIN NAME	I/O	PIN MARK	PIN NAME	I/O
VCC, VSS	POWER SUPPLY	-	P50~P57	I/O PORT 5	I/O
CNVSS	CNVSS	I	P60~P67	I/O PORT 6	I/O
RESET	RESET IN	I	VREF	REFERENCE VOLT.	I
XIN	CLOCK IN	I	ADVREF	A-D REF. VOLTAGE	I
XOUT	CLOCK OUT	O	DAVREF	D-A REF. VOLTAGE	I
φ	TIMMING OUT	O	AVSS	ANALOG VSS	-
SYNC	SYNC. SIGNAL OUT	O	AVCC	ANALOG VCC	-
R/W	READ/WRITE STATUS OUT	O	D-A1 D-A2	ANALOG OUT	O O
P00~P07	I/O PORT 0	I/O	RD	READ SIG. OUT	O
P10~P17	I/O PORT 1	I/O	WR	WRITE SIG. OUT	O
P20~P27	I/O PORT 2	I/O	RESETOUT	RESET SIG. OUT	O
P30~P37	I/O PORT 3	I/O	RXD	SERIAL DATA IN	I
P40~P42	I/O PORT 4	I	TXD	SERIAL DATA OUT	O

CHECK POINT FOR M37450M4-601FP

1. XIN (28pin)

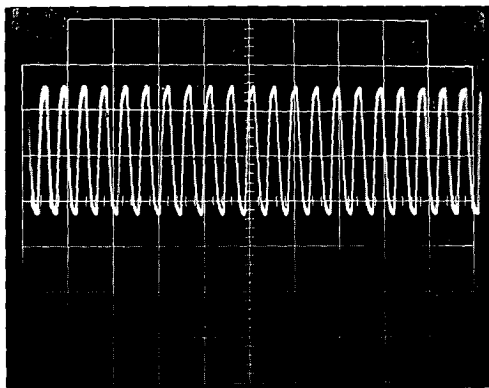

T=0.1mS

2V/0.2uS div

2. RXD (77pin)

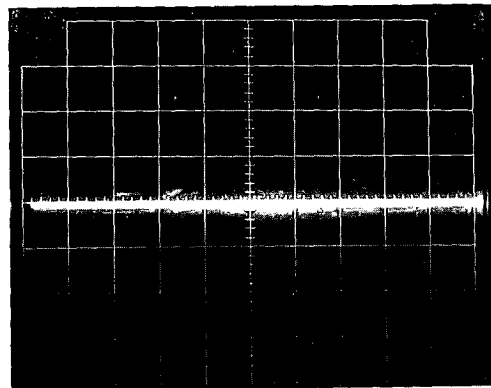

2V/5mS div

MB87726 (TG88)
PIN ASSIGNMENT

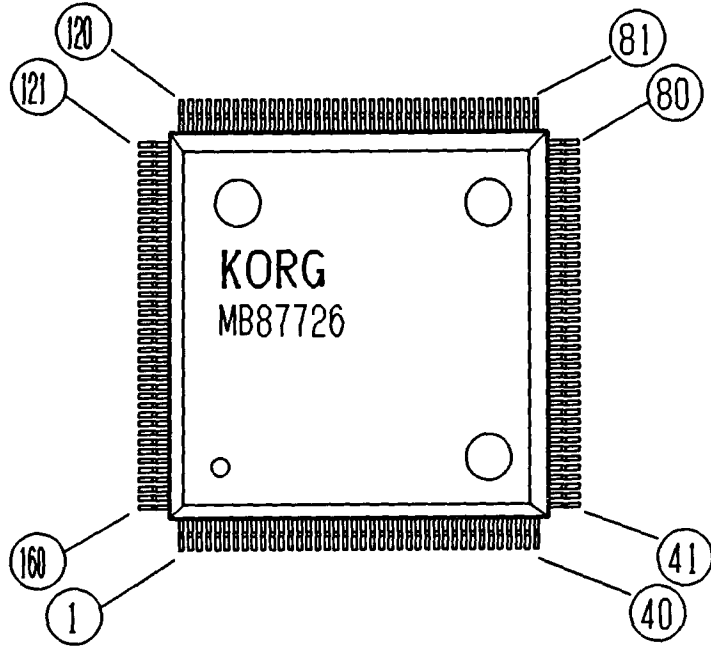

MB87726 (TG88)
PIN FUNCTION

PIN NAME	I/O	FUNCTION
VDD	-	+5V
VSS	-	GND
SMODE	I	Sub TG Mode (H:Sub TG L:Master TG)
FMODE	I	Sampling Rate Switch (H:48KHz L:30KHz)
XRESET	I	Low Active Initial Clear
CLK	I	Master Clock
XCRO	O	System Counter Reset for Sub TG Chip
XCRI	I	System Counter Reset from Master TG Chip
TEST0-3	I	Test Mode Selector
XCSI	I	Chip Select
XWRI	I	Write Pulse Input from CPU
XRDI	I	Read Pulse Input from CPU
A0-9	I	Address Input from CPU
D0-7	I/O	Data Input from CPU
D8-15	I/O	Data Input for 16bit Data Bus
DMODE	I	CPU I/F Data Bus Syze Select (L:8bit H:16bit)
EWDO-15	I	Even-address Wave Data In (from Wave ROM)
OWDO-15	I	Odd-address Wave Data In (from Wave ROM)
WAO-19	O	Address Bus for Wave ROM or RAM
WBO-3	O	Bank Number Out for Wave ROM (16 Banks)
ODO-19	O	Voice Data Out for External Filters or MDE
VNO-4	O	Voice Number Out
RASO-3	O	for D-RAM
CASO-3	O	for D-RAM
OWEO-3	O	Write Enable for MDE
OWEF	O	Write Enable for New Filter Chip (MB87727)

CHECK POINT FOR MB87726

1. OWEF (119pin)

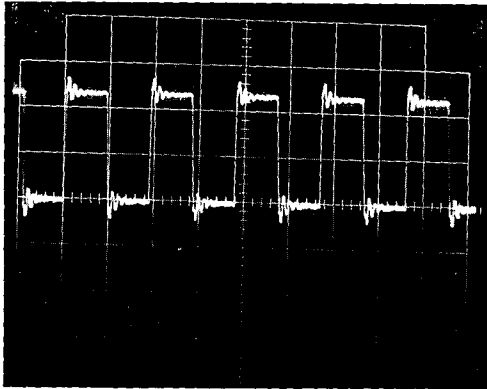

duty cycle of 50% $T=0.1\mu\text{S}$
2V/0.5uS div

2. CLK (111pin)

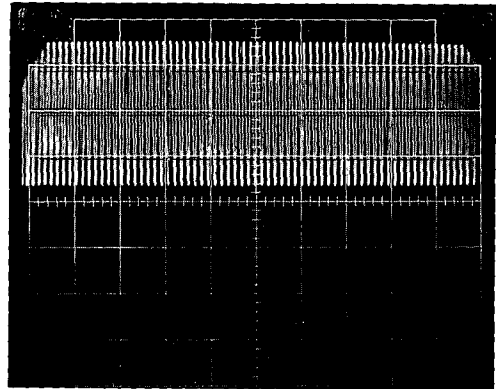

1V/0.2uS div

3. OD0~OD18 (144~123pin)

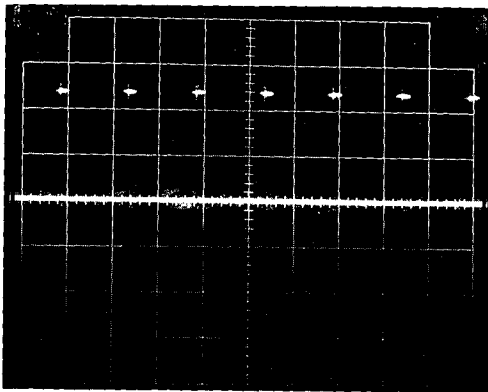

2V/20uS div

4. OD19 (122pin)

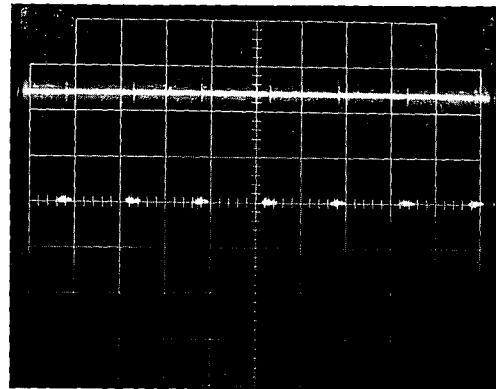

2V/20uS div

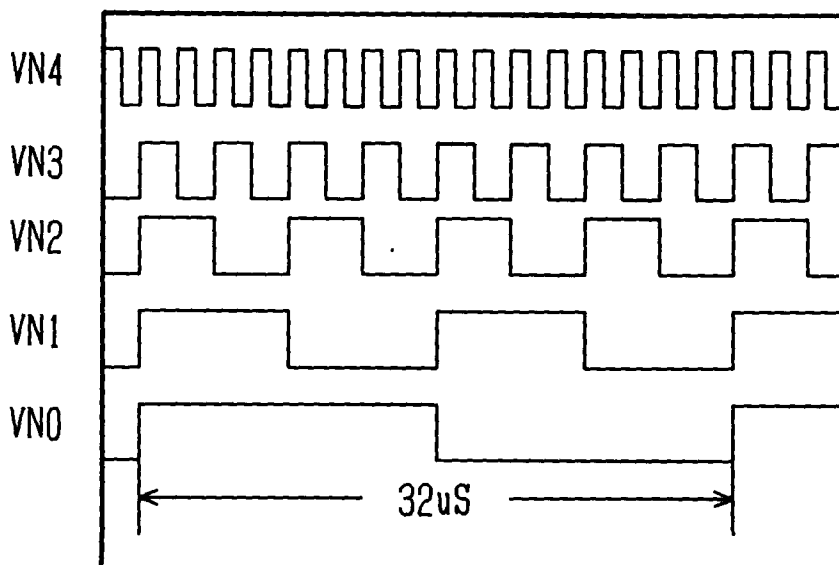

MB87727 (DF88)
PIN ASSIGNMENT

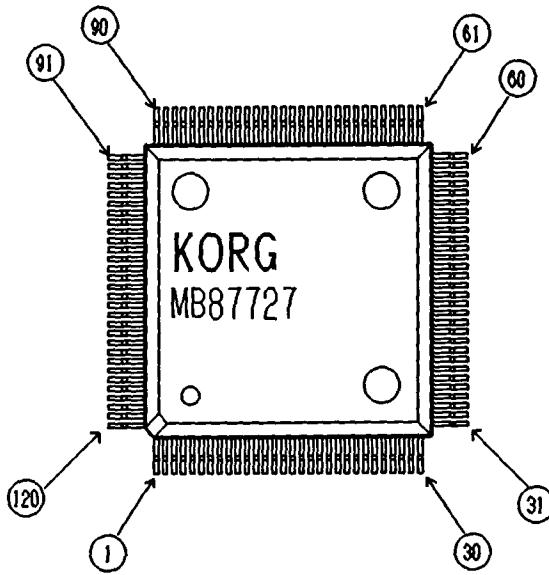

MB87727 (DF88)
PIN FUNCTION

NO.	I/O	PIN NAME	GROUP	NOTE
1	-	VSS	-	
2	I	A0	A	CPU ADDRESS
3	I	A1		
4	I	A2		
5	I	A3		
6	I	A4		
7	I	A5		
8	I	A6		
9	I	A7		
10	I	A8		
11	-	VSS	-	
12	I	A9	B	CPU ADDRESS
13	I/O	D0		CPU DATA BUS
14	I/O	D1		
15	I/O	D2		
16	-	VDD	-	
17	I/O	D3	B	CPU DATA BUS
18	I/O	D4		
19	I/O	D5		
20	I/O	D6		
21	-	VSS	-	
22	I/O	D7	C	CPU DATA BUS
23	I/O	D8		
24	I/O	D9		
25	I/O	D10		
26	I/O	D11		
27	I/O	D12		
28	I/O	D13		
29	I/O	D14		
30	I/O	D15		

NO.	I/O	PIN NAME	GROUP	NOTE
31	-	VSS	-	
32	I	IVNO	D	TG VOICE NO.
33	I	IVN1		
34	I	IVN2		
35	I	IVN3		
36	I	IVN4		
37	I	IVD0		
38	I	IVD1		
39	I	IVD2		
40	I	IVD3		
41	-	VSS	-	
42	I	IVD4	E	TG VOICE DATA
43	I	IVD5		
44	I	IVD6		
45	I	IVD7		
46	-	VDD	-	
47	I	IVD8	E	TG VOICE DATA
48	I	IVD9		
49	I	IVD10		
50	I	IVD11		
51	-	VSS	-	
52	I	IVD12	F	TG VOICE DATA
53	I	IVD13		
54	I	IVD14		
55	I	IVD15		
56	I	IVD16		
57	I	IVD17		
58	I	IVD18		
59	I	IVD19		
60	-	VDD	-	
61	-	VSS	-	
62	I	DEN	G	TG VOICE DATA ENABLE
63	I	XRES		SYSTEM RESET
64	I	OSEL		PARALLEL OUT FORMAT SELECT
65	I	BSEL		CPU DBUS BIT LENGTH SELECT
66	I	MODE0		FILTER MODE SELECT
67	I	MODE1		INCIRCUIT TESTER MODE SELECT
68	I	ITEST		LSI TESTER MODE SELECT
69	I	LTEST		MASTER CLOCK
70	I	MCK		
71	-	VSS	-	
72	I	TSELO	H	NOT USE
73	I	TSEL1		
74	I	CLIP		OUTPUT DATA CLIPER ON/OFF
75	I	SFT0		DATA SHIFT SELECT BIT0
76	-	VDD	-	
77	I	SFT1	H	DATA SHIFT SELECT BIT1
78	I	SFT2		DATA SHIFT SELECT BIT2
79	O	POEN		PARALLEL OUT VOICE DATA ENABLE
80	O	SOD		SERIAL OUT DATA

NO.	I/O	PIN NAME	GROUP	NOTE
81	-	VSS	-	
82	0	SCK	I	SERIAL OUT BIT CLOCK
83	0	SEN		SERIAL OUT DATA ENABLE
84	0	SCH2		SERIAL OUT CH NO. BIT2
85	0	SCH1		SERIAL OUT CH NO. BIT1
86	0	SCHO		SERIAL OUT CH NO. BIT0
87	0	SCHEN		SERIAL OUT CH DATA ENABLE
88	0	OD19		VOICE/MIX
89	0	OD18		PARALLEL
90	0	OD17		OUTPUT
91	-	VSS		-
92	0	OD16	J	OUTPUT
93	0	OD15		
94	0	OD14		
95	0	OD13		
96	0	OD12		
97	0	OD11		
98	0	OD10		
99	0	OD9		
100	0	OD8		
101	-	VSS	-	
102	0	OD7	K	OUTPUT
103	0	OD6		
104	0	OD5		
105	0	OD4		
106	-	VDD	-	
107	0	OD3	K	OUTPUT
108	0	OD2		
109	0	OD1		
110	0	OD0		
111	-	VSS	-	
112	0	OVN4	L	PARALLEL OUT
113	0	OVN3		VOICE NO.
114	0	OVN2		
115	0	OVN1		
116	0	OVNO		
117	I	XRD		CPU RD ENABLE
118	I	XWR		CPU WR ENABLE
119	I	XCS		CHIP SELECT
120	-	VDD	-	

CHECK POINT FOR MB87727

1.OVNO~OVN3 (116~113pin)

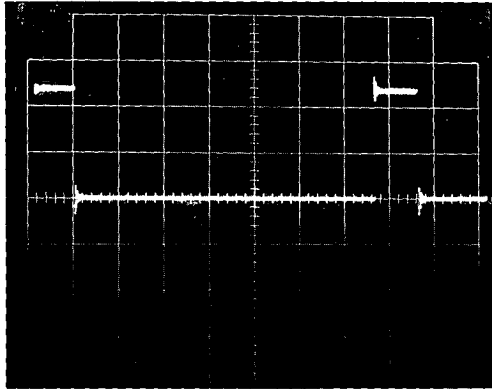

T=16uS

2V/2uS div

2.MCK (52pin)

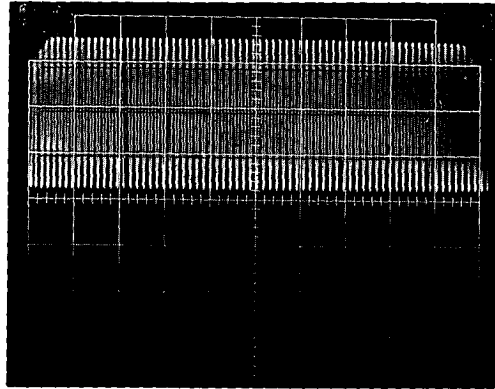

2V/0.2uS div

3.ODO~OD19 (110~88pin)

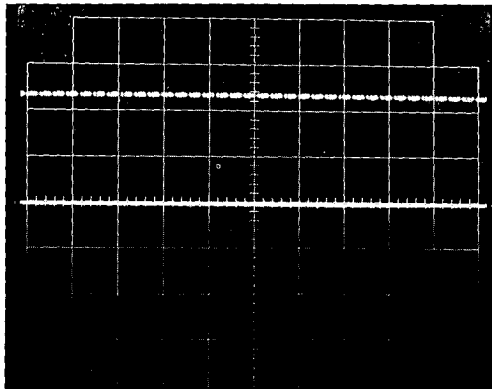

2V/0.1mS div

**CLASSIFICATION OF
TERMINALS FOR DF88**

CLASSIFICATION	TERMINALS
CPU INTERFACE	BSEL, XCS, XRD, XWR AO~A9, DO~D15
PARALLEL OUT (MDE1 INTERFACE)	OSEL, ODO~OD19 OVNO~OVN4, POEN
SERIAL OUT (MDE2 INTERFACE)	SOD, SCK, SEN SCHO~SCH2, SCHEN
MIXER	SFTO~SFT2, CLIP
PARALLEL IN (TG, DF INTERFACE)	IVDO~IVD19 IVNO~IVN4, DEN
MASTER CLOCK	MCK
RESET	XRES
FILTER MODE	MODE0~MODE1
TEST MODE	ITEST, LTEST TSELO, TSEL1
POWER SUPPLY	VDD1~VDD6 VSS1~VSS12

MB87405 (MDE)
PIN ASSIGNMENT

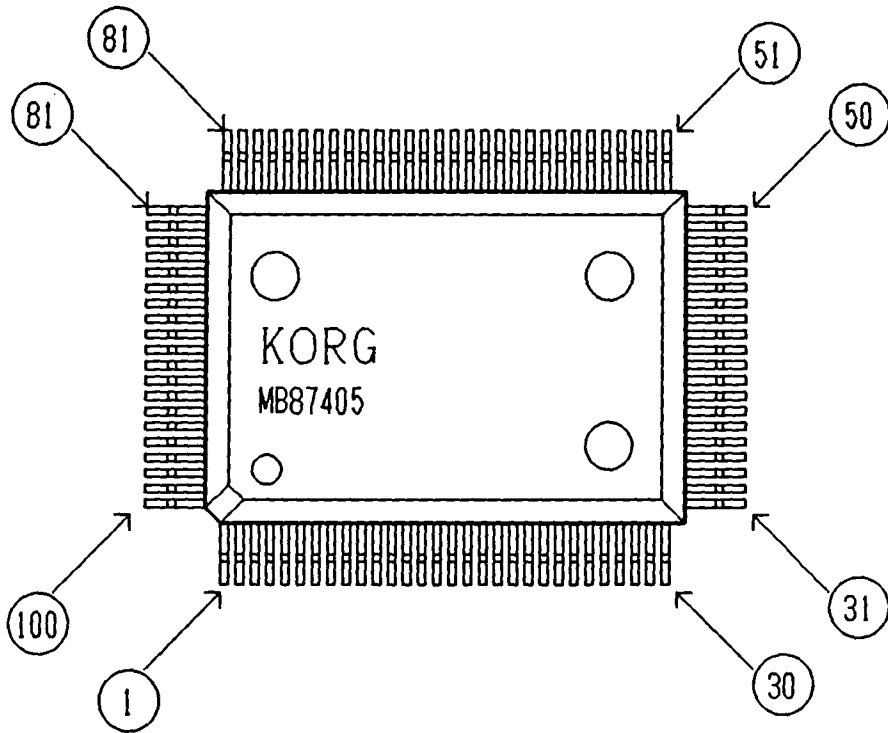

MB87405 (MDE)
PIN FUNCTION

PIN NAME	I/O	PIN NAME	I/O	PIN NAME	I/O
80	I	OE	O	SX1, SX32	O
CS	I	WE	O	PDO~PD19	I
RD	I	RA0~RA7	O	GC	I
WR	I	RDO~RD19	I/O	RESET	I
A0~A2	I	DAO~DA19	O	XTL	I
D0~D7	I/O	SH0~SH3	O	TS0~TS5	I
RAS	O	SAR	I	VDD0~VDD3	---
CAS	O	OL	O	VSS0~VSS7	---

CHECK POINT FOR MB87405

1. XTL (63pin)

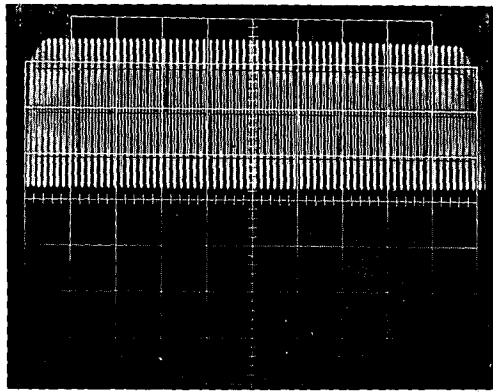

1V/0.2uS div

2. SX1 (29pin)

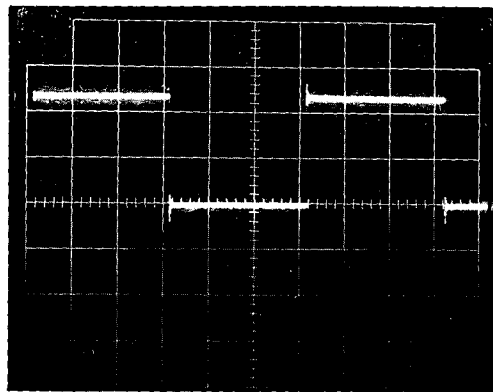

duty cycle of 50% T=32uS

2V/5uS div

3. DA4~DA18 (114~120, 2, 3pin)

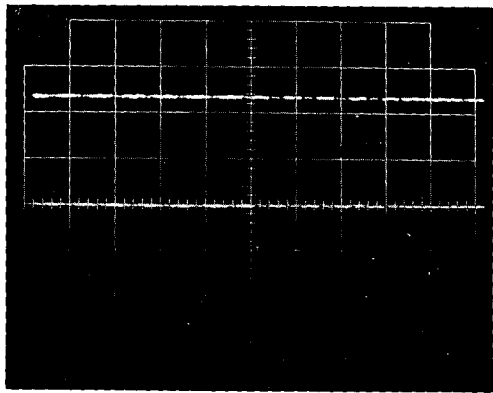

2V/2mS div

4. DA19 (4pin)

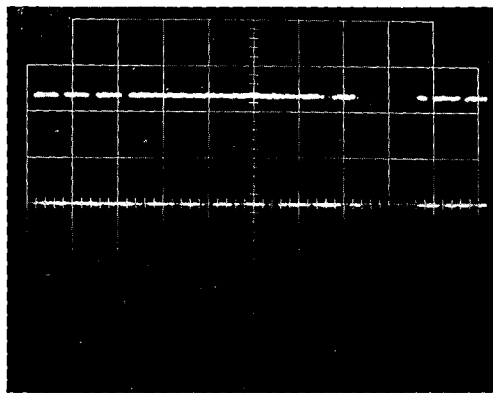

2V/10mS div

5. SH0~SH4 (5~8pin)

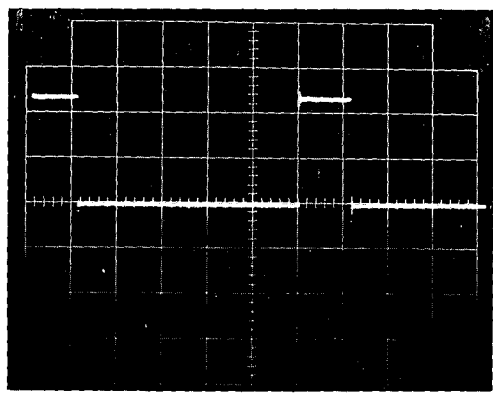

2V/5uS div

μ PD71055GB-10-3B4 (PPI)

PIN FUNCTION

PIN NAME	I/O	FUNCTION	PIN NAME	I/O	FUNCTION
D7~D0	I/O	Data Bus	RESET	I	Reset
CS	I	Chip Select	P07~P00	I/O	I/O Port0
RD	I	Read Strobe	P17~P10	I/O	I/O Port1
WR	I	Write Strobe	P27~P20	I/O	I/O Port2
A1, A0	I	Address	IC	---	Internally Connected

μ PD65016GF (MAP260)

PIN ASSIGNMENT

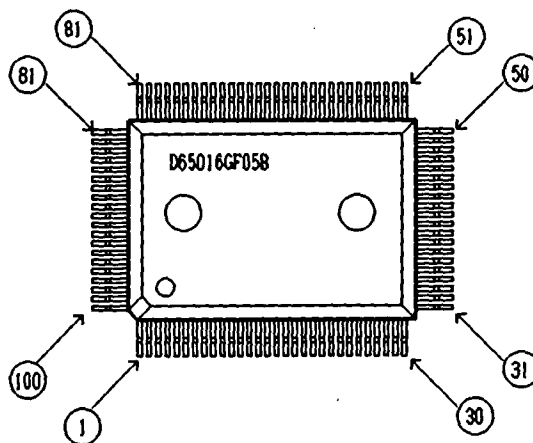

μ PD65016-XXX-3BA (MAP260)

PIN FUNCTION

PIN NO.	PIN NAME	I/O	FUNCTION
01	GND-----		
02	VDD-----		
03	CAS0	0	column address strobe to D_RAM
04	RAS	0	row address strobe to D_RAM
05	ROML	0	lower byte ROM chip select
06	ROMU	0	upper byte ROM chip select
07	RAML	0	lower byte S_RAM chip select
08	RAMU	0	upper byte S_RAM chip select
09	A17	0	address out
10	A16	0	address out
11	A13	0	address out
12	A15	0	address out
13	A14	0	address out
14	A08	0	address out
15	GND-----		
16	A07	0	address out
17	A09	0	address out
18	PWR	0	S_RAM write enable (protectable write)
19	SP1	0	I/O chip select out
20	PPI	0	PPI chip select low active
21	FDC	0	FDC chip select low active
22	SP2	0	I/O chip select out
23	SP3	0	I/O chip select out
24	A10	0	address out
25	A06	0	address out
26	A05	0	address out
27	A12	0	address out
28	GND-----		
29	VDD-----		
30	A04	0	address out
31	A03	0	address out
32	A11	0	address out
33	A02	0	address out
34	A01	0	address out
35	A00	0	address out
36	MSP1	0	memory chip select out
37	MSP2	0	memory chip select out
38	CK01	0	clock out
39	CK12	I	clock in
40	GND-----		
41	MCLK	I	master clock
42	TG88	0	TG88 chip select low active
43	CK02	0	clock out
44	CK03	0	clock out (1/2 CK12)
45	DF88	0	DF88 chip select low active
46	MDE	0	MDE chip select low active
47	TES3	I	TEST mode active high
48	SP1	0	chip select out
49	CK00	0	clock out

PIN NO.	PIN NAME	I/O	FUNCTION
50	KSP	O	serial data out to key scanner (RxD)
51	KSPI	I	serial data in from key_scanner (TxD)
52	VDD-----		
53	GND-----		
54	SCLK	O	serial clock out to key_scanner (SCLK)
55	XRES	I	reset_input low active
56	AD00	I	address data multiplex in from V50FDC
57	AD01	I	address data multiplex in from V50FDC
58	AD02	I	address data multiplex in from V50FDC
59	AD03	I	address data multiplex in from V50FDC
60	AD04	I	address data multiplex in from V50FDC
61	AD05	I	address data multiplex in from V50FDC
62	AD06	I	address data multiplex in from V50FDC
63	AD07	I	address data multiplex in from V50FDC
64	AD08	I	address data multiplex in from V50FDC
65	GND-----		
66	AD09	I	address data multiplex in from V50FDC
67	AD10	I	address data multiplex in from V50FDC
68	AD11	I	address data multiplex in from V50FDC
69	AD12	I	address data multiplex in from V50FDC
70	AD13	I	address data multiplex in from V50FDC
71	AD14	I	address data multiplex in from V50FDC
72	AD15	I	address data multiplex in from V50FDC
73	A16P	I	address in from V50FDC
74	A17P	I	address in from V50FDC
75	A18P	I	address in from V50FDC
76	A19P	I	address in from V50FDC
77	RFRQ	I	from V50FDC
78	CKI1	I	clock in
79	VDD-----		
80	GND-----		
81	ASTB	I	address strobe in from V50FDC
82	UBE	I	upper bank enable in
83	IOWR	I	I/O write enable in from V50FDC
84	MWR	I	memory write enable in from V50FDC
85	IORD	I	I/O read enable in from V50FDC
86	MRDI	I	memory read enable in from V50FDC
87	1M	I	1M D_RAM mode select (low → 1M D_RAM)
88	TES1	I	TEST MODE
89	LWE	O	D_RAM lower byte write enable
90	TES2	I	TEST MODE
91	UWE	O	D_RAM upper byte write enable
92	DRA0	O	D_RAM address out
93	DRA1	O	D_RAM address out
94	DRA2	O	D_RAM address out
95	DRA3	O	D_RAM address out
96	DRA4	O	D_RAM address out
97	DRA5	O	D_RAM address out
98	DRA6	O	D_RAM address out
99	DRA7	O	D_RAM address out
100	CAS1	O	column address strobe to D_RAM

MB635107 (WS89)
PIN ASSIGNMENT

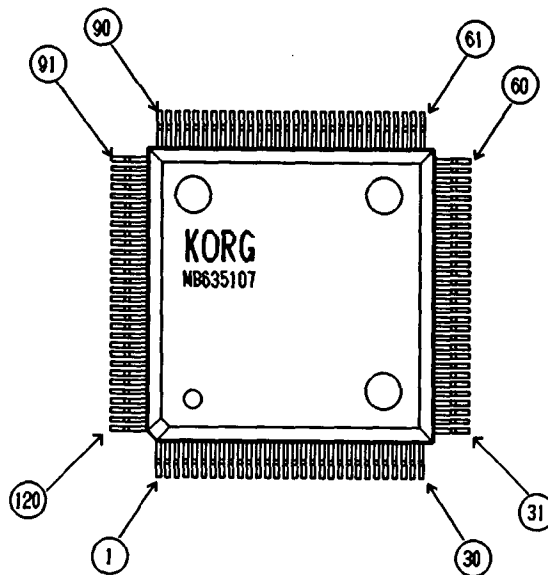

MB635107 (WS89)
PIN FUNCTION

PIN NAME	I/O	FUNCTION
A5~A0	I	CPU address in
D7~D0	I	CPU data in
XWR	I	CPU write enable
XCS	I	CPU chip select
IVD19~IDVO	I	sound data bus from TG88
IVN4~IVNO	I	voice number from TG88
DEN	I	data enable from TG88 (OWEF)
RA16~RA0	O	TABLE_ROM address
RD7~RDO	I	TABLE_ROM data
XRWE	O	S_RAM write enable for TABLE_RAM
XROE	O	S_RAM output enable for TABLE_RAM
OVD19~OVDO	O	sound data out to DF88
OVN4~OVNO	O	voice number out to DF88
OWEF	O	data enable to DF88
MCK	I	master clock
XRES	I	system reset
TEST1, 2	O	TEST MODE
VDD	---	+5V
VSS	---	GND

MB635107 (WS89) PIN I/O

NO.	I/O	PIN NAME	NO.	I/O	PIN NAME	NO.	I/O	PIN NAME	NO.	I/O	PIN NAME
1	---	VSS	26	I/O	RD4	51	---	VSS	76	---	VDD
2	I	A0	27	I/O	RD5	52	I	MCK	77	0	RA9
3	I	A1	28	I/O	RD6	53	I	IVD13	78	0	RA10
4	I	A2	29	I/O	RD7	54	I	IVD14	79	0	RA11
5	I	A3	30	I	IVN0	55	I	IVD15	80	0	RA12
6	I	A4	31	---	VSS	56	I	IVD16	81	---	VSS
7	I	A5	32	I	IVN1	57	I	IVD17	82	0	RA13
8	---	N.C.	33	I	IVN2	58	I	IVD18	83	0	RA14
9	I	XWR	34	I	IVN3	59	I	IVD19	84	0	RA15
10	I	XCS	35	I	IVN4	60	---	VDD	85	0	RA16
11	---	VSS	36	I	IVD0	61	---	VSS	86	0	XRWE
12	I	D0	37	I	IVD1	62	I	DEN	87	0	XROE
13	I	D1	38	I	IVD2	63	I	XRES	88	0	OWEF
14	I	D2	39	I	IVD3	64	---	N.C.	89	I	TEST0
15	I	D3	40	I	IVD4	65	---	N.C.	90	I	TEST1
16	---	VDD	41	---	VSS	66	0	RA0	91	---	VSS
17	I	D4	42	I	IVD5	67	0	RA1	92	0	OVD19
18	I	D5	43	I	IVD6	68	0	RA2	93	0	OVD18
19	I	D6	44	I	IVD7	69	0	RA3	94	0	OVD17
20	I	D7	45	I	IVD8	70	0	RA4	95	0	OVD16
21	---	VSS	46	---	VDD	71	---	VSS	96	0	OVD15
22	I/O	RDO	47	I	IVD9	72	0	RA5	97	0	OVD14
23	I/O	RD1	48	I	IVD10	73	0	RA6	98	0	OVD13
24	I/O	RD2	49	I	IVD11	74	0	RA7	99	0	OVD12
25	I/O	RD3	50	I	IVD12	75	0	RA8	100	0	OVD11

NO.	I/O	PIN NAME	NO.	I/O	PIN NAME	NO.	I/O	PIN NAME	NO.	I/O	PIN NAME
101	---	VSS	106	---	VDD	111	---	VSS	116	0	OVN3
102	0	OVD10	107	0	OVD6	112	0	OVD2	117	0	OVN2
103	0	OVD9	108	0	OVD5	113	0	OVD1	118	0	OVN1
104	0	OVD8	109	0	OVD4	114	0	OVD0	119	0	OVNO
105	0	OVD7	110	0	OVD3	115	0	OVN4	120	---	VDD

CHECK POINT FOR MB635107

1. OD18~OD0 (93~114pin)

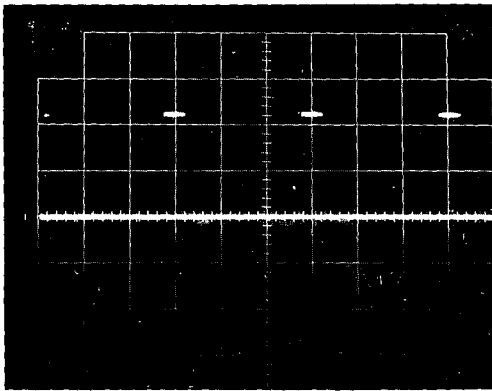

2V/5uS div

2. OD19 (92pin)

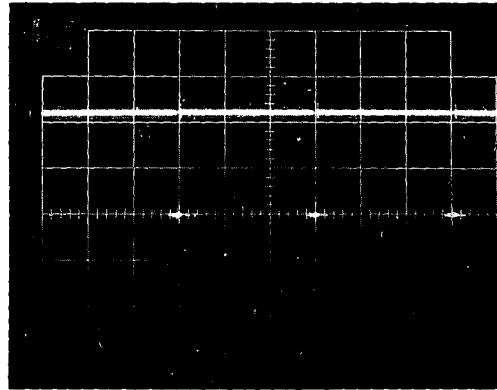

2V/5uS div

3. OWEF (88pin)

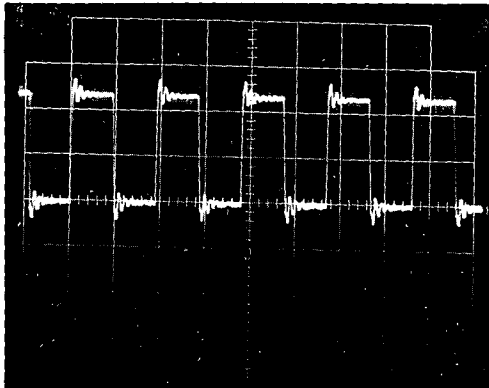

duty cycle of 50%

2V/0.5uS div

4. OVN4~0 (115~119pin)

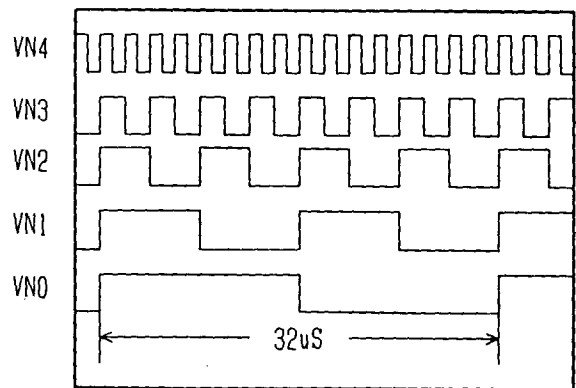

duty cycle of 50%

MB623147U (MAP25)
PIN ASSIGNMENT

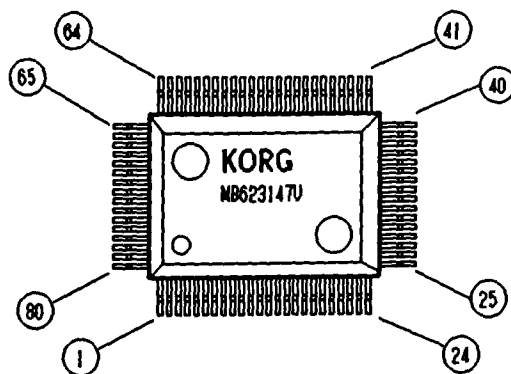

MB623147U (MAP25)
PIN FUNCTION

NO.	I/O	PIN NAME	NO.	I/O	PIN NAME	NO.	I/O	PIN NAME	NO.	I/O	PIN NAME
1	I	IA19	21	I	IA8	41	O	OA7	61	O	OA11
2	I	IA18	22	I	IA7	42	O	OA6	62	O	OA9
3	I	IA17	23	I	IA6	43	O	OA5	63	O	OA8
4	I	IA16	24	I	IA5	44	O	OA4	64	O	OA13
5	I	IA15	25	I	IA4	45	O	OA3	65	O	OA14
6	I	IA14	26	I	IA3	46	O	OA2	66	O	CDWR
7	I	IA13	27	I	IA2	47	O	OA1	67	O	IOS0
8	I/O	PD7	28	I	IA1	48	O	OA0	68	O	IOS1
9	I/O	PD6	29	I	IA0	49	I/O	D0	69	O	IOS2
10	I/O	PD5	30	I	MREQ	50	I/O	D1	70	O	IOS3
11	I/O	PD4	31	I	MODE	51	I/O	D2	71	O	IOS4
12	---	VSS	32	---	VSS	52	---	VSS	72	---	VSS
13	I/O	PD3	33	---	VDD	53	I/O	D3	73	---	VDD
14	I/O	PD2	34	I	IOST	54	I/O	D4	74	O	IOS5
15	I/O	PD1	35	I	R/W	55	I/O	D5	75	O	MS00
16	I/O	PDO	36	O	MRD	56	I/O	D6	76	O	MS01
17	I	IA12	37	O	MWR	57	I/O	D7	77	O	MS02
18	I	IA11	38	O	IORD	58	O	CDCS	78	O	MS03
19	I	IA10	39	O	IOWR	59	O	OA10	79	O	MS06
20	I	IA9	40	O	OA12	60	O	CDRD	80	O	MS07

μ PD70216L-10 (CPU)
PIN ASSIGNMENT

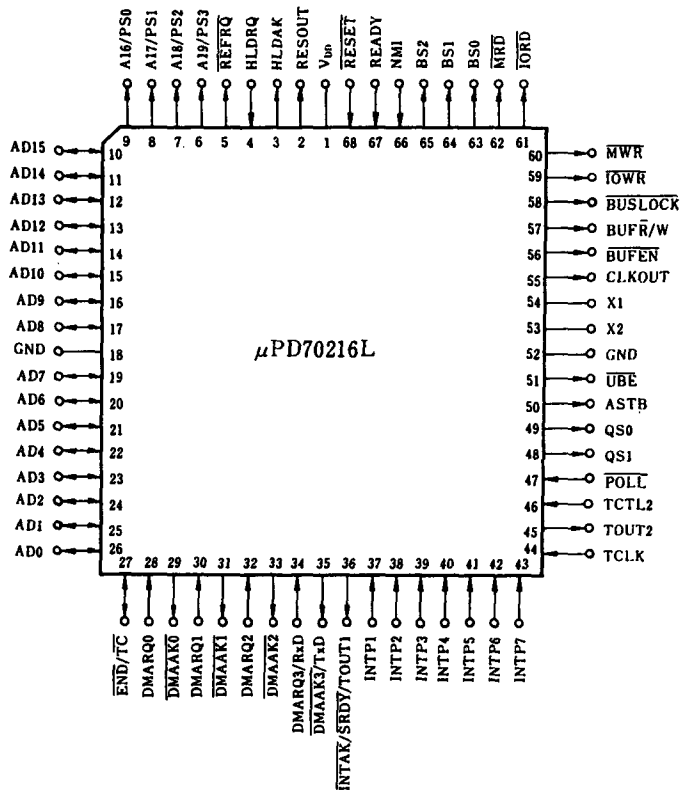

μ PD70216 INTERNAL BLOCK DIAGRAM

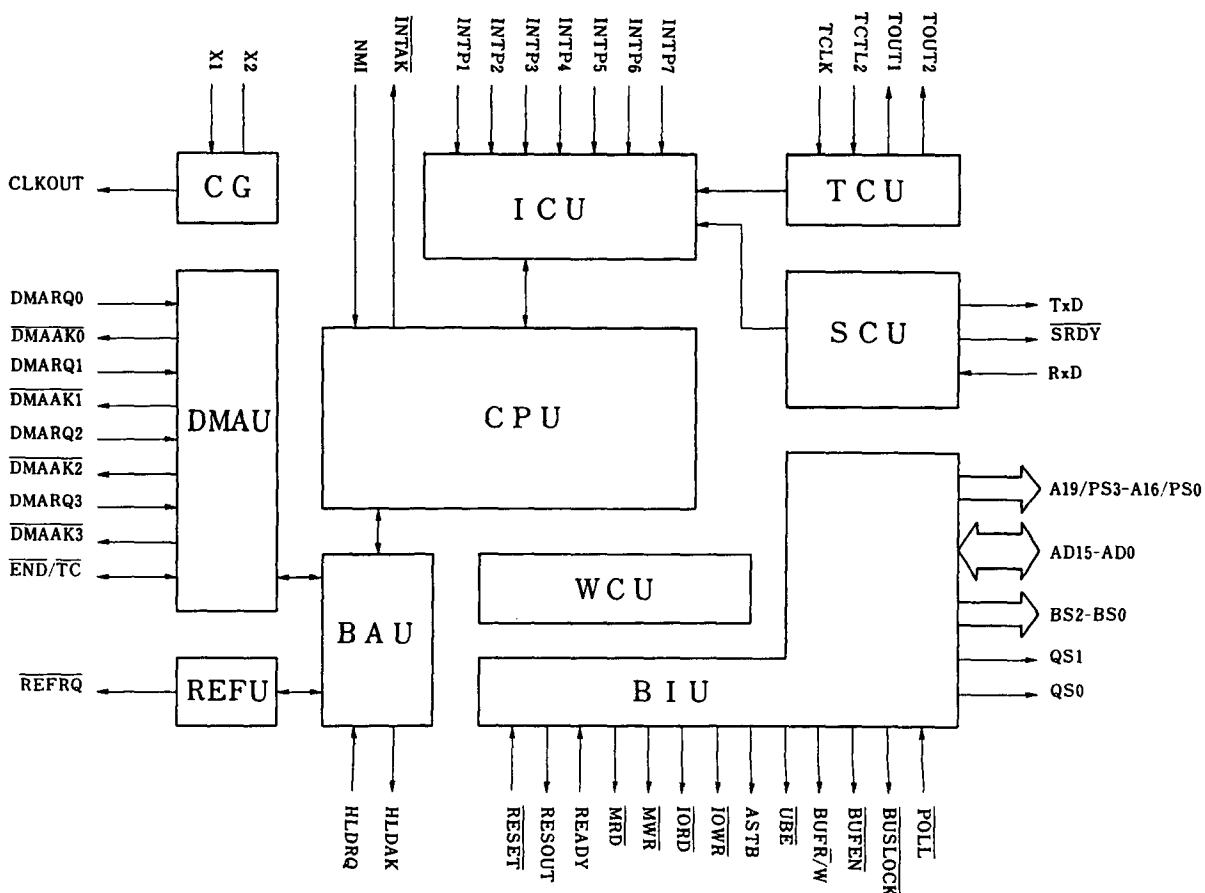

μ PD70216L-10 (CPU)

PIN FUNCTION

PIN NAME	I/O	FUNCTION
AD15-ADO	I/O	Address Bus/Data Bus
A19/PS3-A16/PS0	0	Address / Processor Status
REFRQ	0	Refresh Request
HLDRQ	I	Hold Request
HLDACK	I	Hold Acknowledge
RESET	I	Reset
RESOUT	0	Reset Output
READY	I	Ready
NMI	I	Non Maskable Interrupt
MRD	0	Memory Read Strobe
MWR	0	Memory Write Strobe
IOR	0	I/O Read Strobe
IOWR	0	I/O Write Strobe
ASTB	0	Address Strobe
UBE	0	Upper Byte Enable
BUSLOCK	0	Bus Lock
POLL	I	Poll
BUFR/W	0	Buffer Read/Write
BUFEN	0	Buffer Enable
X2-X1	I	Crystal IN
CLKOUT	0	Clock Output
BS2-BS0	0	Bus Status
QS1-QS0	0	Queue Status
TOUT2	0	Timer Output 2
TCTL2	I	Timer Control 2
TCLK	I	Timer Clock
INTP7-INTP1	I	Interrupt from Peripherals
INTACK	0	Interrupt Acknowledge
TxD	0	Transmit Data
RxD	I	Receive Data
DMAACK2-DMAACK0	0	DMA Acknowledge 2-0
DMARQ2-DMARQ0	I	DMA Request 2-0
END/TC	I/O	End/Terminal Count
VDD	-----	-----
GND	-----	-----
IC	-----	-----

CHECK POINT FOR μ PD70216L-10

1. INTP3 (39pin)

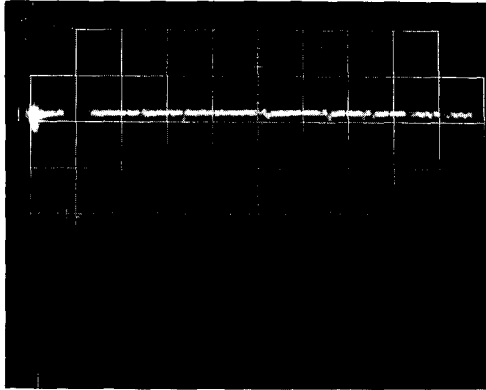

2V/20uS div

2. CLKOUT (55pin)

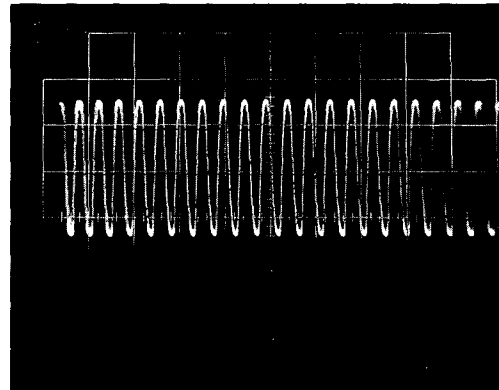

2V/0.2uS div

3. REFRQ (5pin)

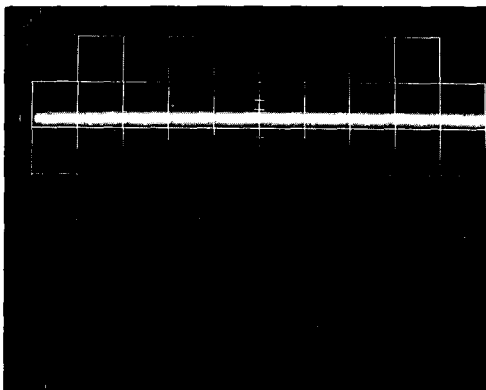

2V/20uS div

4. UBE (51pin)

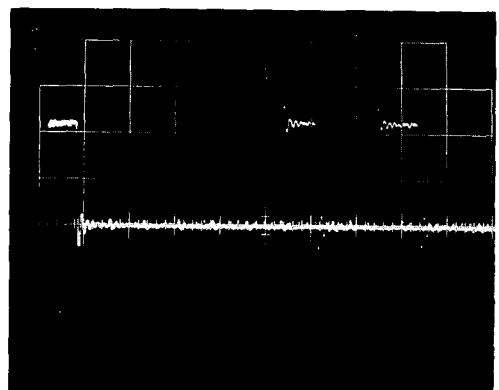

2V/0.5uS div

5. IOWR (59pin)

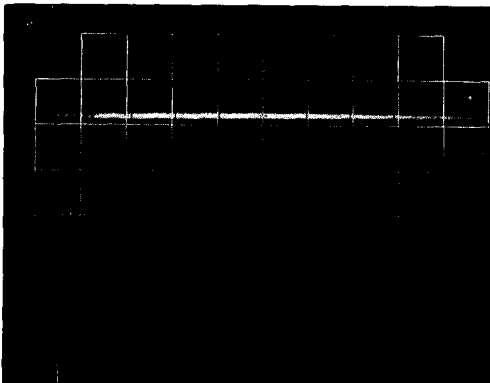

2V/0.5uS div

6. IORD (61pin)

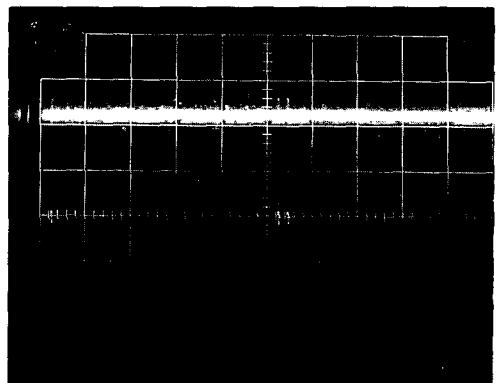

2V/20uS div

7.MWR (60pin)

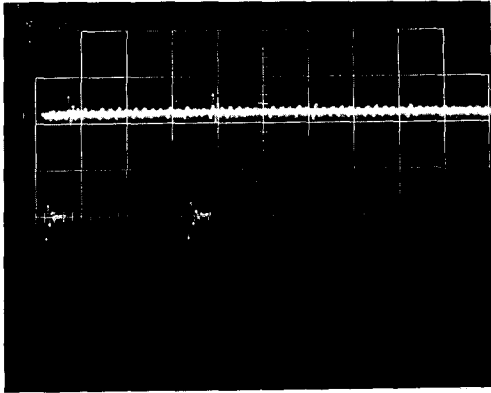

2V/2uS div

8.MRD (62pin)

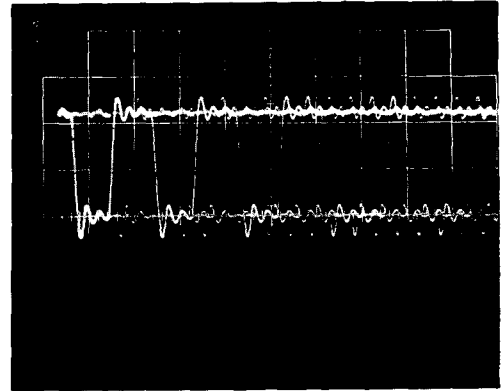

2V/0.2uS div

9.ASTB (50pin)

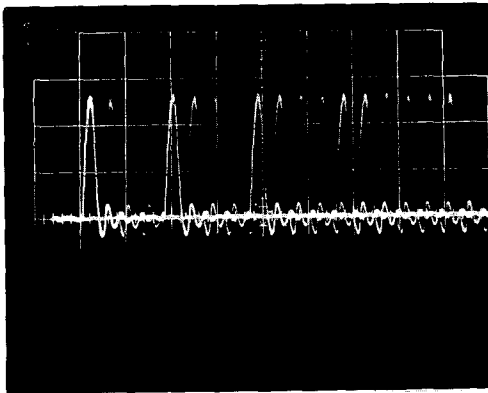

2V/0.2uS div

FOR HARNESSES

HNS-1791

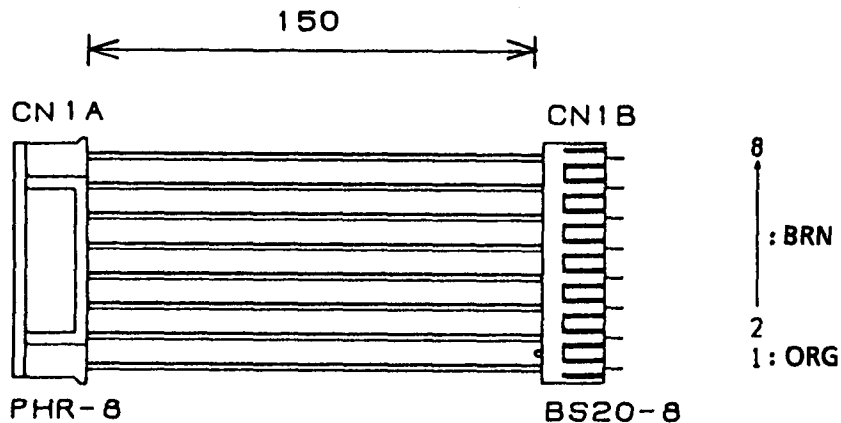

HNS-1792

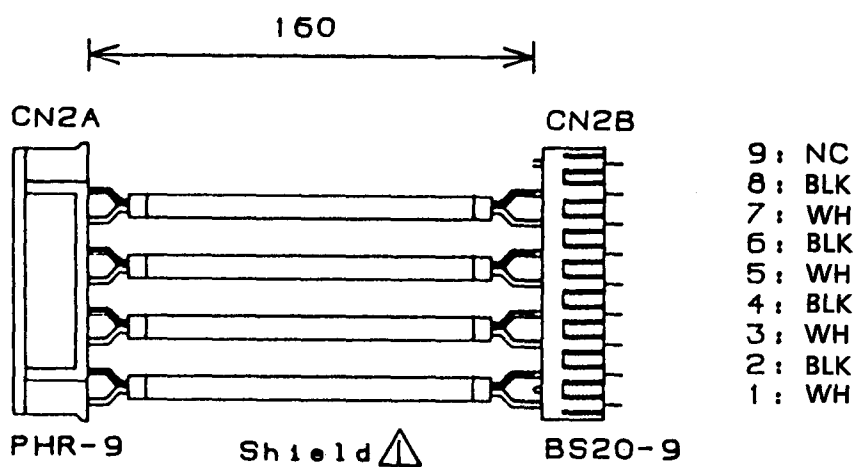

HNS-1793

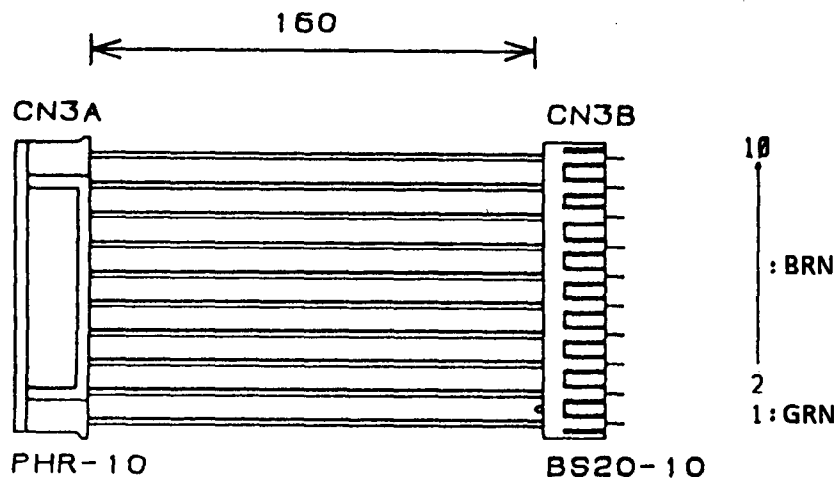

HNS-1794

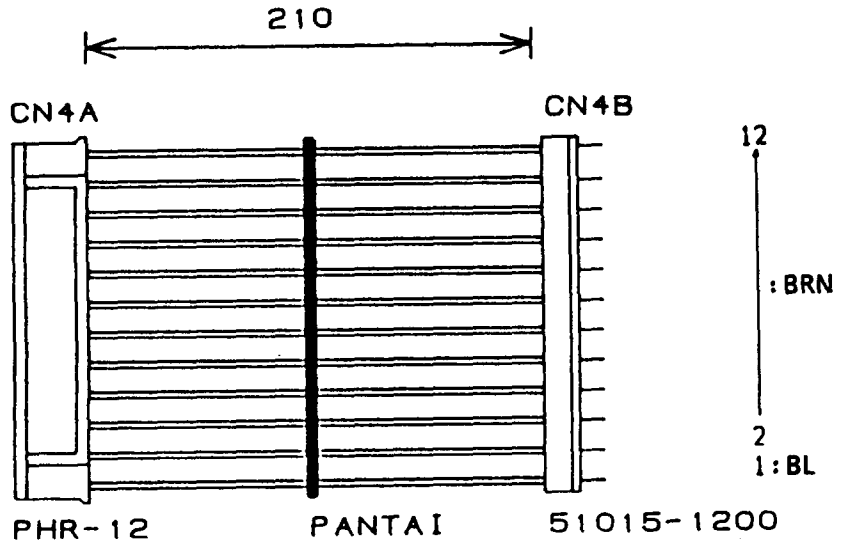

HNS-1795

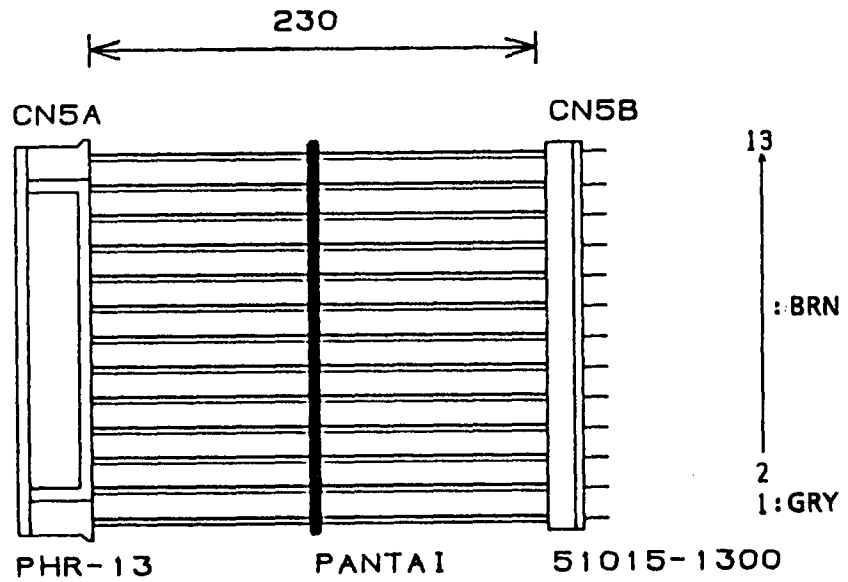

HNS-1796

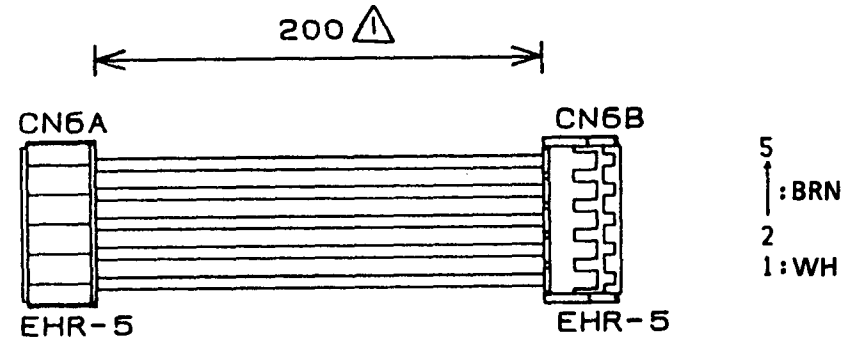

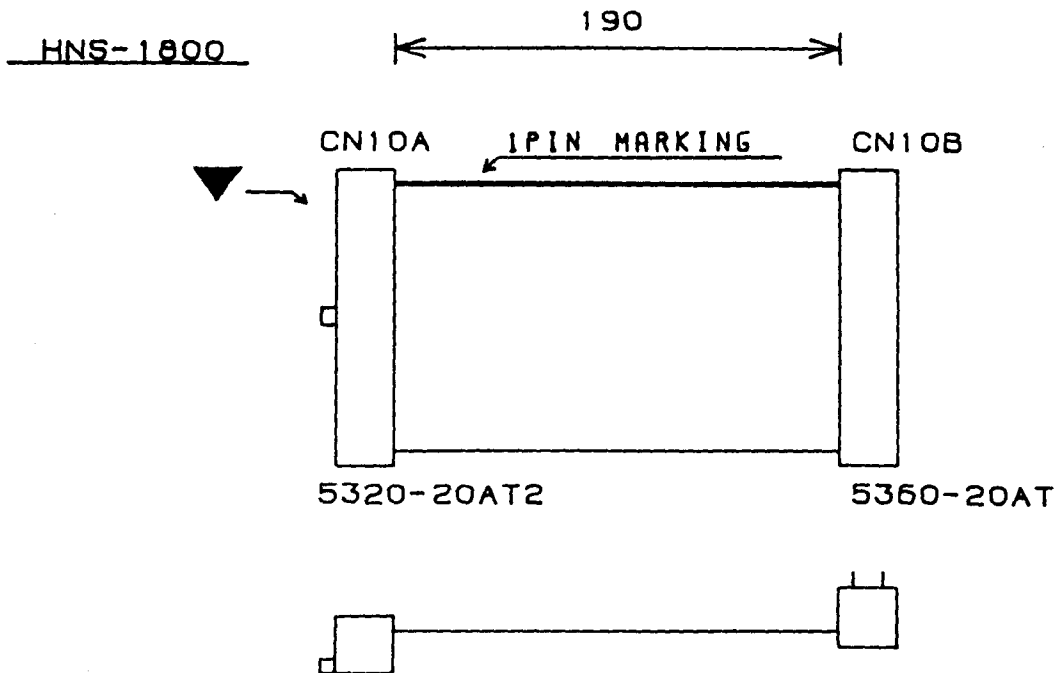
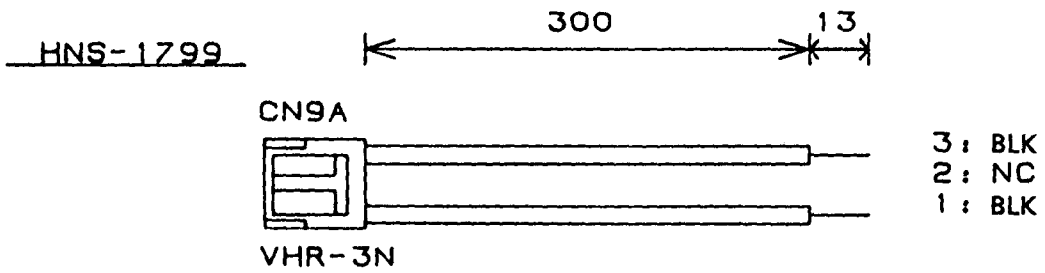
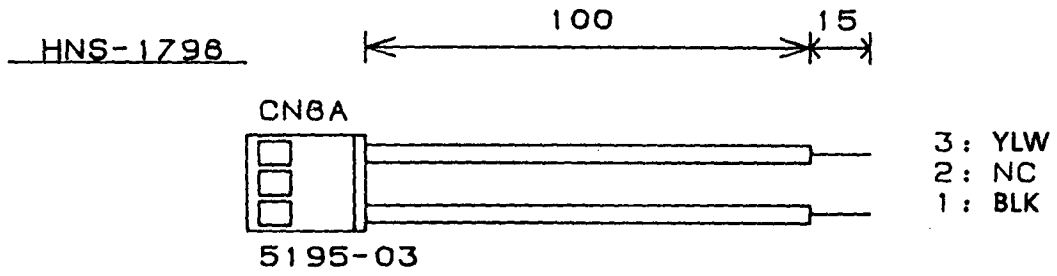
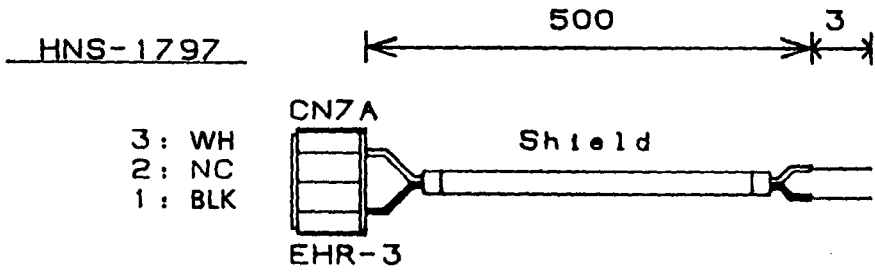

8. PARTS LIST

PART CODE	PART NAME/SPECIFICATION	P.C.BOARD	NOTE	Q'TY
001157600	P.C. BOARD ASSEMBLY KLM-1576	1576		1
001157700	P.C. BOARD ASSEMBLY KLM-1577/78/79	1577-79		1
002158000	POWER SUPPLY UNIT KLM-1580 CSA/JU	M.PART	117US	1
		M.PART	100JP	1
		M.PART	117EX	1
		M.PART	117CN	1
002158100	POWER SUPPLY UNIT KLM-1581 E	M.PART	220GE	1
		M.PART	240UK	1
		M.PART	230SC	1
		M.PART	230WG	1
		M.PART	230SE	1
		M.PART	230FR	1
		M.PART	230GE	1
		M.PART	240AF	1
		M.PART	240AU	1
		M.PART	240GE	1

139010012	BLOCK R RGLD5X103J 10K	1576		1
139010013	BLOCK R RGLD8X103J 10K	1576		2
139010014	BLOCK R RGLD8X472J	1576		2

140010012	BLOCK CR CRD604 (100 OHM 300PF)	1576		4

184050222	FUSE R RF73B2ATD 22 OHM J	1576		3

219401400	EMI FILTER DST310-92D223S50	1576		3

264003456	PPC 100V 5600PF J	APSV	1576	4

304000070	TR 2SA812-T1 (M5-7)	1576		1
304020150	TR 2SC1623-T1B (L7)	1576		1
304020230	TR 2SC3661-TA/TB(3K)	1576		4
304030130	TR FA1A4M-T1B	1576		8
304030140	TR FN1A4M-T1B	1576		5

304060070	FET 2SK433-T12-1C	1576		4

312007800	LED GL3HD8	1577-79		12
312010900	LED GL3ED8	1577		1

313002400	LCD DMF5005NSU-SEW10	M.PART		1

314000300	DIODE 1S-2473 T-77	1577		37
314001400	DIODE RLS-73 TE-11	1576		8
315000500	DOUBLE DIODE MC-2840-T12-1	1576		2

320001261	IC UPD71055GB-10-3B4	1576	PP1	1
320001283	IC UPD65016GF-058-3BA	1576	MAP260	1
320001393	IC UPD70216GF-10-3B9	1576	CPU	1

PART CODE	PART NAME/SPECIFICATION	P. C. BOARD	NOTE	Q'TY
320003202	IC TC511664BZ-10	1576	S_RAM	1
320011026	IC M5216L-600Y	1576	OP. AMP	1
320011141	IC M5M27C201K-15	1576	EP_ROM	1
320011152	IC M37450M4-616FP	1576	KSP	1
320012052	IC MB87405PF (QFP120)	1576	MDE	1
320012066	IC MB81464-10PSZ (ZIP)	1576	D_RAM	5
320012072	IC MB623147PF (QFP80)	1576	MAP25	1
320012084	IC MB87726PF (QFP160)	1576	TG88	1
320012085	IC MB87727PF (QFP120)	1576	DF88	1
320012092	IC MB635107PF-G-BND	1576	WS89	1
320012120	IC MBM27C1001-15Z-G	1576	EP_ROM	1
320036005	IC PCM55HP	1576	DAC	1
324001006	IC UPD74HCU04GS-E2 (SOP)	1576	HC-MOS	1
324001018	IC UPD74HC4053GS-E2(SOP)	1576	HC-MOS	3
324001034	IC UPD23C8001EGW-338-E2	1576	WAVE ROM	1
324001035	IC UPD23C8001EGW-339-E2	1576	WAVE ROM	1
324001037	IC UPD43256AGU-10/12L-E2	1576	S_RAM	3
324004004	IC HD74HC32FPER	1576	HC-MOS	1
324004012	IC HD74HC08FPER	1576	HC-MOS	1
324004050	IC HD74HC138FPER	1576	HC-MOS	1
324004092	IC HD74HC245FPER	1576	HC-MOS	1
324009004	IC NJM78L05UA	1576	REGULATOR	1
324009005	IC NJM79L05UA	1576	REGULATOR	1
324009013	IC NJM2068MD-TE3	1576	OP. AMP	8
324011002	IC M5223FP-600C (8P SOP)	1576	OP. AMP	1
324011005	IC M5238FP-600C (8PSOP)	1576	OP. AMP	3
324011006	IC M5218FP-600C (8PSOP)	1576	OP. AMP	1
324011013	IC M62021FP-600C	1576	RESET	1
324011015	IC M74HC05FP-31B (SOP)	1576	HC-MOS	1
324012002	IC MB838000-20PF-G-4A7-EF	1576	WAVE ROM	1
324012003	IC MB838000-20PF-G-4A8-EF	1576	WAVE ROM	1
324012004	IC MB838000-20PF-G-4A9-EF	1576	WAVE ROM	1
324012005	IC MB838000-20PF-G-5A0-EF	1576	WAVE ROM	1
324013001	IC LH531AP6	1576	MASK ROM	1

334000500	SB COIL SBT-0260 TF	1576		1
		1577-79		15

334000600	PHOTO COUPLER PC-410K-TP	1576		1

335006000	CRYSTAL OSC. AT-49 20.00MHZ	1576		1
335006600	CRYSTAL OSC. AT-49 32MHZ	1576		1

350002347	SEMI FIXED VR RH0615C S4 47K	1576		1
362005300	VR RK0971220045A 10KBX2	1577-79		1
365009000	SLIDE VR RS30111AC019A 10KB(X-142)	1577-79		1

375006100	POWER SW SDDLBI	M. PART		1
375010500	TOUCH SW EVQ-PAC09K-A	1577-79		37

PART CODE	PART NAME/SPECIFICATION	P. C. BOARD	NOTE	Q'TY
400012500	INVERTER TRANSFORMER TA-042	1576		1
454008000	PHONE JACK YKB21-5138	1577-79		7
471060500	CONNECTOR TOP B5B-EH-A	1576		1
471070300	CONNECTOR TOP B3B-PH-K-S	1576		1
471070800	CONNECTOR TOP B8B-PH-K-S	1576		1
471070900	CONNECTOR TOP B9B-PH-K-S	1576		1
471071000	CONNECTOR TOP B10B-PH-K-S	1576		1
471071200	CONNECTOR TOP B12B-PH-K-S	1576		1
471071300	CONNECTOR TOP B13B-PH-K-S	1576		1
474011300	CARD CONNECTOR HGC0338-01-010	1576		1
474014400	HEADER 20P 5332-20T2	1576		1
474015400	CARD CONNECTOR FCN-565P068-G/C	1576		1
475001791	HARNESS HNS-1791 (BOARD IN)	1577-79		1
475001792	HARNESS HNS-1792 (BOARD IN)	1577-79		1
475001793	HARNESS HNS-1793 (BOARD IN)	1577-79		1
475001794	HARNESS HNS-1794 (BOARD IN)	1577-79		1
475001795	HARNESS HNS-1795 (BOARD IN)	1577-79		1
475001796	HARNESS HNS-1796	M.PART		1
475001797	HARNESS HNS-1797	M.PART		1
475001798	HARNESS HNS-1798	M.PART		1
475001799	HARNESS HNS-1799	M.PART		1
475001800	HARNESS HNS-1800	M.PART		1
480001324	IC SOCKET 32P DICF-32CS-E	1576		2
480010200	3P DIN JACK SOCKET YKF51-5046	1577-79		1
500012900	X-631 RUBBER SPACER	M.PART		1
500018300	RUBBER FOOT 3x22x3	M.PART		4
520001700	LITHIC BATTERY CR2032	1576		1
525000400	EMI FERRITE 2643-480102	M.PART		1
525000800	DATA LINE FILTER ESD-R-16	M.PART		1
540012300	INLET SOCKET PA-125-BS	M.PART	240UX	1
540012400	INLET SOCKET PA-125-10	M.PART	240GE	1
		M.PART	220GE	1
		M.PART	240AU	1
		M.PART	117EX	1
		M.PART	100JP	1
		M.PART	117CN	1
		M.PART	230GE	1
		M.PART	240AF	1
		M.PART	230FR	1
		M.PART	117US	1
		M.PART	230SC	1

PART CODE	PART NAME/SPECIFICATION	P. C. BOARD	NOTE	Q'TY
540012400	INLET SOCKET PA-125-CU	M. PART	230WG	1
		M. PART	230SE	1
575015000	LED SPACER LS-15-6.5 L=6.5mm	1577-79		1
575015900	LED SPACER LS-15-8 L=8mm	1577-79		12
600003200	AC CORD UC-948-J02	M. PART	117EX	1
600003300	AC CORD UC-953-J01	M. PART	117US	1
		M. PART	117CN	1
600003500	AC CORD SC-321-J01	M. PART	240AU	1
600003800	AC CORD DC-480-J01	M. PART	100JP	1
600004700	AC CORD EC-652-E03	M. PART	230FR	1
		M. PART	230GE	1
		M. PART	230WG	1
		M. PART	240AF	1
		M. PART	230SC	1
		M. PART	240GE	1
		M. PART	220GE	1
600004800	AC CORD EC-472-J01	M. PART	230SE	1
600004900	AC CORD BH-322-J01	M. PART	240UK	1
620022500	SLIDE VR KNOB	M. PART		1
620023100	X-952 POWER SW KNOB	M. PART		1
620023600	X-943 VR KNOB	M. PART		1
630017200	X-142 LCD WINDOW	M. PART		1
640094800	X-631R UPPER CASE	M. PART		1
641019900	X-052 VR SHIELD	1577-79		1
641021900	X-943 JACK PLATE	M. PART		1
641022500	RACK MOUNT ADAPTER	M. PART		2
641027200	X-142 FRONT PANEL ASSEMBLY	M. PART		1
641027300	X-142 FRONT CHASSIS	M. PART		1
641027400	X-142 LOWER CASE	M. PART		1
646039400	X-011/012 CARD GUIDE	M. PART		1
646039500	X-011/012 CARD SLOT	M. PART		1
649007400	BATTERY HOLDER	1576		1

VAROITUS

Paristo voi räjähtää, jos se on virheellisesti asennettu.
Vaihda paristo ainoastaan laitevalmistajan suosittelemaan tyyppiin. Hävitä käytetty paristo valmistajan ohjeiden mukaisesti.

ADVARSEL!

Lithiumbatteri – Eksplosionsfare ved fejlagtig handtering.
Udskiftning må kun ske med batteri af samme fabrikat og type.
Levér det brugte batteri tilbage til leverand ø ren.

ADVERSEL

Lithiumbatteri – Eksplosjonsfare.
Ved utskifting benyttes kun batteri som anbefalt av apparatfabrikanten.
Brukt batteri returneres apparatleverand ø ren.

VARNING

Explosionsfara vid felaktigt batteribyte.
Använd samma batterityp eller en ekvivalent typ som rekommenderas av apparattillverkaren.
Kassera använt batteri enligt fabrikantens instruktion.

CAUTION

Danger of explosion if battery is incorrectly replaced .
Replace only with the same or equivalent type recommended by the equipment manufacturer .
Discard used batteries according to manufacturer 's instructions.

KORG

KORG INC. 15-12, Shimotakaido 1-chome, Suginami-ku, Tokyo 168

© KORG INC. 1992

0402 CEH. PRINTED IN JAPAN ①