

登録済

# CONTROL SYNTHESIZER

# AN1X

## SERVICE MANUAL

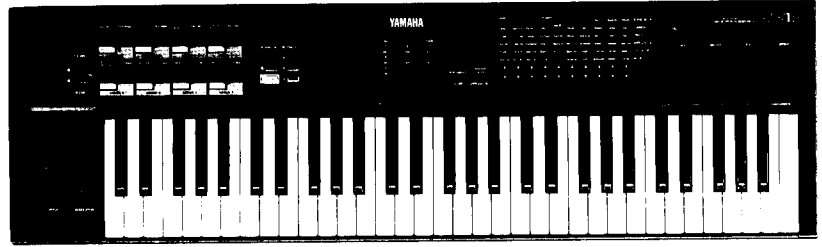

### ■ CONTENTS (目次)

SPECIFICATIONS (総合仕様) .....	2/3
PANEL LAYOUT (パネルレイアウト) .....	4
CIRCUIT BOARD LAYOUT (ユニットレイアウト) .....	6
BLOCK DIAGRAM (ブロックダイアグラム) .....	8
DISASSEMBLY PROCEDURE (分解手順) .....	10
LSI PIN DESCRIPTION (LSI端子機能表) .....	14
IC BLOCK DIAGRAM (ICブロック図) .....	18
CIRCUIT BOARDS (シート基板図) .....	20
TEST PROGRAM (テストプログラム) .....	28/36
MIDI DATA FORMAT (MIDIデータフォーマット) .....	44
ERROR MESSAGE (エラーメッセージ) .....	52
MIDI IMPLEMENTATION CHART .....	53
PARTS LIST	

SY 011364

19970501-148000

YAMAHA CORP.

HAMAMATSU, JAPAN

1.97K-666 D<sub>H</sub> Printed in Japan '97.5

### IMPORTANT NOTICE

This manual has been provided for the use of authorized Yamaha Retailers and their service personnel. It has been assumed that basic service procedures inherent to the industry, and more specifically Yamaha Products, are already known and understood by the users, and have therefore not been restated.

**WARNING:** Failure to follow appropriate service and safety procedures when servicing this product may result in personal injury, destruction of expensive components and failure of the product to perform as specified. For these reasons, we advise all Yamaha product owners that all service required should be performed by an authorized Yamaha Retailer or the appointed service representative.

**IMPORTANT:** This presentation or sale of this manual to any individual or firm does not constitute authorization, certification, recognition of any applicable technical capabilities, or establish a principal-agent relationship of any form.

The data provided is believed to be accurate and applicable to the unit(s) indicated on the cover. The research engineering, and service departments of Yamaha are continually striving to improve Yamaha products. Modifications are, therefore, inevitable and changes in specification are subject to change without notice or obligation to retrofit. Should any discrepancy appear to exist, please contact the distributor's Service Division.

**WARNING:** Static discharges can destroy expensive components. Discharge any static electricity you body may have accumulated by grounding yourself to the ground buss in the unit (heavy gauge black wires connect to this buss.)

**IMPORTANT:** Turn the unit **OFF** during disassembly and parts replacement. Recheck all work before you apply power to the unit.

### LITHIUM BATTERY HANDLING

This product uses a lithium battery for memory back-up.

**WARNING:** Lithium batteries are dangerous because they can be exploded by improper handling. Observe the following precautions when handling or replacing lithium batteries.

- Leave lithium battery replacement to qualified service personnel.
- Always replace with batteries of the same type.
- When installing on the PC board by soldering, solder using the connection terminals provided on the battery cells. Never solder directly to the cells. Perform the soldering as quickly as possible.
- Never reverse the battery polarities when installing.
- Do not short the batteries.
- Do not attempt to recharge these batteries.
- Do not disassemble the batteries.
- Never heat batteries or throw them into fire.

#### ADVARSEL!

Lithiumbatteri-Eksplosionsfare ved fejlagtig håndtering. Udskiftning må kun ske med batteri af samme fabrikat og type. Levér det brugte batteri tilbage til leverandøren.

#### VARNING

Explosionsfara vid felaktigt batteribyte.

Använd samma batterityp eller en ekvivalent typ som rekommenderas av apparattillverkaren.

Kassera använt batteri enligt fabrikantens instruktion.

#### VAROITUS

Paristo voi räjähtää, jos se on virheellisesti asennettu.

Vaihda paristo ainoastaan laitevalmistajan suosittelemaan tyyppiin.

Hävitätä käytetty paristo valmistajan ohjeiden mukaisesti.

The following information complies with Dutch Official Gazette 1995. 45; ESSENTIALS OF ORDER ON THE COLLECTION OF BATTERIES.

- Please refer to the disassembly procedure for the removal of Back-up Battery.
- Leest u voor het verwijderen van de backup batterij deze beschrijving.

### WARNING: CHEMICAL CONTENT NOTICE!

The solder used in the production of this product contains LEAD. In addition, other electrical/electronic and/or plastic (where applicable) components may also contain traces of chemicals found by the California Health and Welfare Agency (and possibly other entities) to cause cancer and/or birth defects or other reproductive harm.

**DO NOT PLACE SOLDER, ELECTRICAL/ELECTRONIC OR PLASTIC COMPONENTS IN YOUR MOUTH FOR ANY REASON WHAT SO EVER!**

Avoid prolonged, unprotected contact between solder and your skin! When soldering, do not inhale solder fumes or expose eyes to solder/flux vapor!

If you come in contact with solder or components located inside the enclosure of this product, wash your hands before handling food.

#### ■ WARNING

Components having special characteristics are marked  $\triangle$  and must be replaced with parts having specification equal to those originally installed.

$\triangle$ 印の商品は、安全を維持するために重要な部品です。交換する場合は、安全のため必ず指定の部品をご使用下さい。

## ■ SPECIFICATIONS

<b>KEYBOARD</b>	61Keys (Initial/After Touch),
<b>STONE GENERATOR</b>	Analog Physical Modeling, 2 VCOs (Sync, FM)/Ring Mod/Noise/2 LFOs/PEG/VCF (FEG)/VCA (AEG)
<b>POLYPHONY</b>	10 notes (maximum)
<b>MULTI TIMBRES</b>	2 timbres maximum (with polyphony of 5 + 5 notes)
<b>EFFECT</b>	Variation: 14, EQ: 1 (Stereo 3-Band), Delay: 5, Reverb: 8
<b>VOICE MEMORIES</b>	User 128
<b>ARPEGIATOR</b>	30 Preset patterns
<b>STEP SEQUENCER</b>	Voice Pattern for each Voice plus 128 User Patterns
<b>FREE EG</b>	No. of Tracks : 4 Parameter tracks per voice (16.0 sec maximum per track)
<b>CONTROLLERS</b>	Pitch Bend Wheel, Modulation Wheel (Assignable), X-Z Ribbon Controller (Assignable) Edit Rotary Switch (6 segment), Control Knobs (with push-switch) x 8 (Assignable), Volume Knobs
<b>PANEL SWITCHES</b>	Knob Parameter Group Select x 8 (PEG/LFO, VCO1, VCO2, SYNC/FM, MIX/VCF, VCF, VCA, ASSIGN), Data x 20, Layer x 1, Portamento x 1 (on/off), Arpeg/SEQ x 1 (on/off), Store x 1, Voice Select x 2 (-/NO, +/YES/ENTER), Data Entry x 10 (0-9), Scene x 2 (Scene1, 2)
<b>DISPLAY</b>	LCD Custom (15 Characters with LED Backlight), LED Scene x 2 (Red), LED Knob Parameter Group Select x 8 (Red)
<b>CONNECTORS</b>	Head Phones (L / R Stereo), Stereo Output L (Mono) / R, Phone x 2, Foot Controller (Assignable), Foot Volume (Assignable), Footswitch (Assignable), MIDI IN / OUT / THRU
<b>OUTPUT LEVEL</b>	Phones -2.9 ± 2.0dBm (33 Ω), Stereo Output +4.0 ± 2.0dBm (10kΩ)
<b>POWER REQUIREMENTS</b>	AC Adaptor PA-3B or equivalent
<b>DIMENSIONS</b>	986 (W) x 285 (D) x 103 (H) mm
<b>WEIGHT</b>	7.5 kg
<b>ACCESSORIES</b>	Owner's Manual, Data List Book, AC Adaptor (PA-3B)

## ■ 総合仕様

<b>鍵盤</b>	61鍵(イニシャル、アフタータッチ付き)
<b>音源</b>	アナログフィジカルモデリング、2VCO (Sync, FM)/Ring Mod./ Noise/2LFO/PEG/VCF (FEG)/VCA (AEG)
<b>最大同時発音数</b>	10音(最大)
<b>マルチティンバー数</b>	2音色(1音色につき最大5音)
<b>エフェクター</b>	バリエーション: 14タイプ、イコライザー: 1タイプ (ステレオ3バンド)、 ディレイ: 5タイプ、リバーブ: 8タイプ
<b>ボイスメモリー</b>	ユーザー 128
<b>アルペジエーター</b>	30パターン
<b>ステップシーケンサー</b>	256パターン(ボイス128、ユーザー128)
<b>フリーEG</b>	1ボイスは4トラック(最大16秒/トラック)
<b>コントローラー</b>	ピッチベンドホイール、モジュレーションホイール(アサイン可能)、 リボンコントローラーX、Z (アサイン可能)、エディットロータリースイッチ(6セグメント)、 データノブ: 8(アサイン可能)、ボリュームノブ
<b>パネルキー</b>	ノブパラメーターグループ: 8 (PEG/LFO、VCO1、VCO2、SYNC/FM、MIX/VCF、 VCF、VCA、ASSIGN)、パラメーター▲/▼キー: 20、レイヤーキー、 ポルタメントキー、アルペジオ/シーケンスキー、ストアキー、 プログラムチェンジキー: 2 (-/No. +/Yes/Enter)、10キー(0~9)、シーンキー: 2
<b>ディスプレイ</b>	LCDカスタム(15キャラクターバックライト付き)、LEDシーン: 2、 LEDノブパラメーターグループ: 8
<b>接続端子</b>	Phones、Output L (Mono) / R、FOOT CONTROLLER (設定可能)、FOOT VOLUME (設定可能)、FOOT SWITCH (設定可能)、MIDI IN/OUT/THRU
<b>出力レベル</b>	Phones -2.9 ± 2.0dBm (33 Ω)、Stereo Output +4.0 ± 2.0dBm (10k Ω)
<b>電源</b>	電源アダプターPA-3B
<b>寸法</b>	986 (W) x 285 (D) x 103 (H) mm
<b>重量</b>	7.5 Kg
<b>付属品</b>	電源アダプターPA-3B 取扱説明書セット: 取扱説明書、データリスト 保証書

## ■ PANEL LAYOUT (パネルレイアウト)

### ● Front Panel (フロントパネル)

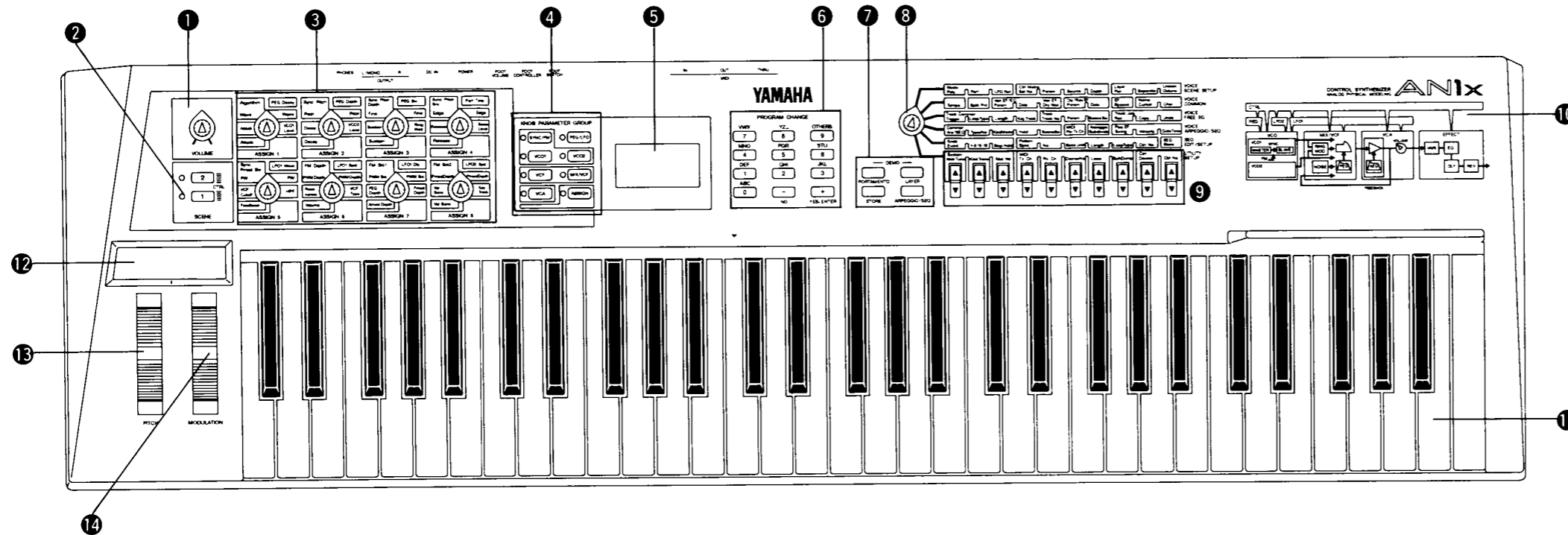

- ① [VOLUME] Knob
- ② [SCENE] switches
- ③ CONTROL knobs with push-switch (knob parameters)
- ④ KNOB PARAMETER GROUP switches
- ⑤ LCD
- ⑥ PROGRAM CHANGE keypad
- ⑦ [PORTAMENTO] switch  
[LAYER] switch  
[STORE] switch  
[ARPEGGIO/SEQ] switch
- ⑧ [EDIT ROTARY] switch
- ⑨ Parameter value [UP/DOWN] switches
- ⑩ Synthesis Block Diagram
- ⑪ Keyboard
- ⑫ [RIBBON] controller
- ⑬ [PITCH] wheel
- ⑭ [MODULATION] wheel

- ① VOLUME (ボリューム)ノブ
- ② SCENE (シーン) 1/2キー
- ③ コントロールノブ1~8
- ④ KNOB PARAMETER GROUP (ノブパラメーターグループ)キー
- ⑤ LCD
- ⑥ PROGRAM CHANGE (プログラムチェンジ)キーパッド
- ⑦ PORTAMENTO (ポルタメント)キー  
LAYER (レイヤー)キー  
STORE (ストア)キー  
ARPEGGIO/SEQ (アルペジエーター/シーケンサー)キー
- ⑧ ロータリースイッチ
- ⑨ Inc/Decパラメーターキー▲/▼キー
- ⑩ AN1xブロックダイアグラム
- ⑪ キーボード
- ⑫ リボンコントローラー
- ⑬ ピッチベンドホイール
- ⑭ モジュレーションホイール

### ● Rear Panel (リアパネル)

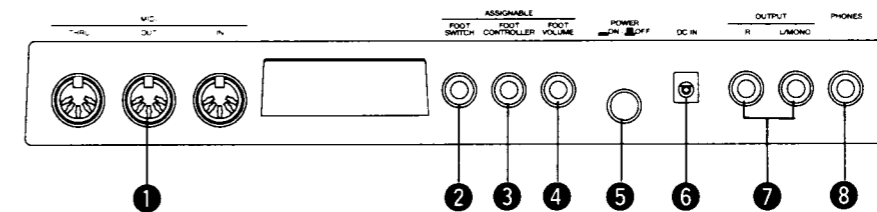

- ① MIDI terminals
- ② [FOOTSWITCH] jack
- ③ [FOOT CONTROLLER] jack
- ④ [FOOT VOLUME] jack
- ⑤ [POWER] switch
- ⑥ [DC IN] terminal
- ⑦ OUTPUT jacks
- ⑧ [PHONES] jack

- ① MIDI IN/OUT/THRU端子
- ② FOOT SWITCH (フットスイッチ)端子
- ③ FOOT CONTROLLER (フットコントローラー)端子
- ④ FOOT VOLUME (フットボリューム)端子
- ⑤ POWER (パワー)スイッチ
- ⑥ DC IN端子
- ⑦ OUTPUT L/MONO, R (アウトプット左/モノラル、右)端子
- ⑧ PHONES (ヘッドフォン)端子

■ **CIRCUIT BOARD LAYOUT (ユニットレイアウト)**

● **Bottom View (底板を開けて見た図)**

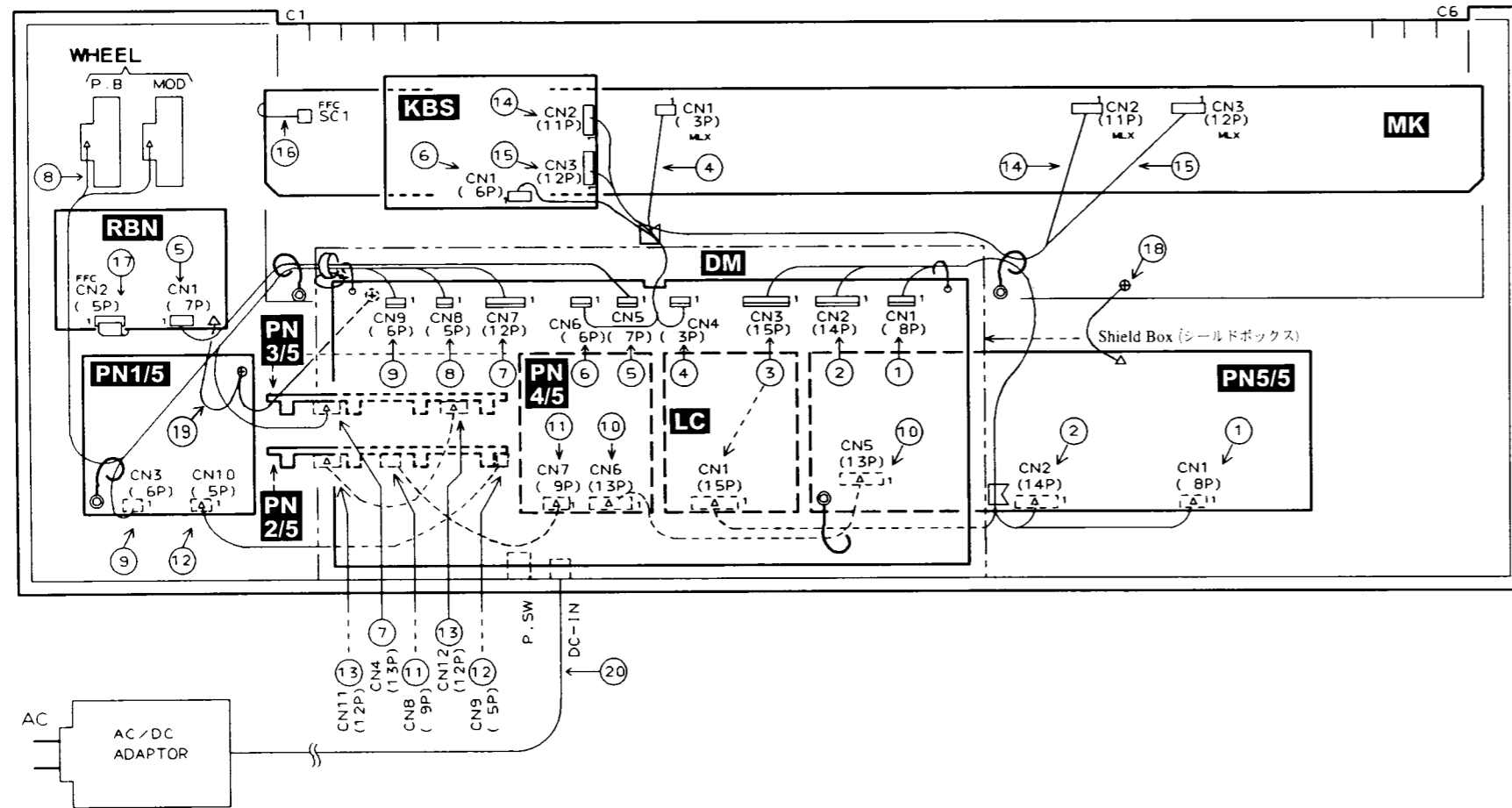

● **Wiring (基板結線図)**

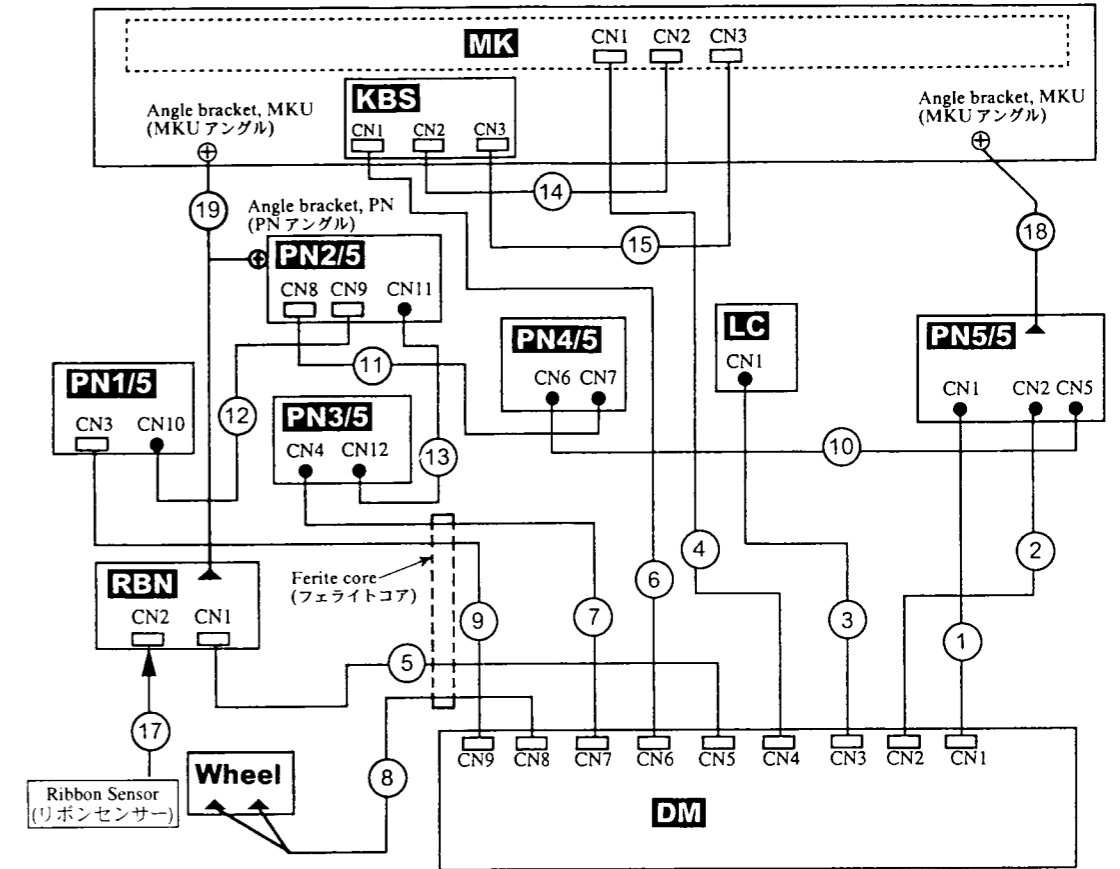

Location	PART NO.	CONNECTOR ASSEMBLY	DESTINATION		REMARK
①	VV97410	DS-KR	DM-CN1	PN(5/5)-CN1	8P/300L
②	VV97430	DS-KR	DM-CN2	PN(5/5)-CN2	14P/260L
③	VV97440	DS-KR	DM-CN3	LC-CN1	15P/400L
④	VY64470	PH-MK(A)	DM-CN4	MK-CN1	3P/120L
⑤	VK10580	KRD-KRD	DM-CN5	RBN-CN1	7P/300L
⑥	VK10060	KRD-KRD	DM-CN6	KBS-CN1	6P/150L
⑦	VV97420	DS-KR	DM-CN7	PN(3/5)-CN4	13P/250L
⑧	VU55440	WHEEL	DM-CN8	WHEEL	5P/400L
⑨	VY68100	MVR	DM-CN9	PN(1/5)-CN3	6P/260L
⑩	VU40610	DS-DS	PN(4/5)-CN6	PN(5/5)-CN5	13P/160L
⑪	VY98890	DS-KR	PN(2/5)-CN8	PN(4/5)-CN7	9P/160L
⑫	VY98880	DS-KR	PN(1/5)-CN10	PN(2/5)-CN9	5P/220L
⑬	VV97400	DS-DS	PN(2/5)-CN11	PN(3/5)-CN12	12P/160L
⑭	VY65590	PH-MK(C)	KBS-CN2	MK-CN2	11P/400L
⑮	VY65580	PH-MK(B)	KBS-CN3	MK-CN3	12P/440L
⑯		TOUCH SENSOR	MK-SC1	TOUCH SENSOR	
⑰		RIBBON SENSOR	RBN-CN2	RIBBON SENSOR	
⑱	VY98430	GND WIRE A	PN(5/5)-GND	GND	50L
⑲	VY99040	GND WIRE B	RBN-GND	GND	60-60L
⑳		AC ADAPTOR	DC-IN	AC ADAPTOR	

- : Connector (コネクタ)
- : Board-in connector (ボードインコネクタ)
- ▲ : Solder (半田付け)
- ⊕ : Screw (ネジ止め)

■ **WARNING**

Components having special characteristics are marked and must be replaced with parts having specification equal to those originally installed.

印の部品は、安全を維持するために重要な部品です。交換する場合は、安全のため必ず指定の部品をご使用下さい。

2NC-VV84830   
28C99-8811544

■ BLOCK DIAGRAM (ブロックダイアグラム)

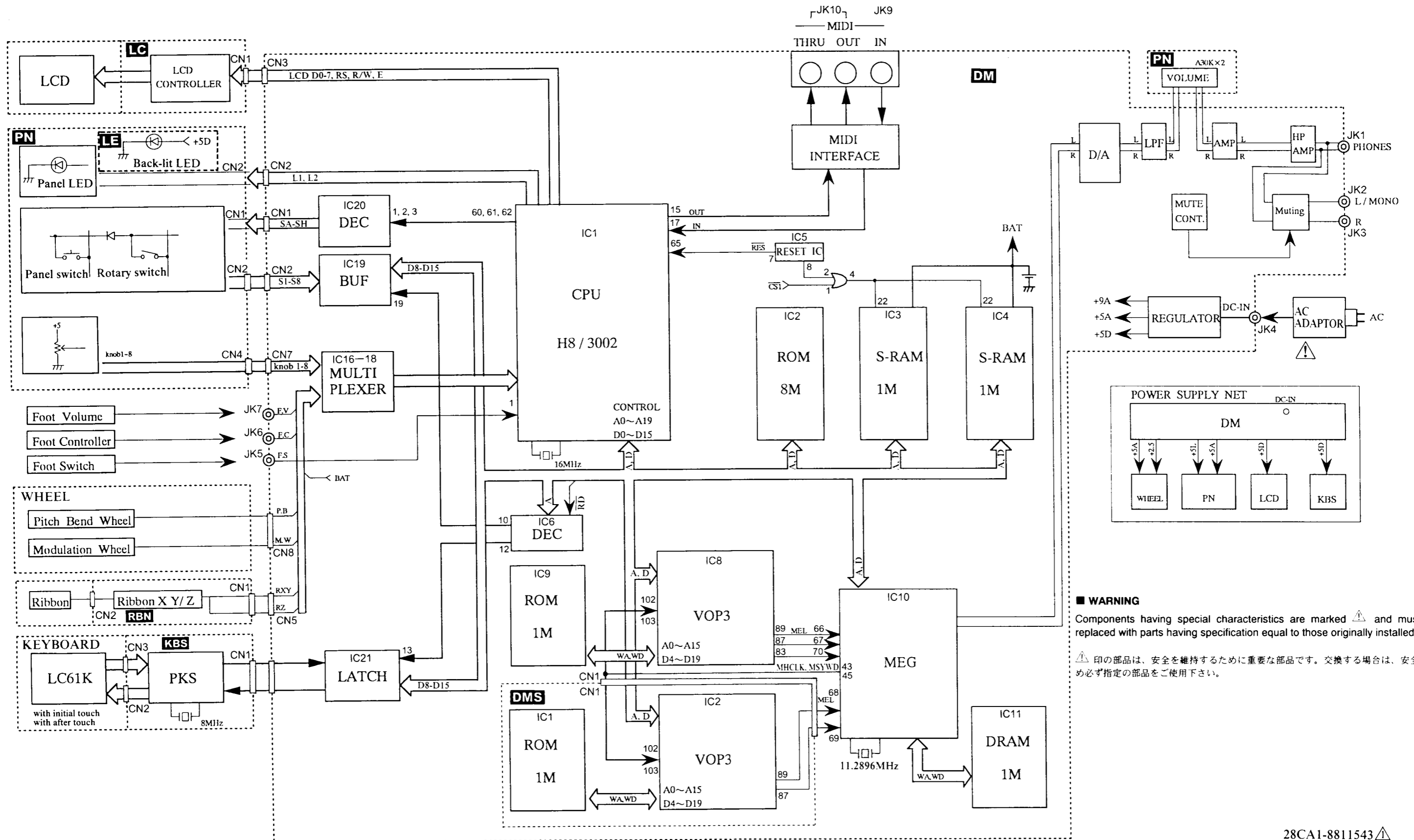

■ **WARNING**  
 Components having special characteristics are marked  and must be replaced with parts having specification equal to those originally installed.  
 印の部品は、安全を維持するために重要な部品です。交換する場合は、安全のため必ず指定の部品をご使用下さい。

## ■ DISASSEMBLY PROCEDURE (分解手順)

### 1. Bottom Assembly

- 1-1 Remove the thirty-three (33) screws marked [210]. Then the bottom assembly can be removed. (Fig. 1)

### 1. ボトム Ass'y

- 1-1 [210]のネジ 33 本をはずして、ボトム Ass'y を取り外します。(図 1)

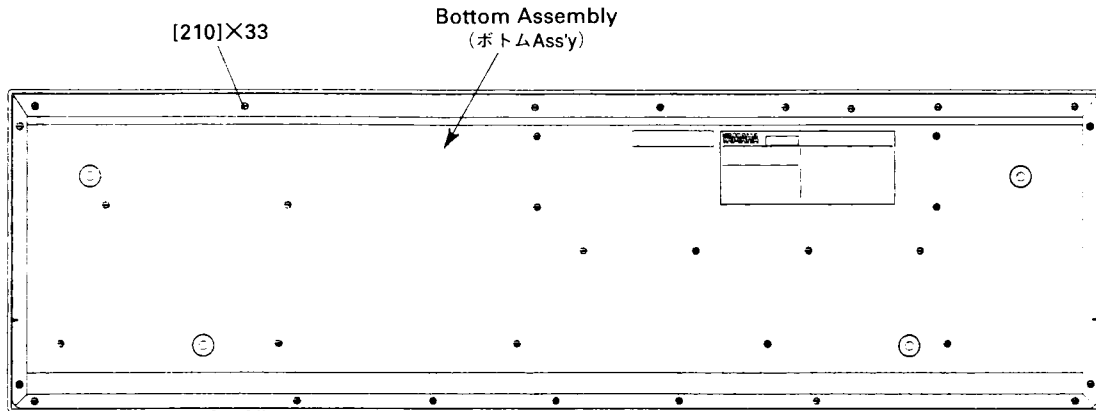

[210]: Bonding Tapping Screw-B 4.0X10 MFZN2BL (VJ254100) ボンディングBタイト

(Fig. 1)

### 2. KBS Circuit Board

- 2-1 Remove the bottom assembly. (See Procedure 1.)  
2-2 Remove the four (4) screws marked [170]. Then the KBS circuit board can be removed. (Fig. 2)

### 2. KBS シート

- 2-1 ボトム Ass'y を外します。(1 項参照)  
2-2 [170]のネジ 4 本を外して、KBS シートを取り外します。(図 2)

### 3. DM Circuit Board and DMS Circuit Board

- 3-1 Remove the bottom assembly. (See Procedure 1.)  
3-2 Remove the KBS circuit board. (See Procedure 2.)  
3-3 Remove the two (2) screws marked [90]. Then the shield box assembly can be removed. (Fig. 2)  
3-4 Remove the seven (7) screws marked [30A] and the four (4) screws marked [40A]. Then the DM circuit board with DMS circuit board can be removed. (Fig. 3)  
3-5 Press one of the two (2) heads of the circuit board supports marked [30B], and gently lift the DMS circuit board. Repeat this procedure with the remaining heads until you can remove the DMS circuit board. (Fig. 3)

### 3. DM シートと DMS シート

- 3-1 ボトム Ass'y を外します。(1 項参照)  
3-2 KBS シートを外します。(2 項参照)  
3-3 [90]のネジ 2 本を外して、シールドボックス Ass'y を取り外します。(図 2)  
3-4 [30A]のネジ 7 本と[40A]のネジ 4 本を外して、DMS シートの付いた DM シートを取り外します。(図 3)

- ※ The lithium battery is not a part of the DM circuit board. When you replace the DM circuit board, you should remove the lithium battery from the board, and put it back into the holder on the new board. (Fig. 4)  
※ You can remove the lithium battery by pushing the hook of the battery holder. (Fig. 4)

- 3-5 [30B]の基板サポート 2 本の先を一つずつつまみながら DMS シートを軽く引っぱって DM シートから DMS シートを取り外します。(図 3)  
※ リチウム電池は、DM シートの構成部品ではありません。DM シートを交換する際には、本体のシートからリチウム電池を取り外して新しいシートに取り付けて下さい。(図 4)  
※ 電池ホルダーのフックを押すと、リチウム電池を取り外すことができます。(図 4)

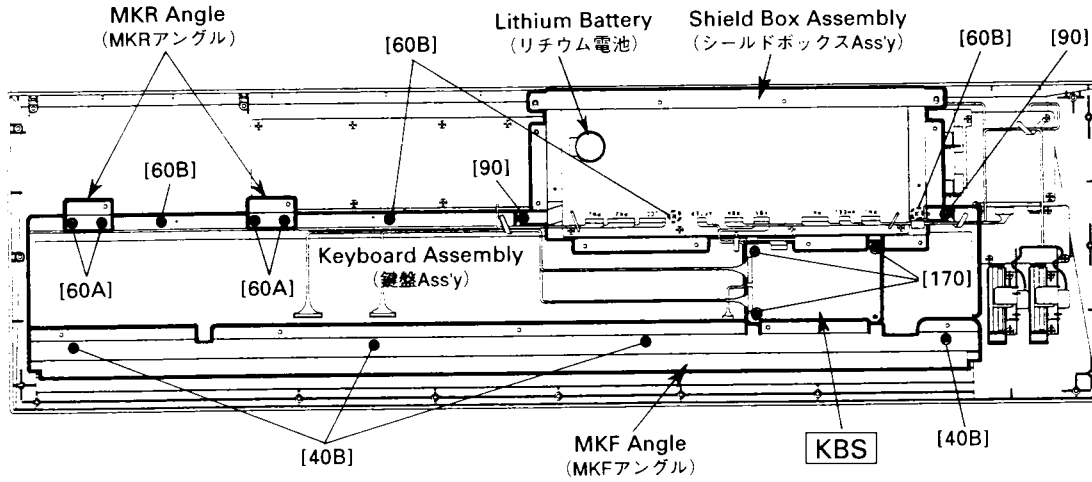

- [40B]: Bonding Tapping Screw-B 3.0X10 MFZN2BL (VQ049800) ボンディングBタイト
- [60A]: Bonding Tapping Screw-B 3.0X10 MFZN2BL (VQ049800) ボンディングBタイト
- [60B]: Bonding Tapping Screw-B 3.0X10 MFZN2BL (VQ049800) ボンディングBタイト
- [90]: Bonding Tapping Screw-B 3.0X10 MFZN2BL (VQ049800) ボンディングBタイト
- [170]: Bind Head Tapping Screw-B 3.0X8 MFZN2BL (EP600190) +バインドBタイト

(Fig. 2)

●Shield Box Assembly (シールドボックスAss'y)

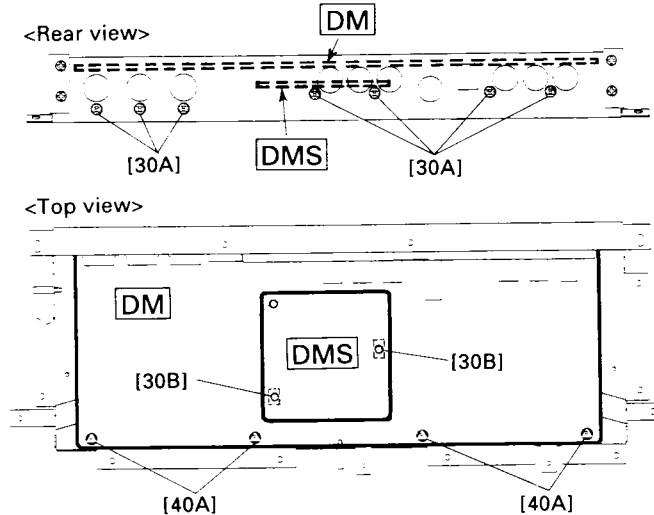

- [30A]: Bonding Tapping Screw-B 3.0X10 MFZN2BL (VQ049800) ボンディングBタイト
- [30B]: Support, PCB WLS-12-0 (VS261200) 基板サポート
- [40A]: Bonding Tapping Screw-B 3.0X10 MFZN2BL (VQ049800) ボンディングBタイト

(Fig. 3)

●When removing;  
(取外し時)

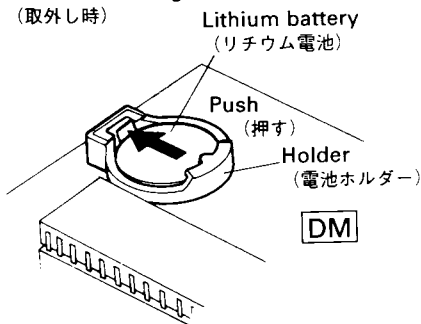

●When installing;  
(取外け時)

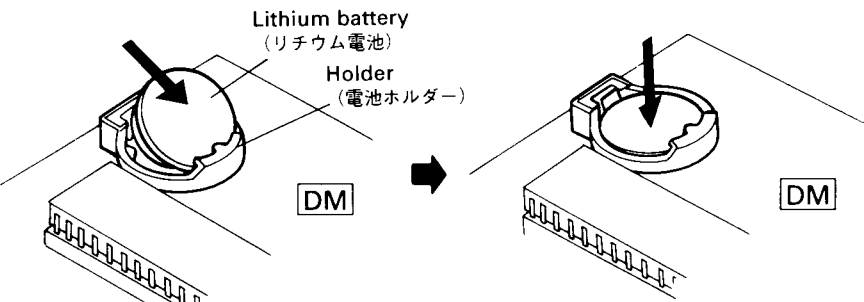

(Fig. 4)



#### 4. Keyboard Assembly

- 4-1 Remove the bottom assembly. (See Procedure 1.)
- 4-2 Remove the KBS circuit board. (See Procedure 2.)
- 4-3 Remove the shield box assembly. (See Procedure 3.)
- 4-4 Remove the four (4) screws marked [60A]. Then the two MKR angles can be removed. (Fig. 2)
- 4-5 Remove the four (4) screws marked [60B]. Then the keyboard assembly with the MKF angle can be removed. (Fig. 2)
- 4-6 Remove the four (4) screws marked [40B]. Then the MKF angle can be removed from the keyboard assembly. (Fig. 2)

#### 5. PN Circuit Boards (1/5~5/5)

- 5-1 Remove the bottom assembly. (See Procedure 1.)
- 5-2 Remove the KBS circuit board. (See Procedure 2.)
- 5-3 Remove the shield box assembly. (See Procedure 3.)
- 5-4 Jump to the procedure of the required circuit board.

##### 5-4-1 PN 1/5 Circuit Board

- 5-4-1-1 Remove the VOLUME knob from the top panel.
- 5-4-1-2 Remove the PN 2/5 circuit board and the PN 3/5 circuit board with the PN angle. (See Procedure 5-4-2)
- 5-4-1-3 Remove the two (2) screws marked [180A]. Then the PN 1/5 circuit board can be removed. (Fig. 5)

##### 5-4-2 PN 2/5 Circuit Board and PN 3/5 Circuit Board

- 5-4-2-1 Remove the eight (8) ASSIGN 1-8 knobs from the top panel.
- 5-4-2-2 Remove the four (4) screws marked [180B]. Then the PN 2/5 circuit board and the PN 3/5 circuit board with the PN angle can be removed. (Fig. 5)
- 5-4-2-3 Remove the each four (4) hexagonal nuts marked [A] and [B]. Then the PN 2/5 circuit board and the PN 3/5 circuit board can be removed from the PN angle. (Fig. 6)

##### 5-4-3 PN 4/5 Circuit Board

- 5-4-3-1 Remove the PN 2/5 circuit board and the PN 3/5 circuit board with the PN angle. (See Procedure 5-4-2)
- 5-4-3-2 Remove the two (2) screws marked [180C]. Then the PN 4/5 circuit board can be removed. (Fig. 5)

※ The LE1/2 circuit board is mounted on the PN4/5 circuit board.

##### 5-4-4 PN 5/5 Circuit Board

- 5-4-4-1 Remove the knob for dial from the top panel.
- 5-4-4-2 Remove the ten (10) screws marked [180D]. Then the PN 5/5 circuit board can be removed. (Fig. 5)

※ The LE2/2 circuit board is mounted on the PN5/5 circuit board.

#### 4. 鍵盤 Ass'y

- 4-1 ボトム Ass'y を外します。(1項参照)
- 4-2 KBS シートを外します。(2項参照)
- 4-3 シールドボックス Ass'y を外します。(3項参照)
- 4-4 [60A]のネジ4本を外して、MKR アングル2個を取り外します。(図2)
- 4-5 [60B]のネジ4本を外して、MKF アングルの付いた鍵盤 Ass'y を取り外します。(図2)
- 4-6 [40B]のネジ4本を外して、鍵盤 Ass'y に付いたMKF アングルを取り外します。(図2)

#### 5. PN シート (1/5~5/5)

- 5-1 ボトム Ass'y を外します。(1項参照)
- 5-2 KBS シートを外します。(2項参照)
- 5-3 シールドボックス Ass'y を外します。(3項参照)
- 5-4 取り外したいシートの手順へと進みます。

##### 5-4-1 PN 1/5 シート

- 5-4-1-1 本体のパネル面から VOLUME ツマミを抜いておきます。
- 5-4-1-2 PN アングルと共に PN 2/5 シートと PN 3/5 シートを外します。(5-4-2項参照)
- 5-4-1-3 [180A]のネジ2本を外し、PN 1/5 シートを取り外します。(図5)

##### 5-4-2 PN 2/5 シートと PN 3/5 シート

- 5-4-2-1 本体のパネル面から、ASSIGN1-8 のツマミ8個を抜いておきます。
- 5-4-2-2 [180B]のネジ4本を外し、PN アングルと共に、PN 2/5 シートと PN 3/5 シートを外します。(図5)
- 5-4-2-3 [A]、[B]の六角ナットをそれぞれ4個ずつ外して、PN 2/5 シートと PN 3/5 シートを PN アングルから取り外します。(図6)

##### 5-4-3 PN 4/5 シート

- 5-4-3-1 PN アングルと共に PN 2/5 シートと PN 3/5 シートを外します。(5-4-2項参照)
  - 5-4-3-2 [180C]のネジ2本を外し、PN 4/5 シートを取り外します。(図5)
- ※ PN4/5 シートには、LE1/2 シートが取り付けられています。

##### 5-4-4 PN 5/5 シート

- 5-4-4-1 本体のパネル面からダイヤル用のツマミ1個を抜いておきます。
  - 5-4-4-2 [180D]のネジ10本を外し、PN 5/5 シートを取り外します。(図5)
- ※ PN5/5 シートには、LE2/2 シートが取り付けられています。

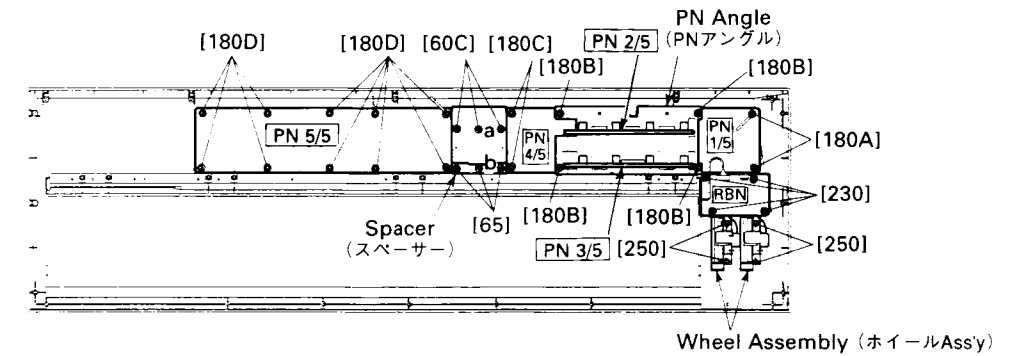

- |   |                   |            |
|---|-------------------|------------|
| [60C]: Bind Head Tapping Screw-P 3.0X8  | MFZN2Y (EP600280) | + バインドPタイト |
| [65]: Bind Head Tapping Screw-P 3.0X10  | MFZN2Y (EP630660) | + バインドPタイト |
| [180A]: Bind Head Tapping Screw-P 3.0X8 | MFZN2Y (EP600280) | + バインドPタイト |
| [180B]: Bind Head Tapping Screw-P 3.0X8 | MFZN2Y (EP600280) | + バインドPタイト |
| [180C]: Bind Head Tapping Screw-P 3.0X8 | MFZN2Y (EP600280) | + バインドPタイト |
| [180D]: Bind Head Tapping Screw-P 3.0X8 | MFZN2Y (EP600280) | + バインドPタイト |
| [230]: Bind Head Tapping Screw-P 3.0X8  | MFZN2Y (EP600280) | + バインドPタイト |
| [250]: Bind Head Tapping Screw-P 3.0X8  | MFZN2Y (EP600280) | + バインドPタイト |

(Fig. 5)

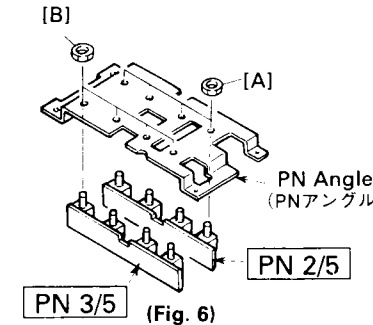

(Fig. 6)

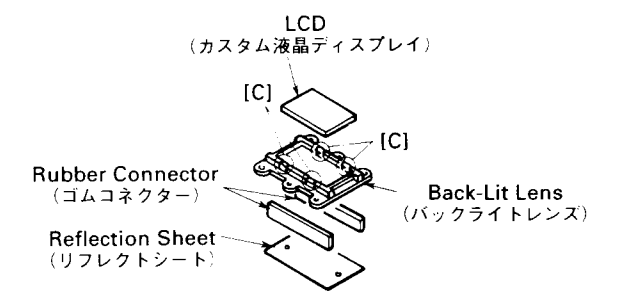

(Fig. 7)

#### 6. LC Circuit Board & LCD

- 6-1 Remove the bottom assembly. (See Procedure 1.)
  - 6-2 Remove the KBS circuit board. (See Procedure 2.)
  - 6-3 Remove the shield box assembly. (See Procedure 3.)
  - 6-4 Remove each of the three (3) screws marked [60C] and [65]. Then the spacer and the LC circuit board (Fig. 5)
- ※ When you re-install the LC circuit board, you should tighten the screws marked [60C] and [65] in the order of a, b shown in the figure. (Fig. 5)
- 6-5 After the LC circuit board has been removed, the reflection sheet can be removed. After that, remove the back-lit lens with the rubber connectors and LCD.
  - 6-6 While pushing the hooks marked [C], take the LCD out of the back-lit lens. (Fig. 7)
- ※ When you re-install the LCD, put the projection side at the opening of the upper case rib.

#### 6. LC シートとカスタム液晶ディスプレイ

- 6-1 ボトム Ass'y を外します。(1項参照)
  - 6-2 KBS シートを外します。(2項参照)
  - 6-3 シールドボックス Ass'y を外します。(3項参照)
  - 6-4 [60C]と[65]のネジ各3本を外して、スペーサーとLCシートを取り外します。(図5)
- ※ LCシートを取り付ける場合、図中のa、bの順に[60C]と[65]のネジで取り付けます。(図5)
- 6-5 LCシートを外した後リフレクトシートを外し、ゴムコネクタとカスタム液晶ディスプレイと共にバックライトレンズを外します。(図7)
  - 6-6 バックライトレンズの[C]のツメを外側に開いて、カスタム液晶ディスプレイを取り外します。
- ※ カスタム液晶ディスプレイを取り付ける際には、取り付け方向に注意して下さい。(凸部をスリット側に合わせます)

#### 7. RBN Circuit Board

- 7-1 Remove the bottom assembly. (See Procedure 1.)
- 7-2 Remove the four (4) screws marked [230]. Then the RBN circuit board with the ribbon sensor can be removed. (Fig. 5)
- 7-3 By pulling the ribbon sensor, it can be removed from the connector CN2 of the RBN circuit board.

#### 7. RBN シート

- 7-1 ボトム Ass'y を外します。(1項参照)
- 7-2 [230]のネジ4本を外して、リボンセンサー付きのRBNシートを取り外します。(図5)
- 7-3 RBNシートに付いたリボンセンサーをコネクタ CN2 から引き抜きます。

#### 8. Wheel Assembly

- 8-1 Remove the bottom assembly. (See Procedure 1.)
- 8-2 Remove the four (4) screws marked [250]. Then the wheel assembly can be removed. (Fig. 5)

#### 8. ホイール Ass'y

- 8-1 ボトム Ass'y を外します。(1項参照)
- 8-2 [250]のネジ4本を外して、ホイール Ass'y を取り外します。(図5)

■ LSI PIN DESCRIPTION (LSI端子機能表)

● HD6413002FP16 (XQ375A00) CPU <H8/3002>

PIN NO.	NAME	I/O	FUNCTION	PIN NO.	NAME	I/O	FUNCTION
1	A21	O	Address bus	51	A12	O	Address bus
2	A20	O		52	A13	O	
3	VCC	O		53	A14	O	
4	PB0	I/O	Power supply	54	A15	O	Address bus
5	PB1	I/O		55	A16	O	
6	PB2	I/O		56	A17	O	
7	PB3	I/O	Port B	57	A18	O	Address bus
8	PB4	I/O		58	A19	O	
9	PB5	I/O		59	VSS	O	
10	PB6	I/O	60	/WAIT	I	Bus cycle wait	
11	PB7	I/O	61	P61	I/O	Port 6	
12	/RESO	I	62	P62	I/O		
13	VSS	O	63	φ	O		Not connected
14	TXD0	O	64	/STBY	I	Stand-by mode signal	
15	P91	I/O	65	/RES	I	Reset	
16	RXD0	I	66	NMI	I	Non-maskable interrupt	
17	RXD1	I	67	VSS	O	Ground	
18	P94	I/O	68	EXTAL	I		Clock
19	SCK1	O	69	XTAL	O		
20	P40	I/O	70	VCC	O	Power supply	
21	P41	I/O	71	/AS	O		Address strobe
22	P42	I/O	72	/RD	O		Read strobe
23	P43	I/O	73	/HWR	O	Write strobe (High)	
24	VSS	O	(Ground)	74	/LWR	O	Write strobe (Low)
25	P44	I/O		75	MD0	I	Mode select
26	P45	I/O		76	MD1	I	
27	P46	I/O	77	MD2	I		
28	P47	I/O	78	AVCC	I	Analog power supply	
29	D08	I/O	79	VREF	I	Reference voltage	
30	D09	I/O	80	AN0	I	Analog data input (Power)	
31	D10	I/O	81	AN1	I	Analog data input (SUSTAIN)	
32	D11	I/O	82	P72	I/O	Port 7	
33	D12	I/O	83	P73	I/O		
34	D13	I/O	84	P74	I/O		
35	D14	I/O	85	P75	I/O	Power supply	
36	D15	I/O	86	P76	I/O		
37	VCC	O	87	P77	I/O		
38	A00	O	88	AVSS	O	Analog ground	
39	A01	O	89	P80	I/O	Port 8	
40	A02	O	90	/CS3	I		
41	A03	O	91	/CS2	I		Chip select
42	A04	O	92	/CS1	I		
43	A05	O	93	/CS0	I		
44	A06	O	94	VSS	O	Ground	
45	A07	O	95	PA0	I/O		Port A
46	VSS	O	96	PA1	I/O		
47	A08	O	97	PA2	I/O		
48	A09	O	98	PA3	I/O	Address bus	
49	A10	O	99	A23	O		
50	A11	O	100	A22	O		

● YSS236-F (XT013A00) VOP3

PIN NO.	NAME	I/O	FUNCTION	PIN NO.	NAME	I/O	FUNCTION	
1	VSS	O	Power supply	81	SO7	O	Serial output	
2	WA17	O		82	SO6	O		
3	WA16	O		83	SO5	O		
4	WA15	O	External memory address bus	84	VDD	O	Ground Power supply	
5	WA14	O		85	VSS	O		
6	WA13	O		86	SO4	O		
7	WA12	O	Ground	87	SO3	O	Serial output	
8	WA11	O		88	SO2	O		
9	WA10	O		89	SO1	O		
10	VDD	O	Power supply	90	SO0	O		
11	VSS	O		91	WDCK	O	Data enable for DAC	
12	WA09	O		92	SWPKON	O	SWP00 format key on output	
13	WA08	O	Ground	93	IRQN	O	EG interrupt	
14	WA07	O		94	VDD	O	Ground Power supply	
15	WA06	O		95	VSS	O		
16	WA05	O	External memory address bus	96	XTAL_I	I		Quartz crystal terminal
17	WA04	O		97	XTAL_O	O	Quartz crystal terminal	
18	WA03	O		98	MCLK	O	Oscillate clock output	
19	WA02	O	Ground	99	VDD	O	Ground Power supply	
20	VDD	O		100	VSS	O		
21	VSS	O		101	MICN	I		Initial clear
22	WA01	O	External memory address bus	102	CLKIN	I	Master clock input	
23	WA00	O		103	SYWIN	I	Sync.signal input	
24	WEN	O		104	SYW	O	Sync.signal output	
25	OEN	O	External memory control (OEN)	105	SYWD	O	Sync.signal output	
26	RASN	O		106	VDD	O	Ground Power supply	
27	CASN	O		107	VSS	O		
28	CEN	O	External memory control (CEN)	108	CLKO	O		For test (512 fs output)
29	VDD	O		109	WCLK	O	2 times sync.clock output (256fs)	
30	VSS	O		110	HCLK	O	4 times sync.clock output (128fs)	
31	WD19	I/O	Ground	111	QCLK	O	8 times sync.clock output (64fs)	
32	WD18	I/O		112	TSTCI	I	PLL test input	
33	WD17	I/O		External memory data bus	113	VDD	O	Ground Power supply
34	WD16	I/O	114		VSS	O		
35	WD15	I/O	115		(NC)	O		
36	WD14	I/O	Ground	116	VDD(PLL)	O	PLL control output	
37	VDD	O		117	CPO	O		PLL control input
38	VSS	O		118	CPIN	I		PLL control input
39	WD13	I/O	Power supply	119	REF	I	PLL control input	
40	WD12	I/O		120	VSS(PLL)	O		
41	WD11	I/O		External memory data bus	121	(NC)	O	Ground Power supply
42	WD10	I/O	122		VDD	O	Power supply PLL test input	
43	WD09	I/O	123		VSS	O		
44	WD08	I/O	Ground	124	TSTCS	I		CPU address bus
45	WD07	I/O		125	CA6	I		
46	VDD	O		126	CA5	I		
47	VSS	O	Power supply	127	CA4	I	CPU address bus	
48	WD06	I/O		128	CA3	I		
49	WD05	I/O		129	CA2	I		
50	WD04	I/O	External memory data bus	130	VDD	O	Ground Power supply	
51	WD03	I/O		131	VSS	O		
52	WD02	I/O		132	CA1	I		CPU address bus
53	WD01	I/O	Ground	133	CA0	I	Lo/Hi select in 8 bits write	
54	WD00	I/O		134	CSN	I		Chip select
55	VDD	O		135	RDN	I		Register read
56	VSS	O	Power supply	136	WRN	I	Register write	
57	TST2	O		137	BTYP	I	Data bus type select	
58	TST1	O		Test output	138	VDD	O	Ground Power supply
59	TST0	O	139		VSS	O		
60	MS	I	Memory select		140	CD15	I/O	
61	LRCLK	O		141	CD14	I/O		
62	SI7	I		142	CD13	I/O		
63	SI6	I	Serial input	143	CD12	I/O		
64	VDD	O		144	CD11	I/O		
65	VSS	O		Ground	145	VDD	O	Ground Power supply
66	SI5	I	146		VSS	O		
67	SI4	I	Serial input		147	CD10	I/O	
68	SI3	I		148	CD09	I/O		
69	SI2	I		149	CD08	I/O		
70	SI1	I	Ground	150	CD07	I/O	CPU data bus	
71	SI0	I		151	CD06	I/O		
72	DB1	I		152	CD05	I/O		
73	DB0	I	Output bit type select for DAC	153	VDD	O	Ground Power supply	
74	VDD	O		154	VSS	O		
75	VSS	O		155	CD04	I/O		
76	ODFM	I	Output mode select for DAC	156	CD03	I/O	CPU data bus	
77	OFS3	I		157	CD02	I/O		
78	OFS2	I		Serial output format select	158	CD01		I/O
79	OFS1	I	159		CD00	I/O		
80	OFS0	I	160		VDD	O	Ground	

● HD63B05V0E65F (XN668A00) PKS

PIN NO.	NAME	I/O	FUNCTION	PIN NO.	NAME	I/O	FUNCTION
1	C7	O	Block signal B08	28	RES	I	Reset
2	C6	O	Block signal B07	29	INT	I	Interrupt
3	C5	O	Block signal B06	30	NUM	I	Grounding
4	C4	O	Block signal B05	31	NC		Not used.
5	NC		Not used.	32	A7	I	Grounding
6	NC		Not used.	33	A6	I	Grounding
7	C3	O	Block signal B04	34	NC		Not used.
8	C2	O	Block signal B03	35	A5	I	Note data N15
9	C1	O	Block signal B02	36	A4	I	Note data N14
10	C0		Not used.	37	NC		Not used.
11	NC		Not used.	38	A3	I	Note data N13
12	NC		Not used.	39	A2	I	Note data N12
13	D0	O	Block signal B09	40	A1	I	Note data N11
14	D1	O	Block signal B10	41	A0	I	Note data N10
15	D2	O	Block signal B11	42	NC		Not used
16	D3/TX	O	Send signal to CPU	43	NC		Not used
17	NC		Not used.	44	B0	I	Note data N00
18	D4/RX	O	Block signal B12	45	B1	I	Note data N01
19	D5//CK	I	Clock	46	B2	I	Note data N02
20	D6//INT2	I	Not used	47	B3	I	Note data N03
21	NC		Not used.	48	NC		Not used.
22	/STBY	I	Stand by +5V	49	B4	I	Note data N04
23	TIMER	I	+ 5V	50	B5	I	Note data N05
24	XTAL		} Clock 8MHz	51	B6	I	Grounding
25	EXTAL			52	B7	I	Grounding
26	Vcc		Power Supply +5V	53	NC		Not used.
27	SUB	I	Grounding	54	Vss		Ground

●  $\mu$ PD63200GS-E1 (XP867A00) DAC (Digital to Analog Converter)

PIN NO.	NAME	I/O	FUNCTION	PIN NO.	NAME	I/O	FUNCTION
1	4/8F	I	4/8 Fs selection	9	R. REF		Channel R voltage reference
2	D. GND		Digital ground	10	L. REF		Channel L voltage reference
3	16 BIT	I	16 bit/18 bit selection	11	L. OUT	O	Channel L output
4	D. VDD		Digital power supply	12	A. GND		Analog ground
5	A. GND		Analog ground	13	WDCK	I	Word clock
6	R. OUT	O	Channel R output	14	RSI	I	Channel R series input
7	A. VDD		} Analog power supply	15	SI/LSI	I	Series input/Channel L series input
8	A. VDD			16	CLK	I	Clock

• HD62098 (XM309A00) MEG (Multiple Effect Generator)

PIN NO.	NAME	I/O	FUNCTION	PIN NO.	NAME	I/O	FUNCTION
1	GND		Ground	41	GND4		Ground
2	MD8	I/O	DRAM data bus	42	SYW	O	Synch. signal for 256fs system
3	MD9	I/O		43	SYW0D	O	Synch. signal for 128/64 fs system
4	MD10	I/O		44	QCLK	O	1/4 clock
5	MD11	I/O		45	HCLK	O	1/2 clock
6	MD12	I/O		46	/CS	I	Chip enable
7	MD13	I/O		47	/RD	I	Read enable
8	MD14	I/O		48	/WR	I	Write enable
9	MD15	I/O		49	A0	I	CPU address bus
10	MD0	I/O		50	A1	I	
11	MD1	I/O		51	A2	I	
12	MD2	I/O		52	A3	I	
13	MD3	I/O		53	A4	I	
14	MD4	I/O		54	D0	I/O	CPU data bus
15	MD5	I/O		55	D1	I/O	
16	MD6	I/O		56	D2	I/O	
17	MD7	I/O	57	D3	I/O		
18	/WE	O	58	D4	I/O		
19	/RASH	O	59	D5	I/O		
20	/RASL	O	60	D6	I/O		
21	Vcc1		61	D7	I/O	Test pin	
22	GND2		62	TEST	I		Initial clear
23	MA0	O	63	/IC	I		Power supply
24	MA1	O	DRAM address bus	64	Vcc4		Ground
25	MA2	O		65	GND5		MEL formatted signal inout
26	MA3	O		66	IMEL0	I	
27	MA4	O		67	IMEL1	I	
28	MA5	O		68	IMEL2	I	MEL cascade input
29	MA6	O		69	IMEL3	I	
30	MA7	O		70	AUXMEL0	I	MEL formatted signal output
31	/CASH	O	71	AUXMEL1	I		
32	/CASL	O	72	OMEL0	O	L channel signal output	
33	Vcc2		73	OMEL1	O		R channel signal output
34	EXTAL	I	connected to quartz crystal	74	DAC0L	O	L channel signal output
35	XTAL	O	connected to quartz crystal	75	DAC0R	O	R channle signal output
36	GND3		Ground	76	DAC1L	O	L channel signal output
37	MCLK	O	Master clock output	77	DAC1R	O	R channle signal output
38	CLKIN	I	Master cloack input	78	WDCX	O	Load signal for DAC
39	SYWIN	I	Synch. signal input	79	PAD18/20	I	18-bit/20-bit select
40	Vcc3		Power supply	80	Vcc5		Power supply

■ IC BLOCK DIAGRAM (ICブロック図)

- **TC74HC14AF-TP1 (XD657A00)** Hex Inverter
- **TC74AC139F (XP231A00)** Dual 2 to 4 Demultiplexer

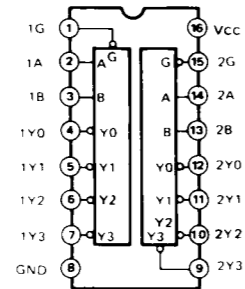
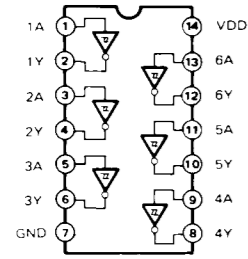

- **TC74HC4053AF (XR150A00)** Triple 2-Ch. Multiplexer/Demultiplexer

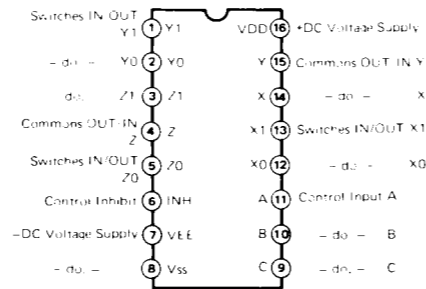

- **TC74HC238AF (XT163A00)** 3 to 8 Line Decoder

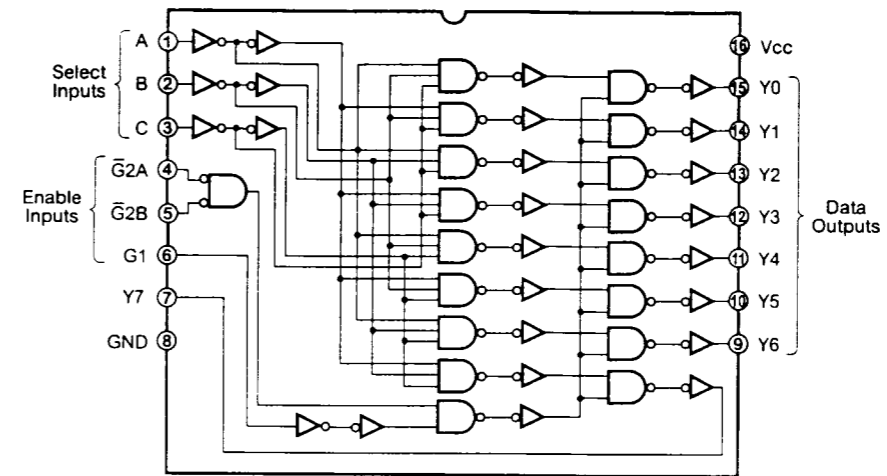

- **SN74HC245NSR (XD838A00)** Octal 3-State Bus Transceiver
- **NJM4556AMT1 (XQ138A00)** Dual Operational Amplifier
- **RC4558D-V (IG001390)** Dual Operational Amplifier
- **μPC4570G2 (XF291A00)** Dual Operational Amplifier
- **TC7S32F (XM588A00)** OR

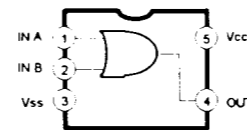
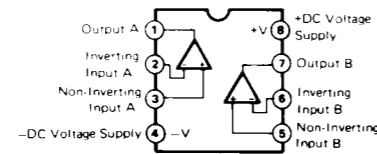
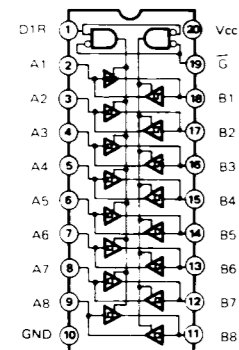

- **TC74HC595AF (XR011A00)** Shift Register

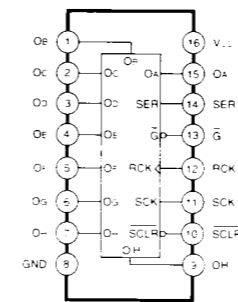

## TEST PROGRAM

number	TEST	TEST RESULTS
T1	RAM READ/WRITE	OK/NG
T2	BATTERY	OK/NG
T3	LCD	ALL DOTS ON/OFF
T4	PANEL SWITCH/LED	OK, ON/OFF
T5	KEYBOARD	OK, KEY CODE/KEY TOUCH
T6	MIDI IN/OUT/THRU	OK/NG
T7	1k Hz SOUND OUTPUT (OUTPUT L)	OUTPUT L: +4.0 ±2 dBm (10k Ω load)
		OUTPUT R: less than -72.0 dBm (10k Ω load)
		PHONES (L): -2.9 ±2 dBm (33 Ω load)
		PHONES (R): less than -72.0 dBm (33 Ω load)
T8	1k Hz SOUND OUTPUT (OUTPUT R)	OUTPUT R: +4.0 ±2 dBm (10k Ω load)
		OUTPUT L: less than -72.0 dBm (10k Ω load)
		PHONES (R): -2.9 ±2 dBm (33 Ω load)
		PHONES (L): less than -72.0 dBm (33 Ω load)
T9	EQ SOUND OUTPUT (LOW)	
T10	EQ SOUND OUTPUT (HIGH)	
T11	FX DRAM	
T12	8CH OUT	
T13	KNOB1	OK, 0-10-120-127-120-10-0
T14	KNOB2	OK, 0-10-120-127-120-10-0
T15	KNOB3	OK, 0-10-120-127-120-10-0
T16	KNOB4	OK, 0-10-120-127-120-10-0
T17	KNOB5	OK, 0-10-120-127-120-10-0
T18	KNOB6	OK, 0-10-120-127-120-10-0
T19	KNOB7	OK, 0-10-120-127-120-10-0
T20	KNOB8	OK, 0-10-120-127-120-10-0
T21	PITCH BEND	OK, 64-0-127-0-64
T22	MODULATION WHEEL	OK, 0-10-120-127-120-10-0
T23	RIBBON X	OK, 0-10-120-127-120-10-0-128
T24	RIBBON Z	OK, 00-02-09-120-127-120-09-00-02
T25	AFTER TOUCH	OK, 00-02-09-120-127-120-09-00-02
T26	FOOT VOLUME	OK, 0-10-120-127-120-10-0
T27	FOOT CONTROLLER(QS)	OK, 0-10-120-127-120-10-0
T28	FOOT SWITCH	OK, 0-1-0
T29	FACTORY SET	OK
T30	EXIT(NOISE LEVEL)	OUTPUT(L,R): less than -83.0 dBm (10k Ω load)
		PHONES(L,R): less than -90.0 dBm (33 Ω load)

Measuring instruments listed below are required to perform the tests:  
frequency counter, oscilloscope and AC voltmeter (with JIS-C filter and flat filter), keyboard amplifier

### A. HOW TO ENTER THE TEST PROGRAM

Turn on the AN1x power switch while pressing the [0], the [-] and the [+] switches simultaneously. The AN1X will indicate that it has entered the test program by displaying the following message.

```
Test Mode
##. ##
```

After a while the following display will appear.

```
01:RAM
```

Use the PROGRAM[+] and the PROGRAM[-] switches to select the test number.

### B. PROCEEDING THROUGH THE TESTS

When entering the test program, the following display will appear.

```
01:RAM
```

Use the PROGRAM[+] and the PROGRAM[-] switches to move through the various tests of the test program and the [STORE] switch for the selected test to be executed.

PROGRAM[+] will select the test which follows the current test.

PROGRAM[-] will select the test which precedes the current test.

[STORE] will execute the currently selected test. If the test result is OK, the next test will be selected and executed automatically and proceed sequentially.

[PORTAMENTO] will cancel the execution of the test while executing the test and the AN1x will be back to the status before the execution.

### C. TEST SELECTION WHEN AN ERROR IS DETECTED

In each of the test, if an NG (No Good) error is detected, pressing the [PORTAMENTO] will make the AN1x wait for the entry of the test number. You can then retry the test or perform another test.

### D. INITIALIZING

Turn on the power switch of the AN1x while pressing the [7], [8] and the [9] switches. The AN1x will initialize the memorized data.

### T1. RAM READ/WRITE TEST

```
01:RAM
```

Perform a read/write/verify test of RAM.

#### DISPLAY OF THE RESULTS

```
OK 01:RAM
    OK
```

```
NG 01:RAM
    NG
```

#### TEST END

This test ends after displaying the result. All RAM data is preserved.

### T2. RAM BACKUP BATTERY TEST

```
02:BATTERY
```

This test checks if the voltage of the RAM backup battery is greater than 2.8 V and less than 3.6 V.

#### DISPLAY OF THE RESULTS

```
OK 02:BATTERY
    OK
```

```
NG 02:BATTERY
    NG
```

#### TEST END

This test ends after displaying the result.

### T3. LCD TEST

Check that all dots of the LCD blink ON/OFF.

#### TEST END

Press the [STORE] switch to end this test and the test will proceed to the next test.

### T4. PANEL SWITCH/LED TEST

```
04:Sw&LED
Scen2
```

Press the panel switches consecutively from the [SCENE2] switch to the [Rotary6] switch, according to the order indicated by the LCD.

04; Sw&LED Scen2
---------------------

(e.g. The next check [SCENE2] is ready.)

When the next check is ready, the LCD indicates the next check switch. If there is a corresponding LED, it blinks. When the check switch is pressed and the result of the check is good, a beep will sound and the blinking LED will go out, if applicable. Then the next check is ready and the LCD will indicate the switch. If a switch that the LCD is not indicating is pressed, the check will be ignored and the status will not change. When all the switch checks have finished and all the results have been good, the LCD will indicate "OK".

#### DISPLAY OF THE RESULTS

OK	04; Sw&LED OK
----	------------------

NG (No change in display message)

#### TEST END

After displaying "OK" of the test result above, the test will end and proceed to the next test.

#### T5. KEYBOARD TEST

05; KBD C1
---------------

Play a scale on the keyboard from C1 to C6.

05; KBD G#3
----------------

(e.g. The next check key switch is G#3)

If the key switch is good, the note will sound and the LCD will indicate the next key switch number. If the wrong key is played, the sound of that note will not be heard and the check will be ignored. However if the right key is played following the playing of the wrong key, the note of that key will sound. Proceed to play the next key. If all key switches are good, "OK" will be displayed on the LCD.

#### DISPLAY OF THE RESULTS

OK	05; KBD OK
----	---------------

NG (No change in display message)

#### TEST END

After displaying "OK" of the test result, the test will end and proceed to the next test.

#### T6. MIDI

06; MIDI
----------

After connecting the MIDI IN to the MIDI OUT via a MIDI cable, execute the test. If the MIDI IN/OUT check is good, "OK" will be displayed on the LCD and the test pattern MIDI code (AA FF 00 55) will be transmitted from the MIDI THRU.

#### DISPLAY OF THE RESULTS

OK	06; MIDI OK
----	----------------

NG	06; MIDI NG
----	----------------

#### TEST END

When the test result is displayed on the LCD, the test will end. If the test result is "OK", the test will proceed to the next test.

#### T7. 1k Hz SOUND OUTPUT (OUTPUT L) TEST

07; OUTL 1k
-------------

Check that the correct signal is output from OUTPUT L and PHONES (L) jacks.

Insert the appropriate phone plugs into each output jack OUTPUT L, OUTPUT R, and PHONES(L/R) outputs. If necessary, verify the frequency, output waveform and output level of each output using a frequency counter, oscilloscope and AC voltmeter (with JIS-C filter). The VOLUME control must be set at maximum for these checks. Press the [STORE] switch to start the test, and the LCD will display the following message while sounding.

07; OUTL 1K Doing
----------------------

OUTPUT L: 1k Hz  $\pm$ 1.5 Hz, sine wave,

+4.0  $\pm$ 2 dBm (10k ohm load)

OUTPUT R: less than -72dBm (10k ohm load)

PHONES(L): 1k Hz  $\pm$ 1.5 Hz, sine wave,  
-2.9  $\pm$ 2 dBm (33 ohm load)

PHONES(R): less than -72dBm (33 ohm load)

#### TEST END

Press the [PORTAMENTO] or the PROGRAM[+] to end the test. After pressing [PORTAMENTO], the sound will stop and the AN1x will wait for the entry of a test number. If the [STORE] is pressed, the sound will stop and the test will proceed to the next test.

### T8. 1k Hz SOUND OUTPUT (OUTPUT R) TEST

08:OUTR 1k

Check that the correct signal is output from OUTPUT R and PHONES (R) jacks.

Insert the appropriate phone plugs into each output jack OUTPUT L, OUTPUT R, and PHONES(L/R) outputs. If necessary, verify the frequency, output waveform and output level of each output using a frequency counter, oscilloscope and AC voltmeter (with JIS-C filter). The VOLUME control must be set at maximum for these checks. Press the [STORE] switch to start the test, and the LCD will display the following message while sounding.

08:OUTR 1k  
Doing

OUTPUT L: less than -72dBm (10k ohm load)

OUTPUT R: 1k Hz  $\pm$ 1.5 Hz, sine wave,  
+4.0  $\pm$ 2 dBm (10k ohm load)

PHONES(L): less than -72dBm (33 ohm load)

PHONES(R): 1k Hz  $\pm$ 1.5 Hz, sine wave,  
-2.9  $\pm$ 2 dBm (33 ohm load)

#### TEST END

Press the [PORTAMENTO] or the PROGRAM[+] to end the test. After pressing [PORTAMENTO], the sound will stop and the AN1x will wait for the entry of a test number. If the [STORE] is pressed, the sound will stop and the test will proceed to the next test.

### T9. EQ SOUND OUTPUT (LOW) TEST

09:Low EQ

Check that the correct signal is output from each output jack.

If necessary, verify the output level of each output using an oscilloscope and AC voltmeter (with a flat filter). The VOLUME control must be set at maximum for these checks. Press the [STORE] switch to start the test, and the LCD will display the following message while sounding.

09:Low EQ  
Doing

Listed below are the specifications and conditions of each during this test.

OUTPUT L: +1.5  $\pm$ 1 dB with the level measured in the tset 7, "SOUND OUTPUT (OUTPUT L) TEST" as a reference

OUTPUT R: +1.5  $\pm$ 1 dB with the level measured in the tset 8, "SOUND OUTPUT (OUTPUT R) TEST" as a reference

#### TEST END

Press the [PORTAMENTO] or the PROGRAM[+] to end the test. After pressing [PORTAMENTO], the sound will stop and the AN1x will wait for the entry of a test number. If the [STORE] is pressed, the sound will stop and the test will proceed to the next test.

### T10. EQ SOUND OUTPUT (HIGH) TEST

10:High EQ

Check that the correct signal is output from each output jack.

If necessary, verify the output level of each output using an oscilloscope and AC voltmeter (with a flat filter). The VOLUME control must be set at maximum for these checks. Press the [STORE] switch to start the test, and the LCD will display the following message while sounding.

10:High EQ  
Doing

Listed next are the specifications and conditions of each during this test.

OUTPUT L: +1.5  $\pm$ 1 dB with the level measured in the tset 7, "SOUND OUTPUT (OUTPUT L) TEST" as a reference

OUTPUT R: +1.5  $\pm$ 1 dB with the level measured in the tset 8, "SOUND OUTPUT (OUTPUT R) TEST" as a reference



**TEST END**

Press the [PORTAMENTO] or the PROGRAM[+] to end the test. After pressing [PORTAMENTO], the sound will stop and the AN1x will wait for the entry of a test number. If the [STORE] is pressed, the sound will stop and the test will proceed to the next test.

**T11. EFFECT DRAM TEST**

11;FX DRAM

Check that the correct signal is output from the OUTPUT L jack.

If necessary, verify the output level of each output using an oscilloscope and AC voltmeter (with JIS-C filter). The VOLUME control must be set at maximum for these checks. The output should be measured at least two (2) seconds. Press the [STORE] switch to start the test, and the LCD will display the following message while sounding.

11;FX DRAM  
Doing

Listed below are the specifications and conditions of the output during this test.

OUTPUT L: 1k Hz  $\pm 3$  Hz, sine wave,  
+4.0  $\pm 2$  dBm (10k ohm load)

**TEST END**

Press the [PORTAMENTO] or the PROGRAM[+] to end the test. After pressing [PORTAMENTO], the sound will stop and the AN1x will wait for the entry of a test number. If the [STORE] is pressed, the sound will stop and the test will proceed to the next test.

**T12. 8 CHANNEL OUTPUT TEST**

12;8ch

Check that the correct signal is output.

If necessary, verify the output level of each output using an oscilloscope and AC voltmeter (with JIS-C filter). The VOLUME control must be set at maximum for these checks. Press the [STORE] switch to start the test, and the LCD will display the following message while sounding.

12;8ch  
xx yy

(where xx is currently output channel number from L channel and yy is from R channel)

Check that the correct signals of 1k Hz, sine wave output.

**TEST END**

Press the [PORTAMENTO] or the PROGRAM[+] to end the test. After pressing [PORTAMENTO], the sound will stop and the AN1x will wait for the entry of a test number. If the [STORE] is pressed, the sound will stop and the test will proceed to the next test.

**T13. KNOB 1 (ASSIGN 1)**

13;Kn1 xxx  
000

(where xxx = current KNOB 1 value)

According to the target value displayed on the LCD, rotate the KNOB 1 slowly.

Check that the value changes from 64 to 127 then 00 and back to 64 (in other words, center to top then to bottom and back to center).

13;Kn1 xxx  
yyy

(where xxx = current KNOB 1 value and yyy = next target value)

**DISPLAY OF THE RESULTS**

OK  
13;Kn1 xxx  
OK

NG (No change in display message)

**TEST END**

The test ends after displaying the result.

**T14. KNOB 2 (ASSIGN 2) TEST****T15. KNOB 3 (ASSIGN 3) TEST****T16. KNOB 4 (ASSIGN 4) TEST****T17. KNOB 5 (ASSIGN 5) TEST****T18. KNOB 6 (ASSIGN 6) TEST****T19. KNOB 7 (ASSIGN 7) TEST****T20. KNOB 8 (ASSIGN 8) TEST**

These tests can be performed in the same manner as the test 13, "KNOB 1 (ASSIGN 1) TEST".

**T21. PITCH BEND WHEEL TEST**

21;PB xxx 000
------------------

(where xxx = current PITCH bend value)

According to the target value displayed on the LCD, slowly rotate the PITCH bend wheel.  
Check that the value changes from 64 to 00 then 127 and back to 00 (in other words, from center to bottom then to top and back to bottom).

21;PB xxx yyy
------------------

(where xxx = current PITCH bend value and yyy = next target value)

**DISPLAY OF THE RESULTS**

OK 

21;PB xxx OK
-----------------

NG (No change in display message)

**TEST END**

The test ends after displaying the result.

**T22. MODULATION WHEEL TEST**

22;MW xxx 000
------------------

(where xxx = current MODULATION wheel value)

According to the target value displayed on the LCD, slowly rotate the MODULATION wheel.  
Check that the value changes from 00 to 127 and back to 00 (in other words, from bottom to top and back to bottom).

22;MW xxx yyy
------------------

(where xxx = current MODULATION wheel value and yyy = next target value)

**DISPLAY OF THE RESULTS**

OK 

22;MW xxx OK
-----------------

NG (No change in display message)

**TEST END**

The test ends after displaying the result.

**T23. RIBBON X TEST**

23;RbX xxx 000
-------------------

(where xxx = current RIBBON X value)

According to the target value displayed on the LCD, gently touch the RIBBON and slide a finger slowly along the RIBBON.

Check that value changes from 00 to 127 then back to 00 (in other words, from left to right then back to left on the RIBBON). Finally, when the target value has been 128 next to 00, release your touch from the RIBBON.

23;RbX xxx yyy
-------------------

(where xxx = current RIBBON X value and yyy = next target value)

**DISPLAY OF THE RESULTS**

OK 

23;RbX 128 OK
------------------

NG (No change in display message)

**TEST END**

The test ends after displaying the result.

**T24. RIBBON Z TEST**

24;RbZ 000 9-120
---------------------

According to the target value displayed on the LCD, gently press the center area of the RIBBON and press the RIBBON from gently to firmly then back to gently.

Check that the value changes from 00 to 127 then back to 00 (in other words, touch from softly to hard then back to softly to the RIBBON).

24;RbZ xxx yyy
-------------------

(where xxx = current RIBBON Z value and yyy = next target value)

**DISPLAY OF THE RESULTS**

OK 

24;RbZ 000 OK
------------------

NG (No change in display message)

TEST END  
The test ends after displaying the result.

**T24. AFTER TOUCH TEST**

25;AT 000 9-120
--------------------

According to the target value displayed on the LCD, play the key of the note number D3 gently and push it from gently to firmly then back to gently. Check that the value changes from 00 to 127 then back to 00 (in other words, play from softly to hard then back to softly ).

25;AT xxx yyy
------------------

(where xxx = current AFTER TOUCH value and yyy = next target value)

**DISPLAY OF THE RESULTS**

OK 

25;AT xxx OK
-----------------

NG (No change in display message)

TEST END  
The test ends after displaying the result.

**T26. FOOT VOLUME**

26;FV xxx 000
------------------

(where xxx = current FOOT VOLUME value)

According to the target value displayed on the LCD, gently press the FOOT VOLUME pedal. Check that value changes from 00 to 127 then back to 00 (in other words, from the raised position to the lowered position then back to the raised position).

26;FV xxx yyy
------------------

(where xxx = current FOOT VOLUME value and yyy = next target value)

**DISPLAY OF THE RESULTS**

OK 

26;FV xxx OK
-----------------

NG (No change in display message)

TEST END  
The test ends after displaying the result.

**T27. FOOT CONTROLLER**

27;FC xxx 000
------------------

(where xxx = current FOOT CONTROLLER value)

According to the target value displayed on the LCD, gently press the FOOT CONTROLLER pedal. Check that value changes from 00 to 127 then back to 00 (in other words, from the raised position to the lowered position then back to the raised position).

27;FC xxx yyy
------------------

(where xxx = current FOOT CONTROLLER value and yyy = next target value)

**DISPLAY OF THE RESULTS**

OK 

27;FC xxx OK
-----------------

NG (No change in display message)

TEST END  
The test ends after displaying the result.

**T28. FOOT SWITCH**

28;FS off ON
-----------------

Connect a FOOT SWITCH and press down and lift. Check that the indication on the LCD changes from off to ON then back to off and verify that the "OK" result is displayed.

28;FS xxx yyy
------------------

(where xxx = current FOOT SWITCH value and yyy = next target value)

**DISPLAY OF THE RESULTS**

OK 

28;FS off OK
-----------------

NG (No change in display message)

TEST END  
The test ends after displaying the result.

**T29. FACTORY SETTINGS**

29;FACTSET

This test is used to initialize the data to the factory settings.

If you press the [STORE], the factory preset data will be restored and the test will end.

After the factory preset data has been restored, the system data will be as the list at right.

**T30. EXIT TEST PROGRAM**

30;EXIT

To exit the test program mode, press the [STORE] switch. Then the LCD will request the confirmation for exiting the test mode as follows.

30;EXIT  
Sure?

When pressing the [STORE] switch, the AN1x will exit the test program mode. If the cancellation is required, press the [PORTAMENT]. Then the AN1x will be at the test selected before the confirmation.

After exiting the test program mode, measure the noise level of each output without turning on any key of the keyboard. While measuring the noise level, use an AC voltmeter (with JIS-C filter).

- OUTPUT L: less than -83 dBm (10k ohm load)
- OUTPUT R: less than -83 dBm (10k ohm load)
- PHONES L: less than -90 dBm (33 ohm load)
- PHONES R: less than -90 dBm (33 ohm load)

(Factory setting data)

**SYSTEM SETUP**

System Setup	Data
Master Tune	+0(cent)
Master Volume	127
Keyboard Transpose	+0
Keyboard Velocity Curve	wide
Keyboard Fix Velocity	off
Midi Keyboard Transmit Channel	01
Midi Arp/SEQ Transmit Channel	off
Midi Receive Channel 1	01
Midi Receive Channel 2	01
Midi Device Number	all
Midi Local	on
MW Control Number	01
FC Control Number	04
FV Control Number	07
Ribbon X Control Number	13
Ribbon Y Control Number	12
Data Knob1 Control Number	41
Data Knob2 Control Number	42
Data Knob3 Control Number	43
Data Knob4 Control Number	44
Data Knob5 Control Number	45
Data Knob6 Control Number	46
Data Knob7 Control Number	47
Data Knob8 Control Number	48
Foot Switch Control Number	64
Scene Controller Number	01

**USER VOICE**

The 128 user voice data of the factory preset data will be restored.

**USER PATTERN**

The 128 user pattern data of the factory preset data will be restored.

**FACTORY PRESET MODE & VOICE NUMBER**

Voice Number is User Voice 1

You should set the voice number to 1, after setting sound control knobs at the positions listed as below.

Data Knob 1-8	most clockwise
Edit Rotary Select Knob	most top
Volume Knob	minimum
Pitch Bend Wheel	center
Modulation Wheel	minimum

## ■ テストプログラム

テスト番号	テスト	判定条件など
T1	RAM READ/WRITE	OK/NG
T2	BATTERY	OK/NG
T3	LCD	全ドット黒/白
T4	PANEL SWITCH/LED	OK,ON/OFF
T5	KEYBOARD	OK,KEY CODE/KEY TOUCH
T6	MIDI IN/OUT/THRU	OK/NG
T7	1k Hz OUTPUT L 発音	OUTPUT L: +4.0 ±2 dBm (負荷 10k Ω) OUTPUT R: less than -72.0 dBm (負荷 10k Ω) PHONES (L): -2.9 ±2 dBm (負荷 33 Ω) PHONES (R): less than -72.0 dBm (負荷 33 Ω)
T8	1k Hz OUTPUT R 発音	OUTPUT R: +4.0 ±2 dBm (負荷 10k Ω) OUTPUT L: less than -72.0 dBm (負荷 10k Ω) PHONES (R): -2.9 ±2 dBm (負荷 33 Ω) PHONES (L): less than -72.0 dBm (負荷 33 Ω)
T9	EQ-LOW 発音	
T10	EQ-HIGH 発音	
T11	FX DRAM	
T12	8CH 発音	聴感
T13	KNOB1	OK,0-10-120-127-120-10-0
T14	KNOB2	OK,0-10-120-127-120-10-0
T15	KNOB3	OK,0-10-120-127-120-10-0
T16	KNOB4	OK,0-10-120-127-120-10-0
T17	KNOB5	OK,0-10-120-127-120-10-0
T18	KNOB6	OK,0-10-120-127-120-10-0
T19	KNOB7	OK,0-10-120-127-120-10-0
T20	KNOB8	OK,0-10-120-127-120-10-0
T21	PITCH BEND	OK,64-0-127-0-64
T22	MODULATION WHEEL	OK,0-10-120-127-120-10-0
T23	RIBBON X	OK,0-10-120-127-120-10-0-128
T24	RIBBON Z	OK,00-02-09-120-127-120-09-00-02
T25	AFTER TOUCH	OK,00-02-09-120-127-120-09-00-02
T26	FOOT VOLUME	OK,0-10-120-127-120-10-0
T27	FOOT CONTROLLER(QS)	OK,0-10-120-127-120-10-0
T28	FOOT SWITCH	OK,0-1-0
T29	FACTORY SET	OK
T30	EXIT(NOISE LEVEL)	OUTPUT(L,R): less than -83.0 dBm (負荷 10k Ω) PHONES(L,R): less than -90.0 dBm (負荷 33 Ω)

測定器: 周波数カウンター、オシロスコープ、レベル計 (JIS-C フィルター付き)、歪率計 (FLAT)、キーボードアンプなど

### A. テストプログラムの起動

[0]と[-]と[+]のスイッチを同時に押さえながら、電源を立ち上げると次の画面が表示されます。

```
Test Mode
##. ##
```

しばらくすると、次の画面が表示されます。

```
01:RAM
```

PROGURAM[+]と PROGURAM[-]を使用してテストの選択を行います。

### B. テストの進め方

テストプログラムを起動すると次の画面が表示されます。

```
01:RAM
```

PROGURAM[+]と PROGURAM[-]を使用してテストの選択を行い、[STORE]を押して実行させます。

PROGURAM[+]を押すと、現在選択されているテストの次のテストが選択され、テスト項目が表示されます。

PROGURAM[-]を押すと、現在選択されているテストの一つ前のテストが選択され、テスト項目が表示されます。

[STORE]を押すと現在選択されているテストが実行されます。テストの結果がOKなら、そのテスト以降のテストが順次実行されます。

[PORTAMENTO]をテスト実行中に押すと、実行中のテストを中断し、テスト実行前の状態に戻ります。

### C. NG と判断した時のテストの進め方

テスト実行中にエラーが発生すると、エラー表示を行ってテストは止まります。この時は、[PORTAMENTO]を押してエラー処理を行わせた後、PROGRAM[+]と PROGRAM[-]を使用して、実行したいテストを選択します。そして、[STORE]を押して実行します。

### D. イニシャライズ

[7]と[8]と[9]のスイッチを同時に押さえながら、電源を立ち上げると、イニシャライズが実行されます。

### T1. RAM READ/WRITE

```
01:RAM
```

SRAMのリード/ライト/ベリファイテストが、自動的に行われます。

#### 判定結果の表示

```
OK 01:RAM
    OK
```

```
NG 01:RAM
    NG
```

#### テストの終了方法

判定結果を表示して、終了します。

#### その他

すべてのRAMデータは、自動的に保存されます。

### T2. BATTERY

```
02:BATTERY
```

RAMのバックアップバッテリーの電圧が、2.8Vから3.5Vの範囲にあるかを、自動的にチェックします。

#### 判定結果の表示

```
OK 02:BATTERY
    OK
```

```
NG 02:BATTERY
    NG
```

#### テストの終了方法

判定結果を表示して、終了します。

### T3. LCD

テストが開始されると、LCDの全ドットが黒と白にブリンクしますので、黙視により全ドットが正常であることを確認します。

#### テストの終了方法

[STORE]を押すとテストは終了し、次の仕事に進みます。

#### T4. PANEL SWITCH

04:Sw&LED  
Scen2

[SCENE2]からロータリースイッチの[Rota6]のパネルスイッチを、LED の表示に従って ON/OFF します。

04:Sw&LED  
Scen2

LCDは次にチェックするスイッチを表示します。そのスイッチに対応する LED があれば、その LED は点滅します。スイッチが押されてチェックが正常の時は、正弦波が発音し、対応する LED がある場合は LED は消灯して、LCD は次のチェックスイッチを表示します。全てのチェックが終わり、全ての結果が正常の場合は、LCD に OK の表示が出ます。

なお、LCD に表示されていないスイッチを押しても、反応しません。

##### 判定結果の表示

OK 04:Sw&LED  
OK

NG 表示なし

##### テストの終了方法

全てのスイッチが正常と判断されると、LCD に OK と表示されて、テストは終了し次のテストへと進みます。

#### T5. KEYBOARD

05:KBD  
C1

C1 から C6 までの 61 鍵を、スケーリングして、全ての鍵盤が正常に動作することを確認します。

05:KBD  
G#3

(G#3 のチェックの場合)

LCD の表示に従って、鍵盤を KEY ON します。正常な場合は、その鍵盤に応じた音程の正弦波が出力されます。すべての鍵盤が正常にチェックされれば、LCD に OK と表示されます。

なお、LCD に表示されている鍵盤以外を KEY ON しても、無視されます。

##### 判定結果の表示

OK 05:KBD  
OK

NG 表示なし

##### テストの終了方法

全て鍵盤が正常と判断されると、LCD に OK と表示されて、テストは終了し次のテストへと進みます。

#### T6. MIDI

06:MIDI

MIDI IN 端子と MIDI OUT 端子を、MIDI ケーブルで接続した後にテストを実行します。

##### 判定結果の表示

OK 06:MIDI  
OK

NG 06:MIDI  
NG

##### テストの終了方法

結果が LCD に表示されると、テストは終了します。その結果が正常の時は、次のテストへと進みます。

#### T7. 1k Hz OUTPUT L 発音

07:OUTL 1k

OUTPUT-L 及び PHONES(L)より、正常な信号が出力されていることを確認します。

OUTPUT-L、OUTPUT-R、PHONES(L/R)共にプラグを差し込み、各出力の周波数、出力波形、出力レベルを、周波数カウンター、オシロスコープ、レベル計 (JIS-C フィルター付き) で観測します。

この時、VOLUME コントロールは最大とします。又発音中は、LCD に以下の様に表示されます。

07;OUTL 1k  
Doing

#### チェック項目

OUTPUT L: 1k Hz  $\pm 1.5$  Hz、正弦波、  
+4.0  $\pm 2$  dBm (負荷 10k  $\Omega$ )  
OUTPUT R: -72dBm 以下 (負荷 10k  $\Omega$ )  
PHONES(L): 1k Hz  $\pm 1.5$  Hz、正弦波、  
-2.9  $\pm 2$  dBm (負荷 33  $\Omega$ )  
PHONES(R): -72dBm 以下 (負荷 33  $\Omega$ )

#### テストの終了方法

[PORTAMENTO]を押すと、発音が終了して、テスト選択の状態となります。

[STORE]を押すと、発音が終了して、次のテストが実行されます。

#### T8. 1k Hz OUTPUT R 発音

08;OUTR 1k

OUTPUT-R 及び PHONES(R)より、正常な信号が出力されていることを確認します。

OUTPUT-L、OUTPUT-R、PHONES(L/R)共にプラグを差し込み、各出力の周波数、出力波形、出力レベルを、周波数カウンター、オシロスコープ、レベル計 (JIS-C フィルター付き) で観測します。

この時、VOLUME コントロールは最大とします。又発音中は、LCD に以下の様に表示されます。

08;OUTR 1k  
Doing

#### チェック項目

OUTPUT L: -72dBm 以下 (負荷 10k  $\Omega$ )  
OUTPUT R: 1k Hz  $\pm 1.5$  Hz、正弦波、  
+4.0  $\pm 2$  dBm (負荷 10k  $\Omega$ )  
PHONES(L): -72dBm 以下 (負荷 33  $\Omega$ )  
PHONES(R): 1k Hz  $\pm 1.5$  Hz、正弦波、  
-2.9  $\pm 2$  dBm (負荷 33  $\Omega$ )

#### テストの終了方法

[PORTAMENTO]を押すと、発音が終了して、テスト選択の状態となります。

[STORE]を押すと、発音が終了して、次のテストが実行されます。

#### T9. EQ OUTPUT-LOW 発音

09;Low EQ

OUTPUT より、正常な信号が出力されていることを確認します。

出力レベルを、オシロスコープ、レベル計 (FLAT フィルター) で観測します。

この時、VOLUME コントロールは最大とします。又発音中は、LCD に以下の様に表示されます。

09;Low EQ  
Doing

#### チェック項目

OUTPUT L: T7 で測定した 1k Hz のレベルに対して +1.5  $\pm 1$  dB の出力差があること

OUTPUT R: T8 で測定した 1k Hz のレベルに対して +1.5  $\pm 1$  dB の出力差があること

#### テストの終了方法

[PORTAMENTO]を押すと、発音が終了して、テスト選択の状態となります。

[STORE]を押すと、発音が終了して、次のテストが実行されます。

#### T10. EQ OUTPUT -LOW 発音

10;High EQ

OUTPUT より、正常な信号が出力されていることを確認します。

出力レベルを、オシロスコープ、レベル計 (FLAT フィルター) で観測します。

この時、VOLUME コントロールは最大とします。又発音中は、LCD に以下の様に表示されます。

10;High EQ  
Doing

#### チェック項目

OUTPUT L: T7 で測定した 1k Hz のレベルに対して +2.0  $\pm 1$  dB の出力差があること

OUTPUT R: T8 で測定した 1k Hz のレベルに対して +2.0  $\pm 1$  dB の出力差があること



**テストの終了方法**

[PORTAMENTO]を押すと、発音が終了して、テスト選択の状態となります。

[STORE]を押すと、発音が終了して、次のテストが実行されます。

**T11. EFFECT DRAM**

11;FX DRAM

OUTPUT より、正常な信号が出力されていることを確認します。

出力レベルを、オシロスコープ、レベル計 (JIS-C フィルター付き) で観測します。

この時、VOLUME コントロールは最大とします (最短でも、2 秒以上観測すること)。又発音中は、LCD に以下の様に表示されます。

11;FX DRAM  
Doing

**チェック項目**

OUTPUT L: 1k Hz  $\pm 3$  Hz、正弦波、  
+4.0  $\pm 2$  dBm (負荷 10k  $\Omega$ )

**テストの終了方法**

[PORTAMENTO]を押すと、発音が終了して、テスト選択の状態となります。

[STORE]を押すと、発音が終了して、次のテストが実行されます。

**T12. 8CH 発音**

12;8ch

OUTPUT より、正常な信号が出力されていることを確認します。

出力レベルを、オシロスコープ、レベル計 (JIS-C フィルター付き) で観測します。

この時、VOLUME コントロールは最大とします。又発音中は、LCD に以下の様に表示されます。

12;8ch  
XX yy

(xx: 現在 Lch で発音しているチャンネル番号、  
yy: 現在 Rch で発音しているチャンネル番号)

**チェック項目**

聴感により、8 音が正常に発音されることを確認

します。

また、出力波形が正弦波 (1k Hz) であることも確認します。

**テストの終了方法**

[PORTAMENTO]を押すと、発音が終了して、テスト選択の状態となります。

[STORE]を押すと、発音が終了して、次のテストが実行されます。

**T13. KNOB 1 (ASSIGN 1)**

13;Kn1 xxx  
000

(xxx: 現在の Knob 1 の値)

Knob1 が正常に動作することを確認します。

Knob1 を以下の様な LCD の表示に従って、00-64-127-64-00 (下-中央-上-中央-下) と、滑らかに動かします。

13;Kn1 xxx  
yyy

(xxx: 現在の Knob 1 の位置、yyy: 次の目標値)

**判定結果の表示**

OK 13;Kn1 xxx  
OK

NG 表示なし

**テストの終了方法**

判定結果を LCD に表示して、テストを終了します。

**T14. KNOB 2 (ASSIGN 2)****T15. KNOB 3 (ASSIGN 3)****T16. KNOB 4 (ASSIGN 4)****T17. KNOB 5 (ASSIGN 5)****T18. KNOB 6 (ASSIGN 6)****T19. KNOB 7 (ASSIGN 7)****T20. KNOB 8 (ASSIGN 8)**

以上のテストは、T13. KNOB 1 と同様に実行します。

**T21. PITCH BEND**

21;PB xxx  
000

(xxx: 現在の PITCH ホイールの位置)

PITCH ホイールが正常に動作することを確認します。

PITCH ホイールが以下の様な LCD の表示に従って、64-00-127-00（中央-下-上-下）と滑らかに動かします。

21;PB xxx yyy
------------------

(xxx: 現在の PITCH ホイールの位置、  
yyy: 次の目標値)

#### 判定結果の表示

OK	21;PB xxx OK
----	-----------------

NG 表示なし

#### テストの終了方法

判定結果を LCD に表示して、テストを終了します。

### T22. MODULATION WHEEL

22;MW xxx 000
------------------

(xxx: 現在の MODULATION ホイールの位置)

MODULATION ホイールが正常に動作することを確認します。

MODULATION ホイールが以下の様な LCD の表示に従って、00-127-00（下-上-下）と滑らかに動かします。

22;MW xxx yyy
------------------

(xxx: 現在の MODULATION ホイールの位置、  
yyy: 次の目標値)

#### 判定結果の表示

OK	22;MW xxx OK
----	-----------------

NG 表示なし

#### テストの終了方法

判定結果を LCD に表示して、テストを終了します。

### T23. RIBBON X

23;RbX xxx 000
-------------------

(xxx: 現在の RIBBON X の位置)

RIBBON X が正常に動作することを確認します。  
RIBBON の左端を指で押さえ以下の様な LCD の表示に従って、00-127-00（左-右-左）と滑らかに指を動かし、最後に指を離します。

23;RbX xxx yyy
-------------------

(xxx: 現在の RIBBON X の位置、  
yyy: 次の目標値)

#### 判定結果の表示

OK	23;RbX 128 OK
----	------------------

NG 表示なし

#### テストの終了方法

判定結果を LCD に表示して、テストを終了します。

### T24. RIBBON Z

24;RbZ 000 9-120
---------------------

(xxx: 現在の RIBBON Z の位置)

RIBBON Z が正常に動作することを確認します。  
RIBBON の中央付近を指で触れ以下の様な LCD の表示に従って、00-127-00（弱-強-弱）と RIBBON を指で押さえます。

24;RbZ xxx yyy
-------------------

(xxx: 現在の RIBBON Z の位置、  
yyy: 次の目標値)

#### 判定結果の表示

OK	24;RbZ 000 OK
----	------------------

NG 表示なし

**テストの終了方法**

判定結果を LCD に表示して、テストを終了します。

**T24. AFTER TOUCH**

```
25;AT 000
9-120
```

AFTER TOUCH が正常に動作することを確認します。

鍵盤番号 D3 の白鍵を指で触れ以下のような LCD の表示に従って、00-127-00（弱-強-弱）と指で押さえ、最後に指を離します。

```
25;AT xxx
yyy
```

(xxx: 現在の AFTER TOUCH の位置、  
yyy: 次の目標値)

**判定結果の表示**

```
OK 25;AT xxx
OK
```

NG 表示なし

**テストの終了方法**

判定結果を LCD に表示して、テストを終了します。

**T26. FOOT VOLUME**

```
26;FV xxx
000
```

(xxx: 現在の FOOT VOLUME の位置)

FOOT VOLUME が正常に動作することを確認します。

FOOT VOLUME を、以下のような LCD の表示に従って、00-127-00（上-下-上）と滑らかに動かします。

```
26;FV xxx
yyy
```

(xxx: 現在の FOOT VOLUME の位置、  
yyy: 次の目標値)

**判定結果の表示**

```
OK 26;FV xxx
OK
```

NG 表示なし

**テストの終了方法**

判定結果を LCD に表示して、テストを終了します。

**T27. FOOT CONTROLLER**

```
27;FC xxx
000
```

(xxx: 現在の FOOT CONTROLLER の位置)

FOOT CONTROLLER が正常に動作することを確認します。

FOOT CONTROLLER を、以下のような LCD の表示に従って、00-127-00（上-下-上）と滑らかに動かします。

```
27;FC xxx
yyy
```

(xxx: 現在の FOOT CONTROLLER の位置、  
yyy: 次の目標値)

**判定結果の表示**

```
OK 27;FC xxx
OK
```

NG 表示なし

**テストの終了方法**

判定結果を LCD に表示して、テストを終了します。

**T28. FOOT SWITCH**

```
28;FS off
ON
```

FOOT SWITCH が正常に動作することを確認します。

FOOT SWITCH を、以下のような LCD の表示に従って、ON-off（下-上）と動かします。

```
28;FS xxx
yyy
```

(xxx: 現在の FOOT VOLUME の位置、  
yyy: 次の目標値)

## 判定結果の表示

OK 28;FS off  
OK

NG 表示なし

## テストの終了方法

判定結果を LCD に表示して、テストを終了します。

## T29. FACTORY SETTINGS

29;FACTSET

各データを初期化して、工場出荷データにセットします。

[STORE]を押すと、ファクトリーセットを実行した後、テストプログラムを終了します。ファクトリーセットが終了すると、各データは右の様にセットされます。

## T30. EXIT TEST PROGRAM

30;EXIT

[STORE]を離すと、テストモードから抜けるかどうかの確認が表示されます。

30;EXIT  
Sure?

この表示の時、[STORE]を押すとテストモードから抜けることができます。[PORTAMENTO]を押すと、テスト選択の状態に戻ります。

ファクトリーセットを実行してテストを終了した後、一度も鍵盤キーを ON していないときのノイズレベルが、以下の範囲にあることを確認して下さい。

測定には、レベル計 (JIS-C フィルター付き) を使用して下さい。

OUTPUT L: -83 dBm 以下 (負荷 10k Ω)

OUTPUT R: -83 dBm 以下 (負荷 10k Ω)

PHONES L: -90 dBm 以下 (負荷 33 Ω)

PHONES R: -90 dBm 以下 (負荷 33 Ω)

(工場出荷時のセッティングデータ)

## SYSTEM SETUP

System Setup	Data
Master Tune	+0(cent)
Master Volume	127
Keyboard Transpose	+0
Keyboard Velocity Curve	wide
Keyboard Fix Velocity	off
Midi Keyboard Transmit Channel	01
Midi Arp/SEQ Transmit Channel	off
Midi Receive Channel 1	01
Midi Receive Channel 2	01
Midi Device Number	all
Midi Local	on
MW Control Number	01
FC Control Number	04
FV Control Number	07
Ribbon X Control Number	13
Ribbon Y Control Number	12
Data Knob1 Control Number	41
Data Knob2 Control Number	42
Data Knob3 Control Number	43
Data Knob4 Control Number	44
Data Knob5 Control Number	45
Data Knob6 Control Number	46
Data Knob7 Control Number	47
Data Knob8 Control Number	48
Foot Switch Control Number	64
Scene Controller Number	01

## USER VOICE

Factory Set データが、128 User Voice 分、ROM より自動的にセットされます。

## USER PATTERN

Factory Set データが、128 User Pattern 分、ROM より自動的にセットされます。

出荷時のモードと音色番号など

Voice 番号は User Voice 1

音色番号セット後に、Data Knob を動かしたり Scene Sw.を押したりすると Edit Mark が出ることがあるので、先に Knob を下記の位置にセットしてから、音色番号を 1 にセットしてください。

Data Knob 1-8	最左
Edit Rotary Select Knob	一番上
Volume Knob	最小
Pitch Bend Wheel	中央
Modulation Wheel	最小

# MIDI DATA FORMAT (MIDIデータフォーマット)

Many MIDI messages listed in the MIDI Data Format section are expressed in hexadecimal or binary numbers. Hexadecimal numbers may include the letter "H" as a suffix. The letter "n" indicates a certain whole number. The chart below lists the corresponding decimal number for each hexadecimal/binary number.

Decimal	Hexadecimal	Binary	Decimal	Hexadecimal	Binary
0	00	0000 0000	64	40	0100 0000
1	01	0000 0001	65	41	0100 0001
2	02	0000 0010	66	42	0100 0010
3	03	0000 0011	67	43	0100 0011
4	04	0000 0100	68	44	0100 0100
5	05	0000 0101	69	45	0100 0101
6	06	0000 0110	70	46	0100 0110
7	07	0000 0111	71	47	0100 0111
8	08	0000 1000	72	48	0100 1000
9	09	0000 1001	73	49	0100 1001
10	0A	0000 1010	74	4A	0100 1010
11	0B	0000 1011	75	4B	0100 1011
12	0C	0000 1100	76	4C	0100 1100
13	0D	0000 1101	77	4D	0100 1101
14	0E	0000 1110	78	4E	0100 1110
15	0F	0000 1111	79	4F	0100 1111
16	10	0001 0000	80	50	0101 0000
17	11	0001 0001	81	51	0101 0001
18	12	0001 0010	82	52	0101 0010
19	13	0001 0011	83	53	0101 0011
20	14	0001 0100	84	54	0101 0100
21	15	0001 0101	85	55	0101 0101
22	16	0001 0110	86	56	0101 0110
23	17	0001 0111	87	57	0101 0111
24	18	0001 1000	88	58	0101 1000
25	19	0001 1001	89	59	0101 1001
26	1A	0001 1010	90	5A	0101 1010
27	1B	0001 1011	91	5B	0101 1011
28	1C	0001 1100	92	5C	0101 1100
29	1D	0001 1101	93	5D	0101 1101
30	1E	0001 1110	94	5E	0101 1110
31	1F	0001 1111	95	5F	0101 1111
32	20	0010 0000	96	60	0110 0000
33	21	0010 0001	97	61	0110 0001
34	22	0010 0010	98	62	0110 0010
35	23	0010 0011	99	63	0110 0011
36	24	0010 0100	100	64	0110 0100
37	25	0010 0101	101	65	0110 0101
38	26	0010 0110	102	66	0110 0110
39	27	0010 0111	103	67	0110 0111
40	28	0010 1000	104	68	0110 1000
41	29	0010 1001	105	69	0110 1001
42	2A	0010 1010	106	6A	0110 1010
43	2B	0010 1011	107	6B	0110 1011
44	2C	0010 1100	108	6C	0110 1100
45	2D	0010 1101	109	6D	0110 1101
46	2E	0010 1110	110	6E	0110 1110
47	2F	0010 1111	111	6F	0110 1111
48	30	0011 0000	112	70	0111 0000
49	31	0011 0001	113	71	0111 0001
50	32	0011 0010	114	72	0111 0010
51	33	0011 0011	115	73	0111 0011
52	34	0011 0100	116	74	0111 0100
53	35	0011 0101	117	75	0111 0101
54	36	0011 0110	118	76	0111 0110
55	37	0011 0111	119	77	0111 0111
56	38	0011 1000	120	78	0111 1000
57	39	0011 1001	121	79	0111 1001
58	3A	0011 1010	122	7A	0111 1010
59	3B	0011 1011	123	7B	0111 1011
60	3C	0011 1100	124	7C	0111 1100
61	3D	0011 1101	125	7D	0111 1101
62	3E	0011 1110	126	7E	0111 1110
63	3F	0011 1111	127	7F	0111 1111

**Additional Notes**

- For example, 144 = 159(Decimal)/96H(1001 0000 - 1001 1111(Binary)) indicate the note-on messages for the channels 1 through 16 respectively. 176 = 191(Hex)/1011 0000 - 1011 1111 indicate the control change messages for the channels 1 through 16 respectively. 202 = 207(CnH)/100 0000 - 1100 1111 indicate the program change messages for the channels 1 through 16 respectively. 240/FOH/1111 0000 is positioned at the beginning of data to indicate a system exclusive message. 247/7H/1111 0111 is positioned at the end of the system exclusive message.
- aaH(Hexadecimal)/0aaaaaH(Binary) indicates the data addresses. The data address consists of High, Mid and Low.
- bbH/0bnnnnbb indicates byte counts.
- ccH/0cccccc indicates checksums.
- ddH/0ddd3ddd indicates data values.

**Synthesizer Section**

**(1) TRANSMIT FLOW**

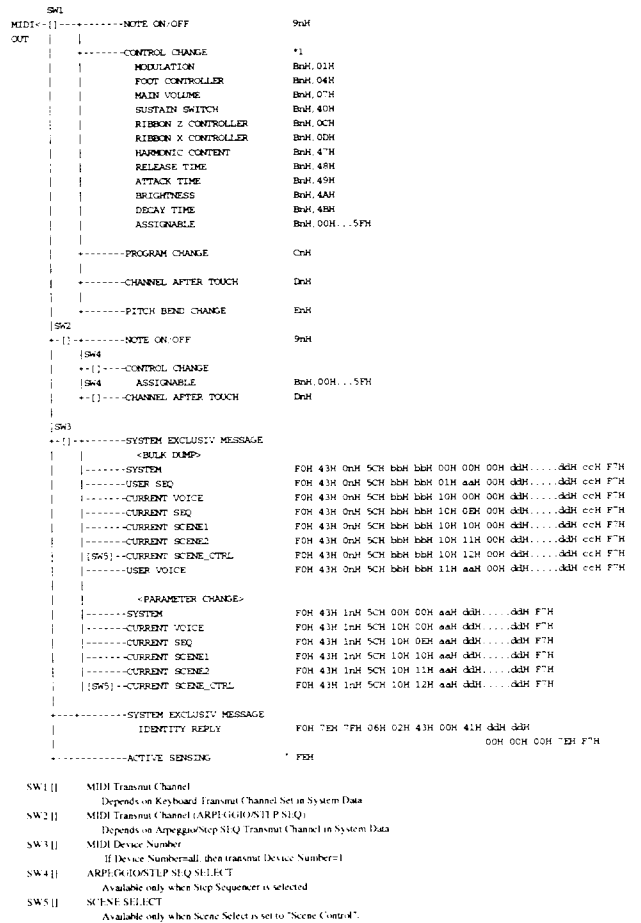

\*1: If Control Change Mode is "mode2", then additional Control Change numbers are transmitted. (See 3-1-6.)

**(2) RECEIVE FLOW**

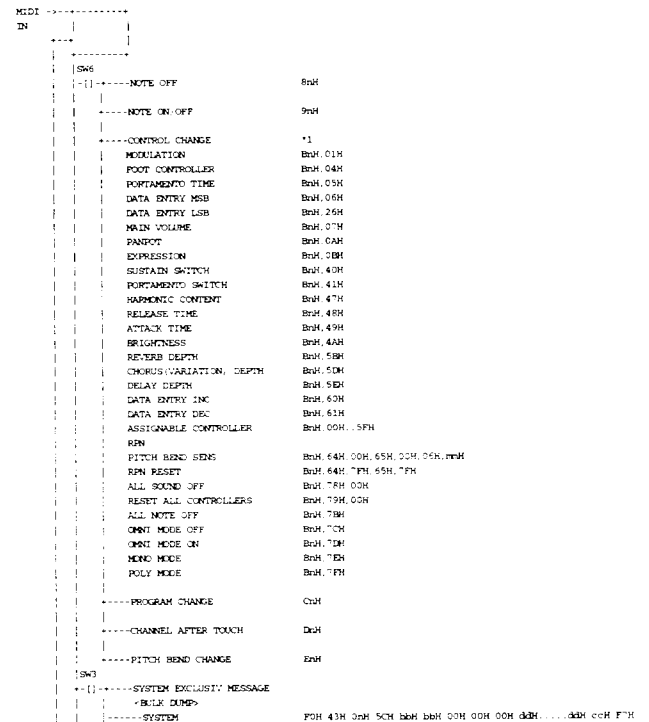

```

|-----USER SEQ          F0H 43H 00H 5CH b8H b8H 01H aAH 00H d8H .....d8H e0H F7H
|-----CURRENT VOICE     F0H 43H 00H 5CH b8H b8H 10H 00H 00H d8H .....d8H e0H F7H
|-----CURRENT SEQ       F0H 43H 00H 5CH b8H b8H 10H 00H 00H d8H .....d8H e0H F7H
|-----CURRENT SCENE1    F0H 43H 00H 5CH b8H b8H 10H 10H 00H d8H .....d8H e0H F7H
|-----CURRENT SCENE2    F0H 43H 00H 5CH b8H b8H 10H 11H 00H d8H .....d8H e0H F7H
|[SW5]-CURRENT SCENE_CTRL F0H 43H 00H 5CH b8H b8H 10H 12H 00H d8H .....d8H e0H F7H
|-----USER VOICE        F0H 43H 00H 5CH b8H b8H 11H aAH 00H d8H .....d8H e0H F7H
|
|-----PARAMETER CHANGES
|-----EQ1 MASTER TUNING F0H 43H 10H 04H 40H d8H F7H
|-----SYSTEM            F0H 43H 10H 5CH 00H 00H aAH d8H .....d8H F7H
|-----CURRENT VOICE     F0H 43H 10H 5CH 10H 00H aAH d8H .....d8H F7H
|-----CURRENT VOICE_SEQ F0H 43H 10H 5CH 10H 00H aAH d8H .....d8H F7H
|-----CURRENT SCENE1    F0H 43H 10H 5CH 10H 10H aAH d8H .....d8H F7H
|-----CURRENT SCENE2    F0H 43H 10H 5CH 10H 11H aAH d8H .....d8H F7H
|[SW5]-CURRENT SCENE_CTRL F0H 43H 10H 5CH 10H 12H aAH d8H .....d8H F7H
|-----USER VOICE        F0H 43H 10H 5CH 10H 11H aAH 00H F7H
|
|-----BULK_DUMP_REQUEST
|-----SYSTEM            F0H 43H 20H 5CH 00H 00H 00H F7H
|-----USER SEQ          F0H 43H 20H 5CH 01H aAH 00H F7H
|-----CURRENT VOICE     F0H 43H 20H 5CH 10H 00H 00H F7H
|-----CURRENT VOICE_SEQ F0H 43H 20H 5CH 10H 00H 00H F7H
|-----CURRENT SCENE1    F0H 43H 20H 5CH 10H 10H 00H F7H
|-----CURRENT SCENE2    F0H 43H 20H 5CH 10H 11H 00H F7H
|[SW5]-CURRENT SCENE_CTRL F0H 43H 20H 5CH 10H 12H 00H F7H
|-----USER VOICE        F0H 43H 20H 5CH 11H aAH 00H F7H
|
|-----SYSTEM EXCLUSIVE MESSAGE
|-----MIDI MASTER VOLUME F0H 7FH 7FH 0AH 01H 11H aAH F7H
|-----IDENTITY REQUEST  F0H 7EH 00H 0AH 01H F7H
|
|-----SYSTEM EXCLUSIVE MESSAGE
|-----TEST ENTRY        F0H 43H 10H 18H 5AH 00H F7H
|-----LCD HARD COPY     F0H 43H 10H 18H 5AH 01H F7H
|
|-----TIMING CLOCK      F7H
|-----ACTIVE SENSING    F6H

```

SW1[] MIDI Device Number  
 SW4[] ARPEGGIO/STEP SEQ SELECT  
 Available only when Step Sequencer is selected  
 SW5[] SCENE SELECT  
 Available only when Scene Select is set to "Scene Control"  
 SW6[] MIDI Receive Channel  
 Depends on Receive Channel set in System Data.

\*1: If Control Change Mode is "mode2", then additional Control Change numbers are received. (See (3-1-1).)

(3) TRANSMIT/RECEIVE DATA

(3-1) CHANNEL VOICE MESSAGES

(3-1-1) NOTE OFF

STATUS 100nnnn (9nH) n = 0 ~ 15: MIDI RECEIVE CHANNEL  
 NOTE NUMBER 00000000 k = 0 (C)-127 (G#)  
 VELOCITY 00000000 ignores "k"

Receive only

(3-1-2) NOTE ON/OFF

STATUS 100nnnn (9nH) n = 0 ~ 15: MIDI TRANSMIT/RECEIVE CHANNEL  
 NOTE NUMBER 00000000 k = 0 (C)-127 (G#); when receiving  
 k = 36 (C1)-96 (G6); when transmitting  
 VELOCITY 00000000 k = 0 (C)-127 (G#); selectable when transposed  
 00000000 (v=0) NOTE ON  
 00000000 (v=0) NOTE OFF

(3-1-3) PROGRAM CHANGE

STATUS 110nnnn (CnH) n = 0 ~ 15: MIDI TRANSMIT/RECEIVE CHANNEL  
 PROGRAM NUMBER 00000000 p = 0 ~ 127

(3-1-4) CHANNEL AFTER TOUCH

STATUS 1101nnnn (DnH) n = 0 ~ 15: MIDI TRANSMIT/RECEIVE CHANNEL  
 VALUE 00000000 v = 0 ~ 127 AFTER TOUCH VALUE

(3-1-5) PITCH BEND CHANGE

STATUS 1110nnnn (E8nH) n = 0 ~ 15: MIDI TRANSMIT/RECEIVE CHANNEL  
 LSB 00000000 PITCH BEND CHANGE LSB  
 MSB 00000000 PITCH BEND CHANGE MSB

Transmitted with a resolution of 7 bits.

(3-1-6) CONTROL CHANGE

STATUS 1011nnnn (B8nH) n = 0 ~ 15: MIDI TRANSMIT/RECEIVE CHANNEL  
 CONTROL NUMBER 00000000 c = CONTROL NUMBER  
 CONTROL VALUE 00000000 v = DATA VALUE

\* TRANSMITTED CONTROL NUMBERS  
 c = 1 MODULATION : v = 0 ~ 127 \*1  
 c = 4 FOOT CONTROLLER : v = 0 ~ 127 \*1  
 c = 7 MAIN VOLUME : v = 0 ~ 127 \*1  
 c = 12 RIBBON Z CONTROLLER : v = 0 ~ 127 \*1  
 c = 17 RIBBON X CONTROLLER : v = 0-64 + 64.0 ~ 127+63 \*1  
 c = 64 SUSTAIN SWITCH : v = 0-63:OFF, 64-127:ON \*1  
 c = 71 HARMONIC CONTENT : v = 0 ~ 127 \*1  
 c = 72 RELEASE TIME : v = 0 ~ 127 \*1  
 c = 73 ATTACK TIME : v = 0 ~ 127 \*1  
 c = 74 BRIGHTNESS : v = 0 ~ 127 \*1  
 c = 75 DECAY TIME : v = 0 ~ 127 \*1  
 c = 00...95 ASSIGNABLE CONT : v = 0 ~ 127 \*1

\* RECEIVED CONTROL NUMBER  
 c = 1 MODULATION : v = 0 ~ 127 \*1  
 c = 4 FOOT CONTROLLER : v = 0 ~ 127 \*1  
 c = 5 PORTAMENTO TIME : v = 0 ~ 127 \*1  
 c = 6 DATA ENTRY MSB : v = 0 ~ 127 \*2  
 c = 38 DATA ENTRY LSB : v = 0 ~ 127 \*2  
 c = 7 MAIN VOLUME : v = 0 ~ 127 \*1  
 c = 10 PANPOT : v = 0 ~ 127 \*1  
 c = 11 EXPRESSION : v = 0 ~ 127 \*1  
 c = 12 RIBBON Z CONTROLLER : v = 0 ~ 127 \*1  
 c = 13 RIBBON X CONTROLLER : v = 0-64 + 64.0 ~ 127+63 \*1  
 c = 64 SUSTAIN SWITCH : v = 0-63:OFF, 64-127:ON \*1  
 c = 65 PORTAMENTO SWITCH : v = 0-63:OFF, 64-127:ON \*1  
 c = 71 HARMONIC CONTENT : v = 0 ~ 127 \*1

(VCF FILTER RESONANCE)  
 RELEASE TIME : v = 0 ~ 127  
 (AMP EG RELEASE TIME)  
 ATTACK TIME : v = 0 ~ 127  
 (AMP EG ATTACK TIME)  
 BRIGHTNESS : v = 0 ~ 127  
 (VCF FILTER CUTOFF)  
 DECAY TIME : v = 0 ~ 127  
 REVERB DEPTH : v = 0 ~ 127  
 CHORUS (VARIATION) DEPTH : v = 0 ~ 127  
 DELAY DEPTH : v = 0 ~ 127  
 DATA ENTRY INC : v = 127 \*2  
 DATA ENTRY DEC : v = 127 \*2  
 ASSIGNABLE CONTROLLER : v = 0 ~ 127

\*1: Preset CONTROL CHANGE NUMBER at the factory. Can be changed.  
 \*2: Used only when assigning the parameter with RPN numbers.

In addition, the following CONTROL NUMBERS will be transmitted/received when Control Change Mode 2 is selected. (These are unique to the AN1x and therefore not in accordance with the MIDI 1.0 standard.)

c = 3 SCENE SELECT : v = 0 ~ 127  
 c = 8 LAYER MODE : v = 0 ~ 127  
 c = 9 POLY/MONO MODE : v = 0 ~ 127  
 c = 14 LFO RESET MODE : v = 0 ~ 127  
 c = 15 LFO1 WAVE : v = 0 ~ 127  
 c = 16 LFO1 SPEED : v = 0 ~ 127  
 c = 17 LFO2 SPEED : v = 0 ~ 127  
 c = 18 VCO1 PITCH MOD DEPTH : v = 0 ~ 127  
 c = 19 VCF FILTER MOD DEPTH : v = 0 ~ 127  
 c = 20 LFO1 DELAY : v = 0 ~ 127  
 c = 21 VCO1 PITCH COARSE TUNE : v = 0 ~ 127  
 c = 22 VCO SYNC PITCH : v = 0 ~ 127  
 c = 23 VCO SYNC PITCH DEPTH : v = 0 ~ 127  
 c = 24 VCO SYNC PITCH SOURCE : v = 0 ~ 127  
 c = 25 FBG DEPTH : v = 0 ~ 127  
 c = 26 FBG SWITCH : v = 0 ~ 127  
 c = 27 FBG DECAY : v = 0 ~ 127  
 c = 28 FBG SUSTAIN LEVEL : v = 0 ~ 127  
 c = 29 FBG RELEASE : v = 0 ~ 127  
 c = 30 VCF CUTOFF KBD TRACK : v = 0 ~ 127  
 c = 31 AMP EG SUSTAIN LEVEL : v = 0 ~ 127  
 c = 33 VCO ALGORITHM : v = 0 ~ 127  
 c = 34 VCO SYNC PITCH MOD SW : v = 0 ~ 127  
 c = 35 FM DEPTH : v = 0 ~ 127  
 c = 36 FM SOURCE1 : v = 0 ~ 127  
 c = 37 FM SOURCE2 : v = 0 ~ 127  
 c = 39 MIXER NOISE LEVEL : v = 0 ~ 127  
 c = 50 VCO1 WAVE TYPE : v = 0 ~ 127  
 c = 51 VCO2 WAVE TYPE : v = 0 ~ 127  
 c = 52 VCO2 PITCH COARSE TUNE : v = 0 ~ 127  
 c = 53 VCO2 PITCH FINE TUNE : v = 0 ~ 127  
 c = 54 VCO2 EDGE : v = 0 ~ 127  
 c = 55 VCO2 PULSE WIDTH : v = 0 ~ 127  
 c = 56 VCO2 PWM DEPTH : v = 0 ~ 127  
 c = 57 VCO2 PITCH MOD DEPTH : v = 0 ~ 127  
 c = 58 VCF HPF CUTOFF : v = 0 ~ 127  
 c = 59 VCF FILTER TYPE : v = 0 ~ 127  
 c = 60 FILTER EG VELOCITY SENS : v = 0 ~ 127  
 c = 61 AMP EG VELOCITY SENS : v = 0 ~ 127  
 c = 62 VCA VOLUME : v = 0 ~ 127  
 c = 63 VCA FEED BACK LEVEL : v = 0 ~ 127  
 c = 68 MIXER VCO1 LEVEL : v = 0 ~ 127  
 c = 69 MIXER VCO2 LEVEL : v = 0 ~ 127  
 c = 70 RING MODULATOR LEVEL : v = 0 ~ 127  
 c = 76 VCO1 EDGE : v = 0 ~ 127  
 c = 77 VCO1 PITCH FINE TUNE : v = 0 ~ 127  
 c = 78 VCO1 PULSE WIDTH : v = 0 ~ 127  
 c = 79 VCO1 PWM DEPTH : v = 0 ~ 127  
 c = 80 VCA AMP MOD DEPTH : v = 0 ~ 127  
 c = 81 FILTER EG DEPTH : v = 0 ~ 127  
 c = 82 FILTER EG ATTACK : v = 0 ~ 127  
 c = 83 FILTER EG DECAY : v = 0 ~ 127  
 c = 85 PORTAMENTO MODE : v = 0 ~ 127  
 c = 86 VCO1 PWM SOURCE : v = 0 ~ 127  
 c = 87 VCO2 PWM SOURCE : v = 0 ~ 127  
 c = 90 ARPEGGIO/STEP SEQ SW : v = 0 ~ 127

MODULATION is used to control vibrato depth.

PORTAMENTO TIME sets the time it takes for the pitch to reach the next note played when PORTAMENTO SWITCH (CONTROL #65) is set to on. 0 is the minimum time and 127 is the maximum.

PANPOT position relatively changes according to the preset value for each voice.

REVERB DEPTH controls reverb send level.  
 CHORUS DEPTH overwrites the Dry. Wet value of the Variation Effect directly for each voice.  
 DELAY DEPTH controls delay send level.

HARMONIC CONTENT adjusts the resonance preset for each voice. Setting a value adds to or subtracts from the center value 64 since it is an offset parameter. Higher values produce more resonance. The effective range may be narrower than the range you can designate depending on the selected voice.

RELEASE TIME adjusts the envelop release time preset for each voice. Setting a value adds to or subtracts from the center value 64 since it is an offset parameter.

ATTACK TIME adjusts the envelop attack time preset for each voice. Setting a value adds to or subtracts from the center value 64 since it is an offset parameter.

BRIGHTNESS adjusts the cutoff frequency preset for each voice. Setting a value adds to or subtracts from the center value 64 since it is an offset parameter. Lower values produce a warmer sound. The effective range may be narrower than the range you can designate depending on the selected voice.

(3-2) CHANNEL MODE MESSAGES

STATUS 1011nnnn (B8nH) n = 0 ~ 15: MIDI RECEIVE CHANNEL  
 CONTROL NUMBER 00000000 c = CONTROL NUMBER  
 CONTROL VALUE 00000000 v = DATA VALUE

(3-2-1) ALL SOUND OFF (CONTROL NUMBER = 78H, DATA VALUE = 0)

All the sounds currently played including the channel messages such as note-on and hold-on in a certain channel are canceled when receiving this message.

(3-2-2) RESET ALL CONTROLLERS (CONTROL NUMBER = 79H, DATA VALUE = 0)

Reset the values set for the following controllers.

PITCH BEND CHANGE 0 (Center)  
 AFTER TOUCH 0 (Minimum)  
 MODULATION 0 (Minimum)  
 EXPRESSION 127 (Maximum)  
 SUSTAIN SWITCH 0 (Off)

REN	Not assigned (no change)
PARAMETER SELECTOR	0 (Off)
REAR CONTROLER	0 (Minimum)
REAR M1 CONTROLER	4 (No effect)
REAR M2 CONTROLER	0 (Minimum)
VOLUME	127 (Maximum)
SON	04 (No effect)
REAR SPLIT	127 (Maximum)
CHORD/VELOCITY SPLIT	No change
DELAY SPLIT	127 (Maximum)

(3-2-4) ALL NOTE OFF (CONTROL NUMBER = 700, DATA VALUE = 0)

All the notes currently set to on in a certain channel are muted when receiving this message. However, if Hold 1 or Sustain is on, notes will continue sounding until these are turned off.

(3-2-4) OMNI MODE OFF (CONTROL NUMBER = 700, DATA VALUE = 0)

Performs the same function as when receiving ALL NOTES OFF.

(3-2-5) OMNI MODE ON (CONTROL NUMBER = 700, DATA VALUE = 0)

Performs the same function as when receiving ALL NOTES OFF. Not to change to OMNI ON.

(3-2-6) MONO (CONTROL NUMBER = 700, DATA VALUE = 0)

Performs the same function as when receiving ALL SOUNDS OFF. If the 3rd byte (mono) is within 0 through 16, the channel will be Mode4 (m = 1).

(3-2-7) POLY (CONTROL NUMBER = 700, DATA VALUE = 0)

Performs the same function as when receiving ALL SOUNDS OFF. The channel will be Mode3.

(3-3) REGISTERED PARAMETER NUMBER

PARAM	11110000(000)	6 + 0 + 16	MIDI RECEIVE CHANNEL
700	01100100(400)		
RPN LSB	00000000	p	RPN LSB(See chart below)
MSB	01100101(050)	q	RPN MSB(See chart below)
RPN MSB	00000000		
DATA ENTRY MSB	00000110(700)		
DATA VALUE	00000000	m	Data Value
DATA ENTRY LSB	00100110(200)		
DATA VALUE	01111111	l	Data Value

First, designate the parameter using RPN MSB LSB numbers. Then, set its value with data entry MSB LSB.

RPN	DATA ENTRY	PARAMETER NAME	DATA RANGE
120	MSB	120	0 - 127 (0 = 24 semitones)
120	LSB	121	0 - 127 (0 = 24 semitones)
700	MSB	700	0 - 127 (0 = 24 semitones)
700	LSB	701	0 - 127 (0 = 24 semitones)

The interval value is not affected.

(3-4) SYSTEM REAL TIME MESSAGES

(3-4-1) ACTIVE SENSING

STATUS 11111110 (FB0)

Transmitted every 200 msec.

Once this code is received, the AN1x starts sensing. When no status data is received for user approximately 500 ms, MIDI receiving buffer will be cleared, and the sounds currently played and the sustain switch are forcibly turned off. In this case, each control data will be reset to a certain value.

(3-4-2) TIMING CLOCK(Receive only)

STATUS 11111107 (FB8)

Selects whether the tempo clock of the Arpeggiator, Step Sequencer and FreeEG is controlled by internal clock or the timing clock of an external device via MIDI.

(3-5) SYSTEM EXCLUSIVE MESSAGE

(3-5-1) UNIVERSAL NON REALTIME MESSAGE

(3-5-1-1) IDENTITY REQUEST (Receive only)

FSH 700 06B 06B 01H 07H

(3-5-1-2) IDENTITY REPLY (Transmit only)

FSH 700 07H 09H 02H 40H 05H 43H 08H 05H 09H 09H 07H 05H 07H

Device Number (Code) AN1x: 1A 22  
 Vx10 Support Level AN1x: 7E

(3-5-2) UNIVERSAL REALTIME MESSAGE

(3-5-2-1) MIDI MASTER VOLUME

100 700 07H 04H 07H 11H 00H 07H

Set the MASTER VOLUME value.

The value "00" is used to set the master volume (the value "127" will be received).

(3-5-3) PARAMETER CHANGE

(3-5-3-1) DX1 MASTER TUNING

100 43H 16H 24H 40H 06H 07H

When AN1x receives the DX1 compatible format, MASTER TUNE in the System Data will be changed. The value "00" is used to set the master tuning.

00 = 064(00H) = 0140H = 056(70H)

(3-5-3-2) PARAMETER CHANGE

11110000	00	Exclusive status
01000011	43	YAMAHA ID
00010000	06	Device Number
01011100	50	Mode1 ID
00000000	00000000	Address High
00000000	00000000	Address Mid
00000000	00000000	Address Low
00000000	00000000	Data

11110111 07 End of Exclusive

For parameters with data size of 2, transmit the appropriate number of data bytes. See MIDI Data Table for Address and Byte Count.

The following six types of data are transmitted/received.

- System Data
- Current Voice Common Data
- Current Voice Special Data
- Current Voice Special Data
- Current Voice Special Data
- Current Stop SEQ Data

(3-5-4) BULK DUMP

11110000	00	Exclusive status
01000011	43	YAMAHA ID
00010000	06	Device Number
01011100	50	Mode1 ID
00000000	00000000	ByteCount
00000000	00000000	ByteCount
00000000	00000000	Address High
00000000	00000000	Address Mid
00000000	00000000	Address Low
00000000	00	Data
1	1	1
00000000	00000000	Checksum
11110111	07	End of Exclusive

See MIDI Data Table for Address and Byte Count.

The Check sum is the value that results in a value of 0 for the lower 7 bits when the Byte Count, Start Address, Data and Check sum itself are added.

The following eight types of data are transmitted/received.

- System Data
- Current Voice Common Data
- Current Voice Special Data
- Current Voice Special Data
- Current Voice Special Data
- Current Voice Special Data
- User Voice Data
- User Stop SEQ Data

(3-5-5) DUMP REQUEST

11110000	00	Exclusive status
01000011	43	YAMAHA ID
00010000	06	Device Number
01011100	50	Mode1 ID
00000000	00000000	Address High
00000000	00000000	Address Mid
00000000	00000000	Address Low
11110111	07	End of Exclusive

See MIDI Data Table for Address and Byte Count.

The following eight types of data are received.

- System Data
- Current Voice Common Data
- Current Voice Special Data
- Current Voice Special Data
- Current Voice Special Data
- Current Voice Special Data
- User Voice Data
- User Stop SEQ Data

(4) CONFIGURATION OF KEYBOARD, ARPEGGIATOR AND TONE GENERATOR

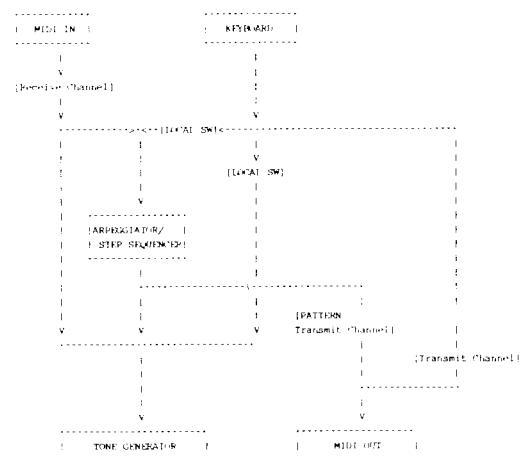

The tone generator will respond to both note data received via MIDI and the data generated by the AN1x such as note data and control data.

ALL SOUNDS OFF clears all the sounds in the specific channel played by both the keyboard and the data via MIDI.

MIDI Data Table <1-1>

Parameter Base Address	Parameter Change Address	Description
SYSTEM	01 05 05	System
USER PATTERN	01 09 20	User Pattern 1 (only Bulk Dump)
CURRENT VOICE	01 07 00	User Pattern 128 (only Bulk Dump)
	10 06 06	Current Voice Common Buffer
	10 19 00	Current Voice Special 1 Buffer
	10 11 00	Current Voice Special 2 Buffer

Table with 3 columns: CURRENT PATTERN, USER VOICE, and values. Shows patterns 10, 11, 12 and voices 00, 01, 02.

MIDI Data Table <1-2>

MIDI Parameter Change Table (System)

MIDI Parameter Change Table (System) table with columns: Address (H), Size (H), Data (H), Parameter Name, Description, Default Value (H), and Range. Lists parameters like Master Tune, Keyboard Transpose, and various MIDI channel numbers.

MIDI Data Table <1-3>

MIDI Parameter Change Table (Current Voice Common Buffer)

MIDI Parameter Change Table (Current Voice Common Buffer) table with columns: Address (H), Size (H), Data (H), Parameter Name, Description, Default Value (H), and Range. Lists parameters like Voice Name 1-10, Common Scene Select, Layer Mode, and various layer parameters.

MIDI Parameter Change Table (Current Voice Scene Buffer) table with columns: Address (H), Size (H), Data (H), Parameter Name, Description, Default Value (H), and Range. Lists parameters like Vari-EF Type, Vari-EF Param 1-6 MSB/LSB, and 3-Band EQ parameters.

MIDI Parameter Change Table (Current Voice Scene Buffer) table (continued) with columns: Address (H), Size (H), Data (H), Parameter Name, Description, Default Value (H), and Range. Lists parameters like Arpeggio/Step Seq and various Arpeggio types.

MIDI Parameter Change Table (Current Voice Scene Buffer) table (continued) with columns: Address (H), Size (H), Data (H), Parameter Name, Description, Default Value (H), and Range. Lists parameters like Free EG Trk Trigger, Free EG Loop Type, and Free EG Length.

MIDI Parameter Change Table (Current Voice Scene Buffer) table (continued) with columns: Address (H), Size (H), Data (H), Parameter Name, Description, Default Value (H), and Range. Lists parameters like Free EG Trk Detail MSB/LSB and Free EG Trk Detail 192 MSB/LSB.

- \*1 See other table (Ctrl Matrix Parameter List)
\*2 See other table (Arpeggio Type List)
\*3 become available only when Step Seq is selected and Kbd Mode = pin.sel/kbdnorm or pin.sel/kbdsw
\*4 only when Arpeggio is selected
\*5 only when Step Seq is selected
\*6 except \*7
\*7 only when Step Seq is selected and Kbd Mode = pin.sel/kbdnorm or pin.sel/kbdsw
\*8 become available only when Step Seq is selected
\*9 see other table (Free EG Trk Parameter List)
\*10 only Bulk Dump (not transmitted and received as parameter change)

MIDI Data Table <1-4>

MIDI Parameter Change Table (Current Voice Scene Buffer)

MIDI Parameter Change Table (Current Voice Scene Buffer) table with columns: Address (H), Size (H), Data (H), Parameter Name, Description, Default Value (H), and Range. Lists parameters like Poly Mode, Pitch Up/Down, and various LFO and Sync parameters.



4 - 16bit Step = off  
 5 - Variable Step = always "1"  
 6 - Variable Step = Always Linear / Constant  
 7 - Variable Type = Disposition Over Time; Amp/Vol/Limit  
 8 - Variable Type = Disposition Over Time and in/out buffer

ID	CC	RF	Step Pitch	64..43	40(-0)
10	00..07	WC0 Pitch		-64..-43	40(+0)
11	00..07	WC0 Pitch Depth		-64..-43	40(+0)
12	00..04	WC0 Pitch Source	fixed(0)..fixed(1)..fixed(2)..fixed(3)	0(+0)	0(+0)
13	00..03	WC0 Pitch Mod Source	fixed(0)..fixed(1)..fixed(2)..fixed(3)	0(+0)	0(+0)
14	00..04	WC0 Pitch Level	fixed(0)..fixed(1)..fixed(2)..fixed(3)	0(+0)	0(+0)
15	00..05	WC0 Pitch Source	fixed(0)..fixed(1)..fixed(2)..fixed(3)	0(+0)	0(+0)
16	00..05	WC0 Pitch Source 2	fixed(0)..fixed(1)..fixed(2)..fixed(3)	0(+0)	0(+0)

ID	CC	RF	WC0 Wave	40..04	00..04
17	00..04	WC0 Wave	fixed(0)..fixed(1)..fixed(2)..fixed(3)	40(-0)	00..04
18	00..07	WC0 Pitch Course	fixed(0)..fixed(1)..fixed(2)..fixed(3)	40(-0)	00..07
19	00..02	WC0 Pitch Fine	fixed(0)..fixed(1)..fixed(2)..fixed(3)	-50..-45 cent	00..02
20	00..07	WC0 Edge	fixed(0)..fixed(1)..fixed(2)..fixed(3)	0..-127	00..07
21	00..07	WC0 Pulse Width	fixed(0)..fixed(1)..fixed(2)..fixed(3)	64..-43	40(+0)
22	00..07	WC0 PWM Depth	fixed(0)..fixed(1)..fixed(2)..fixed(3)	-64..-43	40(+0)
23	00..04	WC0 PWM Source	fixed(0)..fixed(1)..fixed(2)..fixed(3)	0..-127	00..04
24	00..07	WC0 Pulse Width	fixed(0)..fixed(1)..fixed(2)..fixed(3)	0..-127	00..07
25	00..07	WC0 PWM Depth	fixed(0)..fixed(1)..fixed(2)..fixed(3)	-64..-43	40(+0)
26	00..04	WC0 PWM Source	fixed(0)..fixed(1)..fixed(2)..fixed(3)	0..-127	00..04

ID	CC	RF	WC0 Pitch Mod Depth	0..-127	00..07
27	01..07	WC0 Pitch Mod Depth <td>fixed(0)..fixed(1)..fixed(2)..fixed(3)</td> <td>0..-127</td> <td>00..07</td>	fixed(0)..fixed(1)..fixed(2)..fixed(3)	0..-127	00..07
28	00..07	WC0 Level <td>fixed(0)..fixed(1)..fixed(2)..fixed(3)</td> <td>0..-127</td> <td>00..07</td>	fixed(0)..fixed(1)..fixed(2)..fixed(3)	0..-127	00..07
29	00..07	WC0 Level <td>fixed(0)..fixed(1)..fixed(2)..fixed(3)</td> <td>0..-127</td> <td>00..07</td>	fixed(0)..fixed(1)..fixed(2)..fixed(3)	0..-127	00..07
30	00..07	WC0 Level <td>fixed(0)..fixed(1)..fixed(2)..fixed(3)</td> <td>0..-127</td> <td>00..07</td>	fixed(0)..fixed(1)..fixed(2)..fixed(3)	0..-127	00..07
31	00..07	WC0 Level <td>fixed(0)..fixed(1)..fixed(2)..fixed(3)</td> <td>0..-127</td> <td>00..07</td>	fixed(0)..fixed(1)..fixed(2)..fixed(3)	0..-127	00..07
32	00..05	WC0 Filter Type <td>fixed(0)..fixed(1)..fixed(2)..fixed(3)</td> <td>0..-127</td> <td>00..05</td>	fixed(0)..fixed(1)..fixed(2)..fixed(3)	0..-127	00..05

### MIDI Data Table <1-5>

Address	Size	Data	Parameter Name	Description	Default
00	00..00	Step Seq Data Unit	Step Seq Data Unit	3..0(0)..1..3(1)	0(0)
01	00..03	Step Seq Group	Step Seq Group	fixed(0)..fixed(1)..fixed(2)..fixed(3)	0(0)
02	00..00	Step Seq Group Type	Step Seq Group Type	fixed(0)..fixed(1)..fixed(2)..fixed(3)	0(0)
03	00..40	Step Seq Ctl Change No	Step Seq Ctl Change No	fixed(0)..-95..AT(6)	00..0(0)
04	00..00	reserved	reserved		00
05	00..00	reserved	reserved		00
06	1..00..07	Step Seq Note No 1	Step Seq Note No 1	C-2(0)..C-6(7)	C1..K7
07	1..00..07	Step Seq Note No 2	Step Seq Note No 2	C-2(0)..C-6(7)	C1..K7
08	1..00..07	Step Seq Note No 3	Step Seq Note No 3	C-2(0)..C-6(7)	C1..K7
09	1..00..07	Step Seq Note No 4	Step Seq Note No 4	C-2(0)..C-6(7)	C1..K7
0A	1..00..07	Step Seq Note No 5	Step Seq Note No 5	C-2(0)..C-6(7)	C1..K7
0B	1..00..07	Step Seq Note No 6	Step Seq Note No 6	C-2(0)..C-6(7)	C1..K7
0C	1..00..07	Step Seq Note No 7	Step Seq Note No 7	C-2(0)..C-6(7)	C1..K7
0D	1..00..07	Step Seq Note No 8	Step Seq Note No 8	C-2(0)..C-6(7)	C1..K7
0E	1..00..07	Step Seq Note No 9	Step Seq Note No 9	C-2(0)..C-6(7)	C1..K7
0F	1..00..07	Step Seq Note No 10	Step Seq Note No 10	C-2(0)..C-6(7)	C1..K7
10	1..00..07	Step Seq Note No 11	Step Seq Note No 11	C-2(0)..C-6(7)	C1..K7
11	1..00..07	Step Seq Note No 12	Step Seq Note No 12	C-2(0)..C-6(7)	C1..K7
12	1..00..07	Step Seq Note No 13	Step Seq Note No 13	C-2(0)..C-6(7)	C1..K7
13	1..00..07	Step Seq Note No 14	Step Seq Note No 14	C-2(0)..C-6(7)	C1..K7
14	1..00..07	Step Seq Note No 15	Step Seq Note No 15	C-2(0)..C-6(7)	C1..K7
15	1..00..07	Step Seq Note No 16	Step Seq Note No 16	C-2(0)..C-6(7)	C1..K7
16	1..00..07	Step Seq Note No 17	Step Seq Note No 17	C-2(0)..C-6(7)	C1..K7
17	1..00..07	Step Seq Note No 18	Step Seq Note No 18	C-2(0)..C-6(7)	C1..K7
18	1..00..07	Step Seq Note No 19	Step Seq Note No 19	C-2(0)..C-6(7)	C1..K7
19	1..00..07	Step Seq Note No 20	Step Seq Note No 20	C-2(0)..C-6(7)	C1..K7
20	1..00..07	Step Seq Note No 21	Step Seq Note No 21	C-2(0)..C-6(7)	C1..K7
21	1..00..07	Step Seq Note No 22	Step Seq Note No 22	C-2(0)..C-6(7)	C1..K7
22	1..00..07	Step Seq Note No 23	Step Seq Note No 23	C-2(0)..C-6(7)	C1..K7
23	1..00..07	Step Seq Note No 24	Step Seq Note No 24	C-2(0)..C-6(7)	C1..K7
24	1..00..07	Step Seq Note No 25	Step Seq Note No 25	C-2(0)..C-6(7)	C1..K7
25	1..00..07	Step Seq Note No 26	Step Seq Note No 26	C-2(0)..C-6(7)	C1..K7
26	1..00..07	Step Seq Note No 27	Step Seq Note No 27	C-2(0)..C-6(7)	C1..K7
27	1..00..07	Step Seq Note No 28	Step Seq Note No 28	C-2(0)..C-6(7)	C1..K7
28	1..00..07	Step Seq Note No 29	Step Seq Note No 29	C-2(0)..C-6(7)	C1..K7
29	1..00..07	Step Seq Note No 30	Step Seq Note No 30	C-2(0)..C-6(7)	C1..K7
30	1..00..07	Step Seq Note No 31	Step Seq Note No 31	C-2(0)..C-6(7)	C1..K7
31	1..00..07	Step Seq Note No 32	Step Seq Note No 32	C-2(0)..C-6(7)	C1..K7
32	1..00..07	Step Seq Note No 33	Step Seq Note No 33	C-2(0)..C-6(7)	C1..K7
33	1..00..07	Step Seq Note No 34	Step Seq Note No 34	C-2(0)..C-6(7)	C1..K7
34	1..00..07	Step Seq Note No 35	Step Seq Note No 35	C-2(0)..C-6(7)	C1..K7
35	1..00..07	Step Seq Note No 36	Step Seq Note No 36	C-2(0)..C-6(7)	C1..K7
36	1..00..07	Step Seq Note No 37	Step Seq Note No 37	C-2(0)..C-6(7)	C1..K7
37	1..00..07	Step Seq Note No 38	Step Seq Note No 38	C-2(0)..C-6(7)	C1..K7
38	1..00..07	Step Seq Note No 39	Step Seq Note No 39	C-2(0)..C-6(7)	C1..K7
39	1..00..07	Step Seq Note No 40	Step Seq Note No 40	C-2(0)..C-6(7)	C1..K7
40	1..00..07	Step Seq Note No 41	Step Seq Note No 41	C-2(0)..C-6(7)	C1..K7
41	1..00..07	Step Seq Note No 42	Step Seq Note No 42	C-2(0)..C-6(7)	C1..K7
42	1..00..07	Step Seq Note No 43	Step Seq Note No 43	C-2(0)..C-6(7)	C1..K7
43	1..00..07	Step Seq Note No 44	Step Seq Note No 44	C-2(0)..C-6(7)	C1..K7
44	1..00..07	Step Seq Note No 45	Step Seq Note No 45	C-2(0)..C-6(7)	C1..K7

### MIDI Parameter Change Table (Use Voice Only Bank Dump)

MIDI Parameter Change Table (Use Voice Only Bank Dump)	Address	Size	Data	Parameter Name	Description	Default
1	00..00	20..07	Voice Name 1	voice name 1	Accl(0)	1
2	00..01	20..07	Voice Name 2	voice name 2	Accl(1)	2
3	00..02	20..07	Voice Name 3	voice name 3	Accl(2)	3
4	00..03	20..07	Voice Name 4	voice name 4	Accl(3)	4
5	00..04	20..07	Voice Name 5	voice name 5	Accl(4)	5
6	00..05	20..07	Voice Name 6	voice name 6	Accl(5)	6
7	00..06	20..07	Voice Name 7	voice name 7	Accl(6)	7
8	00..07	20..07	Voice Name 8	voice name 8	Accl(7)	8
9	00..08	20..07	Voice Name 9	voice name 9	Accl(8)	9
10	00..09	20..07	Voice Name 10	voice name 10	Accl(9)	10

### MIDI Data Table <1-6>

MIDI Data Table <1-6>	Address	Size	Data	Parameter Name	Description	Default
1	00..01	1	Layer Map	Layer Map	Accl(0)	00..0(0)
2	00..02	1	Layer Parameter	Layer Parameter	Accl(1)	00..0(0)
3	00..03	1	Common Tempo	Common Tempo	Accl(2)	00..0(0)
4	00..04	1	Common Split Point	Common Split Point	Accl(3)	00..0(0)
5	00..05	1	Common Parameters Switch	Common Parameters Switch	Accl(4)	00..0(0)
6	00..06	1	Common Ctl1	Common Ctl1	Accl(5)	00..0(0)
7	00..07	1	Common Ctl2	Common Ctl2	Accl(6)	00..0(0)
8	00..08	1	Common Ctl3	Common Ctl3	Accl(7)	00..0(0)
9	00..09	1	Common Ctl4	Common Ctl4	Accl(8)	00..0(0)
10	00..0A	1	Common Ctl5	Common Ctl5	Accl(9)	00..0(0)
11	00..0B	1	Common Ctl6	Common Ctl6	Accl(10)	00..0(0)
12	00..0C	1	Common Ctl7	Common Ctl7	Accl(11)	00..0(0)
13	00..0D	1	Common Ctl8	Common Ctl8	Accl(12)	00..0(0)
14	00..0E	1	Common Ctl9	Common Ctl9	Accl(13)	00..0(0)
15	00..0F	1	Common Ctl10	Common Ctl10	Accl(14)	00..0(0)
16	00..10	1	Common Ctl11	Common Ctl11	Accl(15)	00..0(0)
17	00..11	1	Common Ctl12	Common Ctl12	Accl(16)	00..0(0)
18	00..12	1	Common Ctl13	Common Ctl13	Accl(17)	00..0(0)
19	00..13	1	Common Ctl14	Common Ctl14	Accl(18)	00..0(0)
20	00..14	1	Common Ctl15	Common Ctl15	Accl(19)	00..0(0)
21	00..15	1	Common Ctl16	Common Ctl16	Accl(20)	00..0(0)
22	00..16	1	Common Ctl17	Common Ctl17	Accl(21)	00..0(0)
23	00..17	1	Common Ctl18	Common Ctl18	Accl(22)	00..0(0)
24	00..18	1	Common Ctl19	Common Ctl19	Accl(23)	00..0(0)
25	00..19	1	Common Ctl20	Common Ctl20	Accl(24)	00..0(0)
26	00..1A	1	Common Ctl21	Common Ctl21	Accl(25)	00..0(0)
27	00..1B	1	Common Ctl22	Common Ctl22	Accl(26)	00..0(0)
28	00..1C	1	Common Ctl23	Common Ctl23	Accl(27)	00..0(0)
29	00..1D	1	Common Ctl24	Common Ctl24	Accl(28)	00..0(0)
30	00..1E	1	Common Ctl25	Common Ctl25	Accl(29)	00..0(0)
31	00..1F	1	Common Ctl26	Common Ctl26	Accl(30)	00..0(0)
32	00..20	1	Common Ctl27	Common Ctl27	Accl(31)	00..0(0)
33	00..21	1	Common Ctl28	Common Ctl28	Accl(32)	00..0(0)
34	00..22	1	Common Ctl29	Common Ctl29	Accl(33)	00..0(0)
35	00..23	1	Common Ctl30	Common Ctl30	Accl(34)	00..0(0)
36	00..24	1	Common Ctl31	Common Ctl31	Accl(35)	00..0(0)
37	00..25	1	Common Ctl32	Common Ctl32	Accl(36)	00..0(0)
38	00..26	1	Common Ctl33	Common Ctl33	Accl(37)	00..0(0)
39	00..27	1	Common Ctl34	Common Ctl34	Accl(38)	00..0(0)
40	00..28	1	Common Ctl35	Common Ctl35	Accl(39)	00..0(0)
41	00..29	1	Common Ctl36	Common Ctl36	Accl(40)	00..0(0)
42	00..2A	1	Common Ctl37	Common Ctl37	Accl(41)	00..0(0)
43	00..2B	1	Common Ctl38	Common Ctl38	Accl(42)	00..0(0)
44	00..2C	1	Common Ctl39	Common Ctl39	Accl(43)	00..0(0)
45	00..2D	1	Common Ctl40	Common Ctl40	Accl(44)	00..0(0)

1	00...FF	Reserved	00				
2	00...FF	Wait-ET Param 1 MSB	See Effect Parameter List				
3	00...FF	Wait-ET Param 1 LSB	See Effect Parameter List				
4	00...FF	Wait-ET Param 2 MSB	See Effect Parameter List				
5	00...FF	Wait-ET Param 2 LSB	See Effect Parameter List				
6	00...FF	Wait-ET Param 3 MSB	See Effect Parameter List				
7	00...FF	Wait-ET Param 3 LSB	See Effect Parameter List				
8	00...FF	Wait-ET Param 4 MSB	See Effect Parameter List				
9	00...FF	Wait-ET Param 4 LSB	See Effect Parameter List				
10	00...FF	Wait-ET Param 5 MSB	See Effect Parameter List				
11	00...FF	Wait-ET Param 5 LSB	See Effect Parameter List				
12	00...FF	Wait-ET Param 6 MSB	See Effect Parameter List				
13	00...FF	Wait-ET Param 6 LSB	See Effect Parameter List				
14	00...FF	3-Phase Rq. Low Fireq.	11:14/MSB				
15	00...FF	3-Phase Rq. Low Gain	4:0/MSB				
16	00...FF	3-Phase Rq. Mid Fireq.	2:0/2/MSB				
17	00...FF	3-Phase Rq. Mid Gain	4:0/MSB				
18	00...FF	3-Phase Rq. High Fireq.	0:0/4/MSB				
19	00...FF	3-Phase Rq. High Gain	4:0/MSB				
20	00...FF	3-Phase Rq. Hysteresis	0:0/MSB				
21	00...FF	3-Phase Rq. Filter Time	0:0/MSB				
22	00...FF	3-Phase Rq. LCB	See Effect Parameter List				
23	00...FF	3-Phase Rq. LCB	See Effect Parameter List				
24	00...FF	3-Phase Rq. LCB	See Effect Parameter List				
25	00...FF	3-Phase Rq. LCB	See Effect Parameter List				
26	00...FF	3-Phase Rq. LCB	See Effect Parameter List				
27	00...FF	3-Phase Rq. LCB	See Effect Parameter List				
28	00...FF	3-Phase Rq. LCB	See Effect Parameter List				
29	00...FF	3-Phase Rq. LCB	See Effect Parameter List				
30	00...FF	3-Phase Rq. LCB	See Effect Parameter List				
31	00...FF	3-Phase Rq. LCB	See Effect Parameter List				

32	00...FF	Free B0 7%43 Datal MSB	0:0/157				
33	00...FF	Free B0 7%43 Datal LSB	0:0/157				
34	00...FF	Free B0 7%43 Datal MSB	0:0/157				
35	00...FF	Free B0 7%43 Datal LSB	0:0/157				
36	00...FF	Free B0 7%43 Datal MSB	0:0/157				
37	00...FF	Free B0 7%43 Datal LSB	0:0/157				
38	00...FF	Free B0 7%43 Datal MSB	0:0/157				
39	00...FF	Free B0 7%43 Datal LSB	0:0/157				
40	00...FF	Free B0 7%43 Datal MSB	0:0/157				
41	00...FF	Free B0 7%43 Datal LSB	0:0/157				
42	00...FF	Free B0 7%43 Datal MSB	0:0/157				
43	00...FF	Free B0 7%43 Datal LSB	0:0/157				
44	00...FF	Free B0 7%43 Datal MSB	0:0/157				
45	00...FF	Free B0 7%43 Datal LSB	0:0/157				
46	00...FF	Free B0 7%43 Datal MSB	0:0/157				
47	00...FF	Free B0 7%43 Datal LSB	0:0/157				
48	00...FF	Free B0 7%43 Datal MSB	0:0/157				
49	00...FF	Free B0 7%43 Datal LSB	0:0/157				
50	00...FF	Free B0 7%43 Datal MSB	0:0/157				

1	000124	Ctrl Matrix Param 15	off 0...Vari-EF Dry/Wet 24	*19 00
1	000125	Ctrl Matrix Depth 15	Depends on Ctrl Matrix Param	*19 40 +0
1	000126	Ctrl Matrix Source15	off 0...Assign KnobR(2)	*19 00
1	000127	Ctrl Matrix Param 16	off 0...Vari-EF Dry/Wet 24	*19 00
1	000128	Ctrl Matrix Depth 16	Depends on Ctrl Matrix Param	*19 40 +0

(from Hex - Scene24 Data)

1	000101	Polys Mode	polys0_monor(1) legato 2)	00 polys
1	000104	Push Up - PB Range +	24 (20)...+4.54)	40 +0
1	000106	Push Down - PB Range -	+4 (20)...-4.54	38 0
1	000107	PBD Decay	+4...+43	40 +0
1	000108	PBD Depth	+4...+43 semitones	40 +0
1	000109	PBD Switch	W001.1;W021.0 both 3)	03 both
1	000101	Portamento Mode	normal 0; sustain-key 1	00 normal
1	000101	Portamento Time	fulltime 0; fingers 1	00 normal
1	000101	LFO Rate	0...127	44 (68)
1	000101	LFO Reset Mode	off 0; key-on 1	00 off
1	000104	LFO Wave	sine 00; offset=hz(14)	*13 00 sine
1	000104	LFO Speed	1 0...1256 FF	1F 32)
1	000107	LFO Delay	0...127	00
1	000107	LFO Speed	1 0...1256 FF	57 (88)
1	000101	VCO Algorithm	00; sync-off&PM-on)	00; sync-off&PM-on)
1	000101	VCO Slew w/ FM	SyncoFF&MBoth 1)	00
1	000101	VCO Slew w/ FM	SyncoFF&MBoth 2)	00
1	000101	VCO Slew w/ FM	SyncoFF&MBoth 3)	00
1	000107	Syso Pitch	+4...+43	40 +0
1	000107	Syso Pitch Depth	+4...+43	40 +0
1	000104	Syso Pitch Source	fixed 0; FEG 1; FEG 2; LFO 1; LFO 2 4	00 fixed
1	000103	Syso Pitch Mod Switch	makes 1; value 2 both 3	03 both
1	000104	FM Depth	+4...+43	40 +0
1	000104	FM Source 1	fixed 0; FEG 1; FEG 2; LFO 1; LFO 2 4	00 fixed
1	000106	FM Source 2	W02 1; W02 2; W02 sub 3)	03 W02
1	000103	W01 Rate	saw 0; pulse 1; saw 2; mix 3	00 saw
1	000104	W01 Rate	saw 0; pulse 1; saw 2)	00 saw
1	000107	W01 Pitch Coarse	0...127	40 +0
1	000107	W01 Pitch Fine	+4...+43 semitone	40 +0
1	000107	W01 Edge	0...127	64 (100)
1	000107	W01 Pulse Width	0...127	40 +0
1	000107	W01 PM Depth	+4...+43	40 +0
1	000106	W01 PM Source	fixed 0; FEG 1; FEG 2	00 fixed
1	000107	W01 Pitch Mod Depth	LFO 2; fast 6	00 fast
1	000101	W02 Rate	saw 0; pulse 1; saw 2; mix 3	00 saw
1	000104	W02 Rate	+4...+43 semitone	40 +0
1	000107	W02 Pitch Coarse	+4...+43 semitone	40 +0
1	000107	W02 Pitch Fine	+4...+43 rest 7)	40 +0
1	000107	W02 Edge	0...127	127
1	000107	W02 Pulse Width	0...127	40 +0
1	000107	W02 PM Depth	+4...+43	40 +0
1	000106	W02 PM Source	fixed 0; FEG 1; FEG 2	00 fixed
1	000107	W02 Pitch Mod Depth	LFO 2; fast 6	00 fast
1	000107	Mixer W01 Level	0...127	79
1	000107	Mixer W02 Level	0...127	00
1	000107	Mixer Ring Mod Level	0...127	00
1	000107	Mixer Rise Level	0...127	00
1	000107	FilteredB Attack Time	0...127	00
1	000107	FilteredB Decay Time	0...127	40
1	000107	FilteredB Sustain Level	0...127	79
1	000107	FilteredB Release Time	0...127	55 (85)
1	000107	VCF HRF Cutoff Freq	0...127	00
1	000105	VCF Filter Type	LFF+24B(2) BFF 3	01 LFF+24B

1	000107	Ctrl Matrix Depth 11	Depends on Ctrl Matrix Param	*19 40 +0
1	000121	Ctrl Matrix Source11	off 0...Assign KnobR(2)	*19 00
1	000124	Ctrl Matrix Param 12	off 0...Vari-EF Dry/Wet 24)	*19 00
1	000125	Ctrl Matrix Depth 12	Depends on Ctrl Matrix Param	*19 40 +0
1	000127	Ctrl Matrix Source12	off 0...Assign KnobR(2)	*19 00
1	000124	Ctrl Matrix Param 13	off 0...Vari-EF Dry/Wet 24)	*19 00
1	000127	Ctrl Matrix Depth 13	Depends on Ctrl Matrix Param	*19 40 +0
1	000127	Ctrl Matrix Source13	off 0...Assign KnobR(2)	*19 00
1	000124	Ctrl Matrix Param 14	off 0...Vari-EF Dry/Wet 24)	*19 00
1	000125	Ctrl Matrix Depth 14	Depends on Ctrl Matrix Param	*19 40 +0
1	000127	Ctrl Matrix Source14	off 0...Assign KnobR(2)	*19 00
1	000124	Ctrl Matrix Param 15	off 0...Vari-EF Dry/Wet 24)	*19 00
1	000127	Ctrl Matrix Depth 15	Depends on Ctrl Matrix Param	*19 40 +0
1	000127	Ctrl Matrix Source15	off 0...Assign KnobR(2)	*19 00
1	000124	Ctrl Matrix Param 16	off 0...Vari-EF Dry/Wet 24)	*19 00
1	000124	Ctrl Matrix Param 16	off 0...Vari-EF Dry/Wet 24)	*19 00
1	000124	Ctrl Matrix Depth 16	Depends on Ctrl Matrix Param	*19 40 +0

(from Hex - Step Seq Pattern Data)					
1	000109	Step Seq Base Unit	3 R 0...127 3219)	04 ( 8)	
1	000110	Step Seq Length	1step(1)...15step(10)	0A	
1	000103	Step Seq Loop Type	fwd(0); bckwd(1); alternate(A) 2); alternate(B) 3)	00 fwd	
1	000160	Step Seq Ctrl Change No	off 0...95 AT(60)	00 off	
1	000103	reserved	00	00	
1	000103	reserved	00	00	
1	000107	Step Seq Note No 1	0-2 0...127GR(79)	03 30	
1	000107	Step Seq Note No 2	0-2 0...127GR(79)	03 30	
1	000107	Step Seq Note No 3	0-2 0...127GR(79)	03 30	
1	000107	Step Seq Note No 4	0-2 0...127GR(79)	03 30	
1	000107	Step Seq Note No 5	0-2 0...127GR(79)	03 30	
1	000107	Step Seq Note No 6	0-2 0...127GR(79)	03 30	
1	000107	Step Seq Note No 7	0-2 0...127GR(79)	03 30	
1	000107	Step Seq Note No 8	0-2 0...127GR(79)	03 30	
1	000107	Step Seq Note No 9	0-2 0...127GR(79)	03 30	
1	000107	Step Seq Note No 10	0-2 0...127GR(79)	03 30	
1	000107	Step Seq Note No 11	0-2 0...127GR(79)	03 30	
1	000107	Step Seq Note No 12	0-2 0...127GR(79)	03 30	
1	000107	Step Seq Note No 13	0-2 0...127GR(79)	03 30	
1	000107	Step Seq Note No 14	0-2 0...127GR(79)	03 30	
1	000107	Step Seq Note No 15	0-2 0...127GR(79)	03 30	
1	000107	Step Seq Note No 16	0-2 0...127GR(79)	03 30	
1	000107	Step Seq Velocity 1	rest 0; 1...127	100 64	
1	000107	Step Seq Velocity 2	rest 0; 1...127	100 64	
1	000107	Step Seq Velocity 3	rest 0; 1...127	100 64	
1	000107	Step Seq Velocity 4	rest 0; 1...127	100 64	
1	000107	Step Seq Velocity 5	rest 0; 1...127	100 64	
1	000107	Step Seq Velocity 6	rest 0; 1...127	100 64	
1	000107	Step Seq Velocity 7	rest 0; 1...127	100 64	
1	000107	Step Seq Velocity 8	rest 0; 1...127	100 64	
1	000107	Step Seq Velocity 9	rest 0; 1...127	100 64	
1	000107	Step Seq Velocity 10	rest 0; 1...127	100 64	
1	000107	Step Seq Velocity 11	rest 0; 1...127	100 64	
1	000107	Step Seq Velocity 12	rest 0; 1...127	100 64	
1	000107	Step Seq Velocity 13	rest 0; 1...127	100 64	
1	000107	Step Seq Velocity 14	rest 0; 1...127	100 64	
1	000107	Step Seq Velocity 15	rest 0; 1...127	100 64	
1	000107	Step Seq Velocity 16	rest 0; 1...127	100 64	
1	000107	Step Seq Gate Time 1	1x(0)...120x(40); 120x(200)	94x 32)	
1	000107	Step Seq Gate Time 2	1x(0)...120x(40); 120x(200)	94x 32)	
1	000107	Step Seq Gate Time 3	1x(0)...120x(40); 120x(200)	94x 32)	
1	000107	Step Seq Gate Time 4	1x(0)...120x(40); 120x(200)	94x 32)	
1	000107	Step Seq Gate Time 5	1x(0)...120x(40); 120x(200)	94x 32)	
1	000107	Step Seq Gate Time 6	1x(0)...120x(40); 120x(200)	94x 32)	
1	000107	Step Seq Gate Time 7	1x(0)...120x(40); 120x(200)	94x 32)	
1	000107	Step Seq Gate Time 8	1x(0)...120x(40); 120x(200)	94x 32)	
1	000107	Step Seq Gate Time 9	1x(0)...120x(40); 120x(200)	94x 32)	
1	000107	Step Seq Gate Time 10	1x(0)...120x(40); 120x(200)	94x 32)	
1	000107	Step Seq Gate Time 11	1x(0)...120x(40); 120x(200)	94x 32)	
1	000107	Step Seq Gate Time 12	1x(0)...120x(40); 120x(200)	94x 32)	
1	000107	Step Seq Gate Time 13	1x(0)...120x(40); 120x(200)	94x 32)	
1	000107	Step Seq Gate Time 14	1x(0)...120x(40); 120x(200)	94x 32)	
1	000107	Step Seq Gate Time 15	1x(0)...120x(40); 120x(200)	94x 32)	
1	000107	Step Seq Gate Time 16	1x(0)...120x(40); 120x(200)	94x 32)	
1	000107	Step Seq Ctrl Change Value 1	0...127	0 00	
1	000107	Step Seq Ctrl Change Value 2	0...127	0 00	
1	000107	Step Seq Ctrl Change Value 3	0...127	0 00	
1	000107	Step Seq Ctrl Change Value 4	0...127	0 00	
1	000107	Step Seq Ctrl Change Value 5	0...127	0 00	
1	000107	Step Seq Ctrl Change Value 6	0...127	0 00	
1	000107	Step Seq Ctrl Change Value 7	0...127	0 00	
1	000107	Step Seq Ctrl Change Value 8	0...127	0 00	
1	000107	Step Seq Ctrl Change Value 9	0...127	0 00	
1	000107	Step Seq Ctrl Change Value 10	0...127	0 00	
1	000107	Step Seq Ctrl Change Value 11	0...127	0 00	
1	000107	Step Seq Ctrl Change Value 12	0...127	0 00	
1	000107	Step Seq Ctrl Change Value 13	0...127	0 00	
1	000107	Step Seq Ctrl Change Value 14	0...127	0 00	
1	000107	Step Seq Ctrl Change Value 15	0...127	0 00	
1	000107	Step Seq Ctrl Change Value 16	0...127	0 00	
1	000107	Step Seq Ctrl Change Value 17	0...127	0 00	
1	000107	Step Seq Ctrl Change Value 18	0...127	0 00	
1	000107	Step Seq Ctrl Change Value 19	0...127	0 00	
1	000107	Step Seq Ctrl Change Value 20	0...127	0 00	

- TOTAL SIZE 796
- ms = 00 + TF + User Value 1 + User Value 128
- \*1 see other table (Ctrl Matrix Parameter List)
  - \*2 see other table (Arpeggio Type List)
  - \*3 become available only when Step Seq is selected and Kbd Mode is pm/sl&km or pm/sl&ks&st&shift
  - \*4 only when Arpeggio is selected
  - \*5 only when Step Seq is selected
  - \*6 except \*7
  - \*7 only when Step Seq is selected and Kbd Mode is pm/sl&km or pm/sl&ks&st&shift
  - \*8 become available only when Step Seq is selected
  - \*9 see other table (1st LFO Track Parameter List)
  - \*10 only Bulk Dump not transmitted and received as parameter changes
  - \*11 Poly Mode is poly
  - \*12 Poly Mode is monologate
  - \*13 see other table (LFO Wave Type List)
  - \*14 Oscillator Sync on/off
  - \*15 Oscillator Sync on
  - \*16 Vari H Type is except \*7 \*8
  - \*17 Vari H Type is Aural Exciter, Compressor
  - \*18 Vari H Type is Distortion, Over Drive, Amp Simulator
  - \*19 see other table (Ctrl Matrix Parameter List) and not exist in scene ctrl buffer

**MIDI Parameter Table <1-7>**

MIDI Data Change Table / User Step Seq Pattern - Only Bulk Dump

Address	Size	Data	Parameter Name	Description	Default Value
HR	H	R	H		
01	00	00	01 000109	Step Seq Base Unit	3 R 0...127 3219)
01	00	00	01 000110	Step Seq Length	1step(1)...15step(10)
02	00	00	02 000103	Step Seq Loop Type	fwd(0); bckwd(1); alternate(A) 2); alternate(B) 3)
03	00	00	03 000160	Step Seq Ctrl Change No	off 0...95 AT(60)
04	00	00	04 000103	reserved	00



## ■ ERROR MESSAGE (エラーメッセージ)

The following messages may appear during operation, indicating problems or incorrect operation, or to provide information. These are explained below.

### Battery Low

The memory backup battery is low, and memory cannot be backed up.

### Device No.=off Error

Cannot send MIDI bulk data since the Device Number is set to off.

### Device Number Error

Cannot receive MIDI bulk data due to improper Device Number setting. Match the device numbers for both the AN1x and the external device.

### Not Scene Ctrl

System Exclusive message could not received since the Scene Control function is not activated. Press both Scene switches to activate Scene Control.

### Illegal Data

Error occurred during MIDI data receive. Start the transmit operation once again.

### MIDI Buffer Full!

Too much MIDI information received. Eliminate unnecessary MIDI data.

### SysEx Adrs Error

Received System Exclusive message address is incorrect. Confirm the address of the transmitted data.

### SysEx Data Error

Received System Exclusive message data is incorrect. Confirm the contents of the transmitted data (such as necessary MSB,LSB data, etc.).

### SysEx Size Error

Received System Exclusive message size is incorrect. Confirm the size of the transmitted data.

### Check Sum Error

Received System Exclusive Check Sum message is incorrect. Confirm the Check Sum message of the transmitted data.

### Receiving Bulk

Displays when receiving bulk data.

### Battery Low

本体内のバックアップ（リチウム）バッテリーの電圧が下がった時に表示されます。

### Device No.=off Error

デバイスナンバーがオフになっているため、システムエクスクルーシブメッセージの送信ができなかったことを示しています。

### Device Number Error

デバイスナンバーが一致していないため、システムエクスクルーシブメッセージの受信が出来なかったことを示しています。デバイスナンバーを設定して操作をやり直して下さい。

### Not Scene Ctrl

シーンコントロールが選択されていなかったため、システムエクスクルーシブメッセージの受信出来なかったことを示しています。シーンコントロールスイッチを2つ同時に押し、シーンコントロールを選択して下さい。

### Illegal Data

MIDI 受信中にデータエラーが発生しました。もう一度送信してみてください。

### MIDI Buffer Full!

大量の MIDI 情報を短期間に受信したため、処理出来ませんでした。不要な MIDI 情報はなるべく送らないようにして下さい。

### SysEx Adrs Error

受信したシステムエクスクルーシブメッセージのアドレスが違います。送信データのアドレスを確認して下さい。

### SysEx Data Error

受信したシステムエクスクルーシブメッセージのデータが違います。送信データの内容（MSB、LSB が必要なデータかなど）を確認して下さい。

### SysEx Size Error

受信したシステムエクスクルーシブメッセージのサイズが違います。送信データのサイズを確認して下さい。

### Check Sum Error

受信したシステムエクスクルーシブメッセージのチェックサムが違います。送信データのチェックサムを確認して下さい。

### Receiving Bulk

受信できるフォーマットのバルクデータを受信したとき、表示されます。そのまま操作を続けて下さい。

Function...		Transmitted	Recognized	Remarks
Basic Channel	Default Changed	1 - 16 1 - 16	1 - 16 1 - 16	Memorizd
Mode	Default Messages Altered	3 X *****	3 - 4(m=1) *1 3 - 4(m=1) X	Memorizd
Note Number	: True voice	0 - 127 *****	0 - 127 0 - 127	Transpose
Velocity	Note on Note off	O 9nH,v=1-127 X 9nH,v=0	O v=1-127 O	
After Touch	Key's Ch's	X O	X O	
Pitch Bend		O	O 0-24 semi	
Control Change	0,32 1,4,7,12,13,64 5,10,11,65 6,38 66,67,84 71-74 0-95 91,93,94 96-97 98-99 100-101 120 121	X O X X X O O X X X X X X X	X O O O X O O O O X O O O O	Bank Select  Data Entry  Sound Controller Assignable Control Effect Send Level Data Inc, Dec NRPN LSB,MSB RPN LSB,MSB All Sounds Off Reset All Controls
Program Change	: True number	O 0 - 127 *****	O 0 - 127 0 - 127	
System Exclusive		O	O	
System Common	: Song Position : Song Select : Tune	X X X	X X X	
System Real Time	: Clock : Commands	X X	O O	
Aux Messages	: Local On/Off : All Notes Off : Active Sense : Reset	X X O X	X O ( 123 - 127 ) O X	
Notes : *1: m is always treated as "1" regardless of its value.				

# CONTROL SYNTHESIZER

# AN1x

# PARTS LIST

## ■ CONTENTS (目次)

OVERALL ASSEMBLY (総組立) .....	1
KEYBOARD ASSEMBLY (鍵盤Ass'y) .....	3
ELECTRICAL PARTS (電気部品) .....	5~7

## Note) DESTINATION ABBREVIATIONS

J : Japanese model	A : Australian model
U : U.S.A. model	E : European model
C : Canadian model	D : German model
X : General model	B : British model
M : South African model	I : Indonesian model
H : North European model	O : Chinese model

- The numbers in "QTY" show quantities for each unit.
- The parts with "--" in "Part No." are not available as spare parts.

- 部品価格ランクは、変更になることがあります。
- QTY欄に記されている数字は、各ユニット当たりの使用個数です。
- 部品No.が "--" の部品は、サービス用部品として準備されていません。

## ■ WARNING

Components having special characteristics are marked  and must be replaced with parts having specification equal to those originally installed.

 印の部品は、安全を維持するために重要な部品です。交換する場合は、安全のため必ず指定の部品をご使用下さい。

# OVERALL ASSEMBLY (総組立)

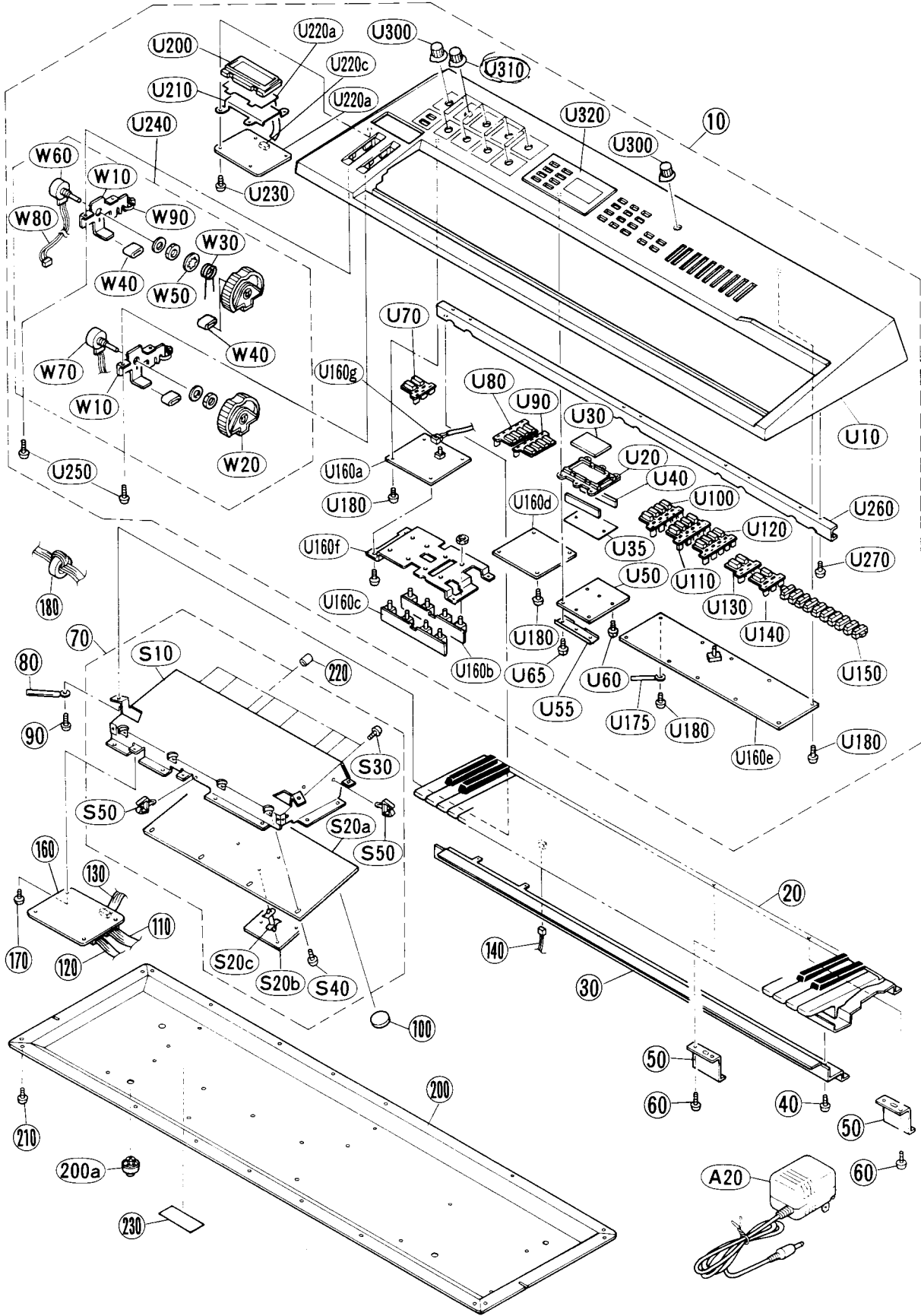



REF NO.	PART NO.	DESCRIPTION	部 品 名	REMARKS	QTY	ランク
10	--	Overall Assembly	総 組 立	AN1x (VV84830)		
20	VN399200	Upper Case Assembly	上 ケー ス A s s ' y	(VV84840)		29
30	VV848600	Keyboard Assembly	L C 鍵盤 A s s ' y			
40	VQ049800	Angle Bracket	M K F ア ン グ ル			
		Bonding Tapping Screw-B	3.0X10 MFZN2BL		4	01
50	VV848700	MKR Angle	M K R ア ン グ ル		2	
60	VQ049800	Bonding Tapping Screw-B	3.0X10 MFZN2BL		8	01
70	--	Shield Box Assembly	シールドボックス A s s y	(VY66390)		
80	CB502030	Cord Binder	S-75B		2	01
90	VQ049800	Bonding Tapping Screw-B	3.0X10 MFZN2BL		2	01
100	VS246400	Lithium Battery	CR2450			03
110	--	Connector Assembly	PH-51004 12P 440L	(VY65580)		
120	--	Connector Assembly	PH11P-5100411P400L	(VY65590)		
130	--	Connector Assembly	6P-150	(VK10060)		
140	--	Connector Assembly	PH-51004 3P 120L	(VY65570)		
160	VV965400	Circuit Board	KBS		4	01
170	EP600190	Bind Head Tapping Screw-B	3.0X8 MFZN2BL			04
180	VC362700	Ferite Core	FR25/15/12-1400L			01
185	CB069250	Cord Holder	BK-1			12
200	VZ236000	Bottom Assembly	ボトム A s s ' y			
200a	VC999400	Foot	205Y4179		4	02
210	VJ254100	Bonding Tapping Screw-B	4.0X10 MFZN2BL		33	01
220	CB825380	Push Button	プッシュボタン	POWER switch		03
230	--	Name Plate	銘 板	(VY66400)		
A20	VT368600	Accessory	付 属 品			09
A20	VT368700	AC Adaptor	A C ア ダ プ タ ー	J		08
A20	VT368800	AC Adaptor	A C ア ダ プ タ ー	E		
U10	--	Upper Case Assembly	上 ケー ス A s s ' y	AN1x (VV84840)		
U20	VU540300	Upper Case	上 ケー ス 塗 装 印 刷 品			05
U30	VV290800	Lens, Back-lit	バックライトレンズ			
U35	VU673400	LCD	LCD5857H			03
U40	VS555800	Reflection Sheet	リフレクトシート			
U40	VS555800	Rubber Connector	SG		2	02
U50	VV965100	Circuit Board	LC			
U55	VV170400	Spacer	L C シ ー ト			
U60	EP600280	Bind Head Tapping Screw-P	3.0X8 MFZN2Y		3	01
U65	EP630660	Bind Head Tapping Screw-P	3.0X10 MFZN2Y		3	
U70	VY664100	Key Top	キー トップ L G 印 刷 品			
U80	VY664200	Key Top	キー トップ S C 印 刷 品			
U90	VY664300	Key Top	キー トップ P G 印 刷 品			
U100	VU640300	Key Top	キー トップ T 1 印 刷 品			05
U110	VU640400	Key Top	キー トップ T 2 印 刷 品			05
U120	VY664400	Key Top	キー トップ T + 印 刷 品			
U130	VU590900	Key Top Rubber	L2			03
U140	VZ179900	Key Top Rubber	AN			03
U150	VU643100	Key Top Rubber	P10			06
U160	--	PN Circuit Board Assembly	PN シ ー ト A s s ' y	(VY66450)		
U160a	NX818740	Circuit Board	PN 1/5			
U160b	NX818750	Circuit Board	PN 2/5			
U160c	NX818760	Circuit Board	PN 3/5			
U160d	NX818770	Circuit Board	PN 4/5			
U160e	NX818780	Circuit Board	PN 5/5			
U160f	VV849000	Angle Bracket, Panel	P N ア ン グ ル			
U160g	--	Connector Assembly	M V R 束 線	(VY68100)		
U175	CB502030	Cord Binder	S-75B		2	
U180	EP600280	Bind Head Tapping Screw-P	3.0X8 MFZN2Y		18	01
U200	VV941800	RBN Escussion	RBN ESC成形上り品			
U210	VV941900	RBN Angle	R B N ア ン グ ル			
U220	--	RBN Assembly	R B N A s s ' y	(VY66460)		
U220a	VY687100	Ribbon Sensor	X:10K Z:2K			
U220b	VV965300	Circuit Board	RBN			
U220c	--	Connector Assembly	7P-300	(VK10580)		
U230	EP600280	Bind Head Tapping Screw-P	3.0X8 MFZN2Y		4	01
U240	--	Wheel Assembly	ホイール A s s ' y	(VU64090)		
U250	EP600280	Bind Head Tapping Screw-P	3.0X8 MFZN2Y		4	01
U260	VV848800	MKU Angle	M K U ア ン グ ル			
U270	EP600280	Bind Head Tapping Screw-P	3.0X8 MFZN2Y		8	01

\* New Parts (新規部品)

ランク : Japan only

REF NO.	PART NO.	DESCRIPTION	部 品 名	REMARKS	QTY	ランク
U300	VU540400	Knob	ロ ー タ リ ー ツ マ ミ	VOLUME,Dial	2	03
U310	VV972300	Knob	ロ ー タ リ ー ツ マ ミ	ASSIGN 1-8	8	
U320	VY664700	LCD Cover	L C D カ バ ー			
	--	Shield Box Assembly	シールドボックス A s s y	(VY66390)		
S10	VV848900	Shield Box	シールドボックス			
S20	--	DM Circuit Board Assembly	DM シ ー ト A s s ' y	(VY66480)		
S20a	VV016400	Circuit Board	D M シ ー ト			
S20b	VV234900	Circuit Board	D M S シ ー ト			
S20c	VS262100	Support, PCB	基 板 サ ポ ー ト		2	01
S30	VQ049800	Bonding Tapping Screw-B	3.0X10 MFZN2BL		7	01
S40	EP600190	Bind Head Tapping Screw-B	3.0X8 MFZN2BL		4	01
S50	VR641100	Cord Holder	UAMS-09-0		2	01
	--	Wheel Assembly	ホイール A s s ' y	(VU64090)		
W10	VQ561400	Frame	M		2	04
W20	VF537400	Wheel	フ レ ー ム		2	03
W30	VC792800	Spring	ホ イ ー ル	PITCH,MODULATION	2	01
W40	CB819020	Wheel Tube	リ タ ー ン S P			
W50	EW600110	Stop Ring	ホ イ ー ル チ ュ ー プ		3	04
W60	VQ764300	Rotary Variable Resistor	12.0			01
W70	VN245400	Rotary Variable Resistor	10K RK1631110T54A	ロ ー タ リ ー V R		03
W80	--	Connector Assembly	10.0K K161100S	ロ ー タ リ ー V R		03
W90	CB069250	Cord Holder	PH5P-5F 300L+100L BK-1	W H E E L 束 線	(VU55440)	
				インシュロックタイ	2	01

\* New Parts (新規部品)

ランク : Japan only

KEYBOARD ASSEMBLY (鍵盤Ass'y)

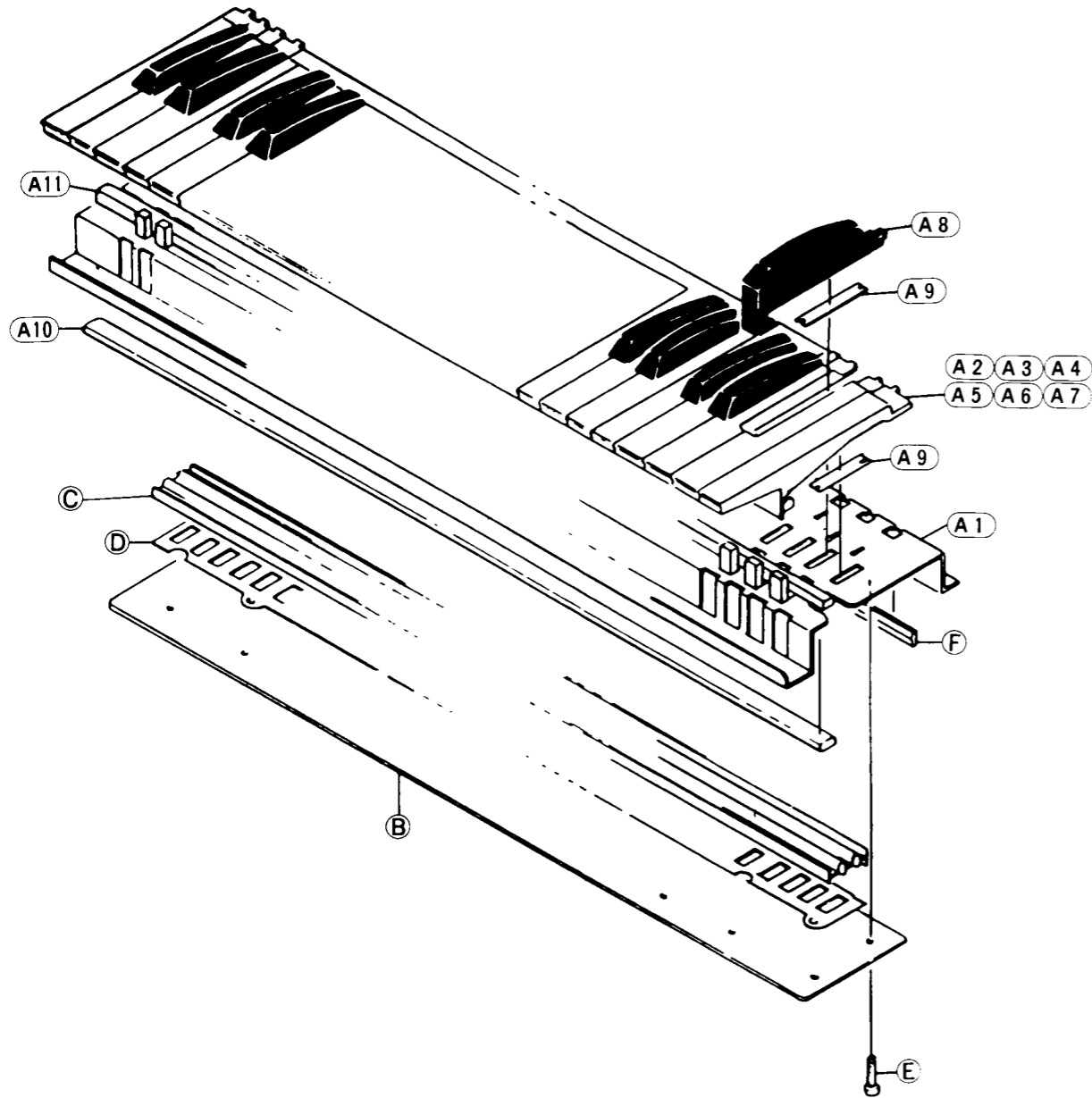

REF NO.	PART NO.	DESCRIPTION	部 品 名	REMARKS	QTY	ラック
	VN399200	Keyboard Assembly	C61 K6	LC 鍵盤 Ass'y	AN1x	29
A	--	MK Frame Assembly		MK フレーム Ass'y	(VN40550)	
B	V1912000	Circuit Board	MK	M K シ ー ト		14
C	VF834100	Rubber Contact		可 動 導 電 ゴ ム		09
D	VM630100	Insulation Spacer		絶 縁 ス ペ ー サ ー		06
E	EP630630	Bind Head Tapping Screw-S	3.0X10 MFZN2Y	+ バ イ ン ド ス タ イ ト		16
F	VC079800	Stopper		ス ト ッ パ ー		02
A1	--	MK Frame Assembly		M K フ レ ー ム Ass'y	(VN40550)	
	--	MK Frame		M K フ レ ー ム	(VM63000)	
A2	VL570000	White Key	CF	白 鍵		10
A3	VL570100	White Key	D	白 鍵		5
A4	VL570200	White Key	BE	白 鍵		10
A5	VL570300	White Key	G	白 鍵		5
A6	VL570400	White Key	A	白 鍵		5
A7	VL570500	White Key	C'	白 鍵		03
A8	VL570600	Black Key		黒 鍵		25
A9	VC077600	Spring		バ ン ス プ リ ン グ		61
A10	VR857100	Felt	820X6X3.6	フ ェ ル ト		03
A11	VN406100	PC Sensor	MK-LC61TO-N	PC セ ン サ ー		10

\* New Parts (新規部品)

ラック : Japan only

ELECTRICAL PARTS (電気部品)

REF NO.	PART NO.	DESCRIPTION	部 品 名	REMARKS	QTY	ラック
*	VV016400	Circuit Board	DM	D M シ ー ト	AN1x	
*	VV234900	Circuit Board	DMS	D M S シ ー ト		
*	VV965100	Circuit Board	LC	L C シ ー ト		
*	VV965200	Circuit Board	LE	L E シ ー ト		
*	V1912000	Circuit Board	MK	M K シ ー ト		14
*	VV271900	Circuit Board	PN	P N シ ー ト		
*	NX818740	Circuit Board	PN 1/5	P N シ ー ト ( 1 / 5 )		
*	NX818750	Circuit Board	PN 2/5	P N シ ー ト ( 2 / 5 )		
*	NX818760	Circuit Board	PN 3/5	P N シ ー ト ( 3 / 5 )		
*	NX818770	Circuit Board	PN 4/5	P N シ ー ト ( 4 / 5 )		
*	NX818780	Circuit Board	PN 5/5	P N シ ー ト ( 5 / 5 )		
*	VV965400	Circuit Board	KBS	K B S シ ー ト		
*	VV965300	Circuit Board	RBN	R B N シ ー ト		
*	VV016400	Circuit Board	DM	D M シ ー ト	(XS281B0)	
	UB012390	Monolithic Ceramic Cap.	B 390P 50V K	チ ッ プ 積 層 セ ラ コ ン		01
	UB012680	Monolithic Ceramic Cap.	B 680P 50V K	チ ッ プ 積 層 セ ラ コ ン		01
	UB012820	Monolithic Ceramic Cap.	B 820P 50V K	チ ッ プ 積 層 セ ラ コ ン		01
	UB013100	Monolithic Ceramic Cap.	B 1000P 50V K	チ ッ プ 積 層 セ ラ コ ン		01
	UB013220	Monolithic Ceramic Cap.	B 2200P 50V K	チ ッ プ 積 層 セ ラ コ ン		01
	UB013680	Monolithic Ceramic Cap.	B 6800P 50V K	チ ッ プ 積 層 セ ラ コ ン		01
	UB051220	Monolithic Ceramic Cap.	SL 22P 50V J	チ ッ プ 積 層 セ ラ コ ン		01
	UB051470	Monolithic Ceramic Cap.	SL 47P 50V J	チ ッ プ 積 層 セ ラ コ ン		01
	UB052100	Monolithic Ceramic Cap.	SL 100P 50V J	チ ッ プ 積 層 セ ラ コ ン		01
	UB044100	Monolithic Ceramic Cap.	F 0.010 50V Z	チ ッ プ 積 層 セ ラ コ ン		01
	UB245100	Monolithic Ceramic Cap.	F 0.100 25V Z	チ ッ プ 積 層 セ ラ コ ン		01
	VJ927300	Monolithic Ceramic Cap.	1.500 16V F	チ ッ プ 積 層 セ ラ コ ン		01
	UI537100	Electrolytic Cap.	10.00 16.0V	ケ ミ コ ン		01
	UI537220	Electrolytic Cap.	22.00 16.0V	ケ ミ コ ン		01
	UI566100	Electrolytic Cap.	1.00 50.0V	ケ ミ コ ン		01
	UJ837100	Electrolytic Cap.	10.00 16.0V	ケ ミ コ ン		01
	UJ837470	Electrolytic Cap.	47.00 16.0V	ケ ミ コ ン		01
	UJ838100	Electrolytic Cap.	100.00 16.0V	ケ ミ コ ン		01
	UJ838220	Electrolytic Cap.	220.00 16.0V	ケ ミ コ ン		01
	UJ866100	Electrolytic Cap.	1.00 50.0V	ケ ミ コ ン		01
	UJ866330	Electrolytic Cap.	3.30 50.0V	ケ ミ コ ン		01
	UJ866470	Electrolytic Cap.	4.70 50.0V	ケ ミ コ ン		01
	VH340400	Electrolytic Cap.	330.00 25.0V	ケ ミ コ ン R S		01
	VH340500	Electrolytic Cap.	470.00 25.0V	ケ ミ コ ン R S		01
	UN837100	Electrolytic Cap.-BP	10.00 16.0V	B P ケ ミ コ ン		01
	V8835000	Coil	FL5R200QNT	コ イ ル 2 0 U		01
	VL409500	Coil	BL03RN2-R62T4	コ イ ル 0 . 4 5 U		01
	VR579900	Chip Inductance	BK2125HS601-T	チ ッ プ イ ン ダ ク タ		01
	RD154470	Carbon Resistor (chip)	47.0 1/4 J	チ ッ プ 抵 抗		
	RD154560	Carbon Resistor (chip)	56.0 1/4 J	チ ッ プ 抵 抗		
	RD155470	Carbon Resistor (chip)	470.0 1/4 J	チ ッ プ 抵 抗		01
	RD250000	Carbon Resistor (chip)	0.0 0.0 J	チ ッ プ 抵 抗		01
	RD254100	Carbon Resistor (chip)	10.0 0.1 J	チ ッ プ 抵 抗		01
	RD254470	Carbon Resistor (chip)	47.0 0.1 J	チ ッ プ 抵 抗		01
	RD254680	Carbon Resistor (chip)	68.0 0.1 J	チ ッ プ 抵 抗		01
	RD254820	Carbon Resistor (chip)	82.0 0.1 J	チ ッ プ 抵 抗		01
	RD255100	Carbon Resistor (chip)	100.0 0.1 J	チ ッ プ 抵 抗		01
	RD255150	Carbon Resistor (chip)	150.0 0.1 J	チ ッ プ 抵 抗		01
	RD255220	Carbon Resistor (chip)	220.0 0.1 J	チ ッ プ 抵 抗		01
	RD255470	Carbon Resistor (chip)	470.0 0.1 J	チ ッ プ 抵 抗		01
	RD256100	Carbon Resistor (chip)	1.0K 0.1 J	チ ッ プ 抵 抗		01
	RD256150	Carbon Resistor (chip)	1.5K 0.1 J	チ ッ プ 抵 抗		01
	RD256270	Carbon Resistor (chip)	2.7K 0.1 J	チ ッ プ 抵 抗		01
	RD256470	Carbon Resistor (chip)	4.7K 0.1 J	チ ッ プ 抵 抗		01
	RD256680	Carbon Resistor (chip)	6.8K 0.1 J	チ ッ プ 抵 抗		01
	RD257100	Carbon Resistor (chip)	10.0K 0.1 J	チ ッ プ 抵 抗		01
	RD257120	Carbon Resistor (chip)	12.0K 0.1 J	チ ッ プ 抵 抗		01
	RD257150	Carbon Resistor (chip)	15.0K 0.1 J	チ ッ プ 抵 抗		01
	RD257200	Carbon Resistor (chip)	20.0K 0.1 J	チ ッ プ 抵 抗		01
	RD257220	Carbon Resistor (chip)	22.0K 0.1 J	チ ッ プ 抵 抗		01
	RD257470	Carbon Resistor (chip)	47.0K 0.1 J	チ ッ プ 抵 抗		01
	RD258100	Carbon Resistor (chip)	100.0K 0.1 J	チ ッ プ 抵 抗		01
	VI197400	Carbon Resistor (chip)	10.0K 1/10 D	チ ッ プ 金 被 抵 抗		01
	RD259100	Carbon Resistor (chip)	1.0M 0.1 J	チ ッ プ 抵 抗		01
	RE044680	Resistor Array	68X4	抵 抗 ア レ イ		01

\* New Parts (新規部品)

ラック : Japan only

REF NO.	PART NO.	DESCRIPTION	部 品 名	REMARKS	QTY	ラック
	RE045100	Resistor Array	100X4	抵 抗 ア レ イ		01
	RE045470	Resistor Array	470X4	抵 抗 ア レ イ		01
	RE047100	Resistor Array	10KX4	抵 抗 ア レ イ		01
	RE047470	Resistor Array	47KX4	抵 抗 ア レ イ		01
	XF291A00	IC	UPC4570G2		OP AMP	03
	XQ138A00	IC	NJM4556AMT1		C OP AMP	03
	XJ598A00	IC	NJM78L05UA		C REGULATOR +5	02
	XM968B00	IC	UPC24M09AHF		C REGULATOR -9V	03
	XS346A00	IC	SI-8501L		C REGULATOR +5V	07
	XD657A00	IC	TC74HC14AF-TP1		C INVERTER	02
	XD838A00	IC	SN74HC245NSR		C BUFFER	04
	XM588A00	IC	TC7S32F		C OR	01
	XP231A00	IC	TC74AC139F		C DECODER	02
	XR011A00	IC	TC74HC595AF		C SHIFT REGISTER	04
	XR150A00	IC	TC74HC4053AF		C ANALOG SW	03
*	XT163A00	IC	TC74HC238AF		C LINE DECODER	
	XQ375A00	IC	HD6413002FP16		C CPU	09
*	XP309B00	IC	HM628128BLFP-8		C SRAM 1M	
	XR024A00	IC	LC321664AJ-80		C DRAM 1M	10
*	XT113B00	IC	LH531024-		C EPROM 1M	
*	XS467B00	IC	282AV100		C ROM 8M (MAIN)	
	XI686A00	IC	M62021FP		C RESET	04
	XM309A00	IC	HD62098		C MULTI EFFECT GENERATOR	12
	XP867A00	IC	UPD63200GS-E1		C DA CONVERTER	07
*	XT013A00	IC	YSS236-F		C VOP3	
	VP691000	Push Switch	SDDL1	プ ッ シ ュ S W	POWER switch	03
	VB966900	Style Pin	IMS-A-6024	ス タ イ ル ピ ン L=3.5		01
	VE382300	Phone Jack	YKB21-5010	ホ ー ン コ ネ ク タ	PHONES	01
	VJ207400	DC-IN Connector	16V DC 3A HEC2305	D C ジャ ッ ク	DC IN	01
	VS115400	Phone Jack	LGR4609-7000	ホ ー ン コ ネ ク タ (黒)	OUT L/R, FOOT VOL/CONT/SW	01
	VJ885500	DIN Connector	3P YKF51-5054	D I N コ ネ ク タ	MIDI OUT/THRU	04
	VT033600	DIN Connector	3P YKF51-5067	D I N コ ネ ク タ	MIDI IN	03
	VB389900	Connector Base Post	PH- 3P TE	コ ネ ク タ ベ ー ス ポ ス ト		01
	VB390100	Connector Base Post	PH- 5P TE	コ ネ ク タ ベ ー ス ポ ス ト		01
	VB390200	Connector Base Post	PH- 6P TE	コ ネ ク タ ベ ー ス ポ ス ト		01
	VB390300	Connector Base Post	PH- 7P TE	コ ネ ク タ ベ ー ス ポ ス ト		01
	VB390400	Connector Base Post	PH- 8P TE	コ ネ ク タ ベ ー ス ポ ス ト		01
	VE352600	Connector Base Post	PH-14P TE	コ ネ ク タ ベ ー ス ポ ス ト		01
	VF283100	Connector Base Post	PH-13P TE	コ ネ ク タ ベ ー ス ポ ス ト		01
	VF283300	Connector Base Post	PH-15P TE	コ ネ ク タ ベ ー ス ポ ス ト		01
	VN242700	Connector	FX2 52P TE	F X 2 コ ネ ク タ		04
	VK863100	IC Socket	DICF-42CS-E	I C ソ ケ ッ ト		03
	VS246300	Battery Holder	CR2450BH	バ ッ テ リ ー ホ ル ダ ー		03
	VD542700	LC Filter	DSS306-93F223Z1	L C フ ィ ル タ ー		01
	VG238200	LC Filter	PLT2003C	L C フ ィ ル タ ー E M I		04
	VP864800	Quartz Crystal Unit	11.2896M SMD-49	水 晶 振 動 子		04
	VP864900	Quartz Crystal Unit	16M SMD-49	水 晶 振 動 子		04
	VJ927200	Transistor	2SA1162 O.Y	ト ラ ン ジ ス タ		01
	VD303700	Transistor	2SC3326 A,B TE85R	ト ラ ン ジ ス タ		01
	VM810300	Transistor Array	HN1A01F-Y/GR(TE85R)	ト ラ ン ジ ス タ ア レ イ		01
	VS056500	Transistor Array	HN1C01F-Y/GR(TE85R)	ト ラ ン ジ ス タ ア レ イ		01
	VB797600	Diode	RLS-73	ダ イ オ ー ド		01
	VQ282500	Diode	MA737	ダ イ オ ー ド		02
	VS201100	Diode	D1F60	ダ イ オ ー ド		01
	VU171500	Zener Diode	UDZ 3.6BTE-17 3.6V	ツ ェ ナ ー ダ イ オ ー ド		01
	VU540600	Holder, Jack		J K ア ン グ ル		05
IC1	VN686000	Photo Coupler	PC410T	フ ォ ト カ プ ラ		04
IC1	VR903700	Photo Coupler	HCPL-M600	フ ォ ト カ プ ラ		04
*	VV234900	Circuit Board	DMS	D M S シ ー ト	(XS316B0)	
	UB044100	Monolithic Ceramic Cap.	F 0.010 50V Z	チ ッ プ 積 層 セ ラ コ ン		01
	UB245100	Monolithic Ceramic Cap.	F 0.100 25V Z	チ ッ プ 積 層 セ ラ コ ン		01
	U1537100	Electrolytic Cap.	10.00 16.0V	ケ ミ コ ン		01
	U1537220	Electrolytic Cap.	22.00 16.0V	ケ ミ コ ン		01
	VB835000	Coil	FL5R200QNT	コ イ ル 2 0 U		01
	RD250000	Carbon Resistor (chip)	0.0 0.0 J	チ ッ プ 抵 抗		01
	RD255100	Carbon Resistor (chip)	100.0 0.1 J	チ ッ プ 抵 抗		01
	RD256100	Carbon Resistor (chip)	1.0K 0.1 J	チ ッ プ 抵 抗		01
	RD256680	Carbon Resistor (chip)	6.8K 0.1 J	チ ッ プ 抵 抗		01
*	XT113B00	IC	LH531024-		DRAM 1M	

\* New Parts (新規部品)

ラック : Japan only

REF NO.	PART NO.	DESCRIPTION	部 品 名	REMARKS	QTY	ランク
*	XT013A00	IC	YSS236-F	I C		
*	VS947400	Connector	FX2 52P TE	F X 2 コ ネ ク タ		
*	VV965100	Circuit Board	LC	L C シ ー ト	(XS468B0)	
*	VV965200	Circuit Board	LE	L E シ ー ト	(XS468B0)	
	VD930900	Semiconductive Cera. Cap.	0.1000 25V M	半 導 体 セ ラ コ ン		01
	HF455330	Carbon Resistor	330.0 1/4 J	カ ー ボ ン 抵 抗		01
	HF457100	Carbon Resistor	10.0K 1/4 J	カ ー ボ ン 抵 抗		01
	HF457910	Carbon Resistor	91.0K 1/4 J	カ ー ボ ン 抵 抗		01
	VR538200	Resistor Array	EXBF6N102J	抵 抗 モ ジ ュ ー ル		01
	XN859A00	IC	LC7985ND	I C	LCD CONTROLLER	06
	VU619100	Pin Header	A4B-5PA-2DS	ピ ン ヘ ッ ダ ー		01
	VU767400	LED	GL1EG211 GR	L E D	LCD back-lit	01
	--	Connector Assembly	15P-400	D S - K R 束 線	(VV97440)	
	V1912000	Circuit Board	MK	M K シ ー ト	(XH247G0)	14
	UJ827470	Electrolytic Cap.	47.00 10.0V	ケ ミ コ ン		01
	VC694800	Semiconductive Cera. Cap.	0.1000 25V Z	半 導 体 セ ラ コ ン		01
	HF755150	Carbon Resistor	150.0 1/4 J	カ ー ボ ン 抵 抗		01
	HF756100	Carbon Resistor	1.0K 1/4 J	カ ー ボ ン 抵 抗		01
	HF756220	Carbon Resistor	2.2K 1/4 J	カ ー ボ ン 抵 抗		01
	HF756680	Carbon Resistor	6.8K 1/4 J	カ ー ボ ン 抵 抗		01
	HF757470	Carbon Resistor	47.0K 1/4 J	カ ー ボ ン 抵 抗		03
	IG001390	IC	RC4558D-V	I C	OPAMP	01
	LB016030	Connector	FFC-3P TE	コ ネ ク タ		03
	VE387000	Base Post Connector	53014-3P TE	ベ ー ス ポ ス ト		01
	VE387800	Base Post Connector	53014-11P TE	ベ ー ス ポ ス ト		01
	VE387900	Base Post Connector	53014-12P TE	ベ ー ス ポ ス ト	(VQ35910)	01
	--	Adhesive Tape	24MM 330M	粘 着 テ ー プ		02
	HT370260	Trimmer Potentiometer	B 100.0K 3P EVN	半 固 定 V R		02
	HT370280	Trimmer Potentiometer	B 500.0K 3P EVN	半 固 定 V R		01
	VB941200	Diode	1SS133,1SS176	ダ イ オ ー ド		
	VA078900	Jumper Wire	0.55	ジ ャ ン パ ー 線		
*	NX818740	Circuit Board	PN 1/5	P N シ ー ト ( 1 / 5 )	(XS249B0)	
*	NX818750	Circuit Board	PN 2/5	P N シ ー ト ( 2 / 5 )	(XS249B0)	
*	NX818760	Circuit Board	PN 3/5	P N シ ー ト ( 3 / 5 )	(XS249B0)	
*	NX818770	Circuit Board	PN 4/5	P N シ ー ト ( 4 / 5 )	(XS249B0)	
*	NX818780	Circuit Board	PN 5/5	P N シ ー ト ( 5 / 5 )	(XS249B0)	
*	VU411100	Rotary Switch	SRBV16036A	ロ ー タ リ ー S W	Dial	04
	VV056000	Tact Switch	SKQNAE025A	タ ク ト S W		01
	VB858400	Connector Base Post	PH- 5P SE	コ ネ ク タ ベ ー ス ポ ス ト		01
	VB858500	Connector Base Post	PH- 6P SE	コ ネ ク タ ベ ー ス ポ ス ト		01
	VB858800	Connector Base Post	PH- 9P SE	コ ネ ク タ ベ ー ス ポ ス ト		01
*	VV973400	Rotary Variable Resistor	B10.0K RK0971114	ロ ー タ リ ー V R ( S 付 )	ASSIGN 1-8	
	VT683300	Rotary Variable Resistor	A 30.0K RK14K12C	二 連 ロ ー タ リ ー V R	VOLUME	03
	VD631600	Diode	1SS133,176,HSS104	ダ イ オ ー ド		01
	VS704700	LED	SEL2210W TP8	L E D	SCENE(1,2),SYNC/FM, PEG/LFO,VCO1,VCO2,VCF, MIX/VCF,VCA,ASSIGN	01
	VA078900	Jumper Wire	0.55	ジ ャ ン パ ー 線		
	--	Connector Assembly	13P-160	D S - D S 束 線	(VU40610)	
	--	Connector Assembly	12P-160	D S - D S 束 線	(VV97400)	
	--	Connector Assembly	8P-300	D S - K R 束 線	(VV97410)	
	--	Connector Assembly	13P-250	D S - K R 束 線	(VV97420)	
	--	Connector Assembly	14P-260	D S - K R 束 線	(VV97430)	
	--	GND Wire A	50L	A ー ス 線 A	(YY98430)	
	--	Connector Assembly	5P-220	D S - K R 束 線	(YY98880)	
	--	Connector Assembly	9P-160	D S - K R 束 線	(YY98890)	
*	VV965200	Circuit Board	LE	L E シ ー ト	(XS468B0)	
*	VV965400	Circuit Board	KBS	K B S シ ー ト	(XS469B0)	
*	VV965300	Circuit Board	RBN	R B N シ ー ト	(XS469B0)	
	UJ837100	Electrolytic Cap.	10.00 16.0V	ケ ミ コ ン		01
	UJ837470	Electrolytic Cap.	47.00 16.0V	ケ ミ コ ン		01
	VD930900	Semiconductive Cera. Cap.	0.1000 25V M	半 導 体 セ ラ コ ン		01
	HF455100	Carbon Resistor	100.0 1/4 J	カ ー ボ ン 抵 抗		01
	HF455150	Carbon Resistor	150.0 1/4 J	カ ー ボ ン 抵 抗		01
	HF456100	Carbon Resistor	1.0K 1/4 J	カ ー ボ ン 抵 抗		01
	HF456220	Carbon Resistor	2.2K 1/4 J	カ ー ボ ン 抵 抗		01

ランク : Japan only

\* New Parts (新規部品)

REF NO.	PART NO.	DESCRIPTION	部 品 名	REMARKS	QTY	ランク
	HF456680	Carbon Resistor	6.8K 1/4 J	カ ー ボ ン 抵 抗		01
	HF457100	Carbon Resistor	10.0K 1/4 J	カ ー ボ ン 抵 抗		01
	HF457270	Carbon Resistor	27.0K 1/4 J	カ ー ボ ン 抵 抗		01
	HF458100	Carbon Resistor	100.0K 1/4 J	カ ー ボ ン 抵 抗		01
	VL674500	Resistor Array	RGLE12X223J	抵 抗 ア レ イ		01
	IG001390	IC	RC4558D-V	！	C	03
	XN668A00	IC	HD63B05V0E65F	！	C	06
	VB389600	Connector Base Post	PH-11P SE	コ ネ ク タ ベ ー ス ポ ス ト	OPAMP	01
	VB390300	Connector Base Post	PH- 7P TE	コ ネ ク タ ベ ー ス ポ ス ト	PKS	01
	VB858500	Connector Base Post	PH- 6P SE	コ ネ ク タ ベ ー ス ポ ス ト		01
	VC166500	Connector Base Post	PH-12P SE	コ ネ ク タ ベ ー ス ポ ス ト		01
*	VY997800	FFC Connector	10P SE	F F C コ ネ ク タ		02
	VH902200	Ceramic Resonator	CST8.00MTW140-TF01	セ ラ ミ ッ ク 振 動 子		01
	VZ047300	Trimmer Potentiometer	B 500.0K 3P EVN	半 固 定 V R		01
	VB593200	Trimmer Potentiometer	B 100.0K 3P EVN	半 固 定 V R		01
	VD631600	Diode	1SS133,176,HSS104	ダ イ オ ー ド		01
	VA078900	Jumper Wire	0.55	ジ ャ ン パ ー 線		
	--	GND Wire B	60-60L	ア ー ス 線 B	(VY99040)	
	VS246400	Lithium Battery	CR2450	リ チ ウ ム 電 池		03
*	VY290800	LCD	LCD5857H	カ ス タ ム 液 晶 デ ィ ス プ レ イ		
*	VY687100	Ribbon Sensor	X:10K Z:2K	リ ボ ン セ ン サ ー		
	VQ764300	Rotary Variable Resistor	10K RK1631110T54A	ロ ー タ リ ー V R	PITCH	03
	VN245400	Rotary Variable Resistor	10.0K K161100S	ロ ー タ リ ー V R	MODULATION	03

\* New Parts (新規部品)

ランク : Japan only