



Prophecy

SOLO SYNTHESIZER

Players / Basic Guide



Multi Oscillator Synthesis System

KORG

® ①

Prophecy

SOLO SYNTHESIZER

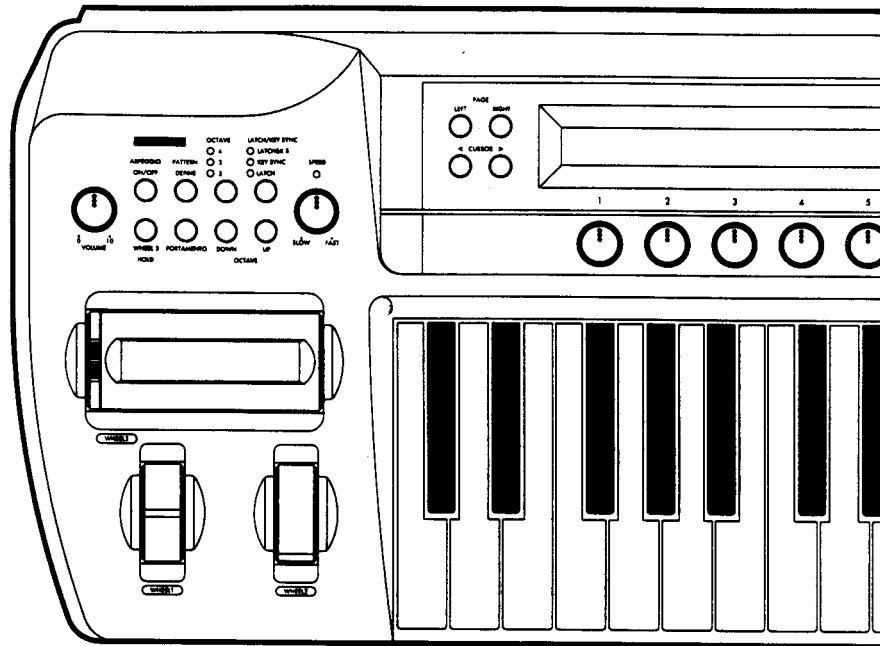

Main features of the Prophecy

1 The Prophecy is a 37 note monophonic synthesizer featuring a newly developed system of tone generation; **MOSS (Multi Oscillator Synthesis System)**.

Seven different synthesis techniques are supported, ranging from analog synthesizer oscillators to physical models such as sax or bass guitar. The Prophecy provides an unprecedented degree of expressiveness.

2 Bank A and bank B each provide 64 programs (a total of 128). Programs that you edit can also be stored in these banks. An optional SRC-512 RAM memory card can be used to store an additional 64 programs for instant access.

3 Keyboard dynamics, wheel controllers 1/2/3, the ribbon controller, and an optional foot pedal can be used for realtime control of filter cutoff, resonance, and effect parameters, etc. for heightened performance expression. These settings are memorized for each program, allowing you to select performance techniques as appropriate for your style and the selected sound.

4 The Performance Editor function lets you assign parameters to each of the five knobs for realtime control. Four Performance Editor sets are provided. For each set, any of the more than 200 program parameters can be assigned to a knob, meaning that up to 4 parameters can be assigned for control by one knob. Performance Editor settings are also stored independently for each program.

5 The powerful arpeggiator function automatically arpeggiates the notes in a chord you press. Five preset patterns and five user patterns are provided. User patterns allow you to create and store your own arpeggiation pattern of up to 24 steps. Preset patterns also allow you to modify and store the spacing between steps, and the velocity of each step, etc. When an optional SRC-512 RAM memory card is used, an additional 5 preset patterns and 5 user patterns will be available. Arpeggio playback can be synchronized to MIDI clock messages.

Thank you for purchasing the Korg *Prophecy Solo Synthesizer*.

In order to enjoy many years of trouble-free use, please read this manual carefully and use the unit correctly.

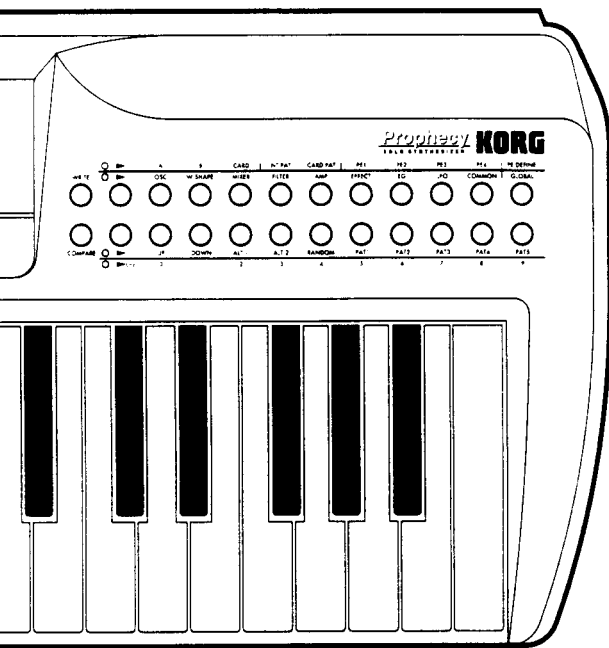

Multi Oscillator Synthesis System

6 Portamento and Octave Up/Down functions are provided, and can be switched on/off from the front panel or using an optional EC5 external controller. These controllers can also be used to switch effects or the arpeggiator on/off, allowing you to concentrate on your keyboard playing.

7 The Prophecy provides not only equal temperament, but also a variety of unconventional tunings such as Pythagorean and Werckmeister, and scales used in Arabian and Indonesian music. These can be specified for each program, allowing you to cover a wide range of musical genres. You are also free to create and use your own original scales.

8 In the **MOSS (Multi Oscillator Synthesis System)** tone generator of the Prophecy, the basic sound created by the two sets of oscillator, sub oscillator, and noise generator is passed through the Wave Shape, Mixer, Filter, Amp, and Effect blocks to shape the sound. In each of these blocks, general purposes EGs and LFOs can be used as modulation sources. While the Prophecy is a cutting-

edge digital synthesizer that uses the very latest in DSP technology, it also provides the possibilities for detailed manipulation that were characteristic of analog synthesizers, letting you turn your imagination into sound.

9 The Oscillator block provides seven types of oscillators, such as Analog, VPM, and Physical Modeling, and also contains a Sub Oscillator and Noise Generator. The Wave Shape block can be set to either Clip or Resonant wave shaping, and determines how the waveform is shaped and the balance at which it is mixed with the original waveform. The Mixer Block determines the levels at which the two systems of Oscillator, Sub Oscillator, Noise Generator, and Feedback are sent to the Filter block. The Filter block provides two multi-mode filters (switchable between LPF/HPF/BPF/BRF), and can be placed in either series or parallel to control the output. The Amp block lets you independently control the level of each output signal. The Effect block provides seven types of effect; Distortion, Wah, Chorus/Flanger+Delay, Reverb, and Dual Parametric EQ. (You may select either Chorus/Flanger+Delay or Reverb.)

Contents

Important Safety Instructions	
The Backup Battery	i
Memory Card RAM	i
Main features of the Prophecy	ii

1. Front and rear panel	2
1.1 Front panel	2
1.2 Rear panel	4
2. Basic operation	4
2.1 Setup	4
Basic connections	4
Connecting pedals, etc.	4
Connections with MIDI devices	5
2.2 Turning the power on/off	6
Turning on the power	6
Turning off the power	6
2.3 Adjusting the volume	6
2.4 Listening to the demo playback	7
2.5 Playing a program	8
About the Performance mode display	8
Selecting a program	8
Using the EC5 to select programs	10
Using MIDI to select programs	10
The PORTAMENTO effect	10
OCTAVE UP/DOWN	10
2.6 Performance editor(PE)	11
Selecting a performance editor	11
About the performance editor display	11
Saving a sound that was modified by the performance editor	11
2.7 Various playing techniques	12
Control from the keyboard	12
Control from WHEEL 1/2/3, the RIBBON controller, or the pedal volume	12
Control from a pedal switch or EC5	14
2.8 A Using the arpeggiator	15
Arpeggiator functions	15
Selecting the arpeggiation pattern	15
Basic arpeggiator operation	16
2.9 Other settings (Performance)	17
Specifying the order in which notes are sounded	17
Making the note sustain	17
Using key velocity to affect modulation	17
Using different scales	17
Tuning the Prophecy to other instruments	17
Transposing the pitch	17
Changing the velocity and aftertouch curves	17

This chapter explains the basic operation you need to know to use the Prophecy, such as selecting programs, using controllers, and using the arpeggiator. Settings which will affect the way in which the Prophecy is operated are marked by an asterisk "*". Before changing such settings, we recommend that you read this chapter and master the basics of operation.

3. How the Prophecy is organized	18
3.1 About modes	18
Performance mode	18
Edit mode	18
Pattern Define mode	18
3.2 Moving between modes	19
3.3 Moving through the sections of Edit mode	20
3.4 Moving between pages of Performance Editor Define, Pattern Define mode, and Edit mode	20
3.5 Moving the cursor in Performance Editor Define, Pattern Define mode, and Edit mode	21
3.6 Setting values in Performance Editor Define, Pattern Define mode, and Edit mode	21
3.7 About the screen display	21
Performance mode	21
Performance Editor Define, Pattern Define mode, Edit mode	22

This chapter explains concepts that you need to know to take full advantage of all the functions of the Prophecy; how it is organized into modes, how to move between modes, sections and pages, and how to set parameter values.

Refer to this chapter when making settings for the functions marked "*" in "2. Basic operation".

4. Edit	23
4.1 How a program is organized	23
OSC (Oscillator) section	23
Wave Shape section	23
Mixer section	24
Filter section	24
AMP (Amplifier) section	24
Effect section	24
EG section	24
LFO section	24
Common section	24
Global section	24
Oscillator types	25
Oscillator Sets	25
4.2 Editing a program	26
Initializing a program	26
Oscillator settings	26
Filter settings	27
Amp settings	28
Using effects	28
Setting and using controllers	29
4.3 Saving a program	30
Memory protect	30
Rename	30
Writing procedure	31
4.4 Compare	31
4.5 Performance Editor assignments (Performance Editor Define)	32
4.6 Arpeggio Pattern settings (Pattern Define)	33
4.7 Creating Pattern parameters (Pattern Define)	34

This chapter explains how each program of the Prophecy is organized, and uses examples to explain the process of editing a program, assigning performance edit parameters, and setting the arpeggiator pattern.

For a more detailed explanation of the parameters or the parameters not explained in this section, please refer to the separate "Parameter Guide".

4.8 Other settings (Edit)	35
Loading preset data	35
Saving data	35
Initializing, Copying, or Exchanging data within a section of the same program	35
Initializing	35
Adjusting the controllers	35

5. MIDI applications **36**

This section explains how to connect the Prophecy to external MIDI devices so that they can control each other.

5.1 MIDI channels	36
5.2 Note On/Off	36
5.3 Selecting programs	36
5.4 Bank Select	37
5.5 Applying aftertouch	37
5.6 Applying pitch bend	37
5.7 Damper (Hold) pedal	37
5.8 Adjusting the volume	37
5.9 Applying vibrato (pitch modulation)	38
5.10 Control the stereo location (pan)	38
5.11 If the sound does not stop	38
5.12 Stopping the sound from an external MIDI device	38
5.13 To reset all controllers on a given channel	38
5.14 About MIDI System Exclusive messages	39
5.15 Transmitting sound program data (Data Dump)	39
5.16 Editing sound programs, etc.	39
5.17 The Performance Editor	40
5.18 Synchronizing the arpeggiator	40
5.19 Arpeggiator velocity and gate	40

MIDI Implementation Chart **41**

Voice Name List..... **42**

Specifications **44**

Options **44**

1

Front and rear panel

1.1 Front panel

■PAGE LEFT key, PAGE RIGHT key

In Performance mode, these keys allow you to select programs by category. → p.9

These keys switch between the pages that appear in the display in Define and Edit modes. Press the PAGE RIGHT key to move to the page to the right. Press the PAGE LEFT key to move to the page to the left. → p.20

■CURSOR < key, CURSOR > key

In Performance mode, simultaneously pressing both of these keys will enter Demonstratin Playback mode. → p.7

These keys select from up to 5 parameters or menu items that appear in each page in Define and Edit modes. → p.21

ARPEGGIATOR

■ARPEGGIO ON/OFF key

■PATTERN DEFINE key

■OCTAVE key

■LATCH/KEY SYNC key

■SPEED

These are the controls for the arpeggiator; on/off, etc. → p.15

■VOLUME

This knob adjusts the overall volume of the Prophecy. This simultaneously adjusts the volume from the OUTPUT jacks (rear panel) and from the PHONES jack. → p.6

■WHEEL 3 HOLD key

Pressing this key while operating WHEEL 3 will hold the effect where it is at that moment. The effect will be held even if you return WHEEL 3 to its original position. An LED will light while the Hold function is on. Press the key again to turn it off. If Hold is on and you move WHEEL 3 through the location where the HOLD key was pressed, Hold will be defeated automatically. → p.13

■PORTAMENTO key

This key turns portamento on/off.

When Portamento is on, the switch LED will light. → p.10

■OCTAVE UP key

■OCTAVE DOWN key

These keys shift the range of the keyboard in 1-octave increments. → p.10

The operations and functions of the Prophecy such as selecting a Program or editing a Performance, Arpeggiator setting, or Edit Program are grouped broadly into modes; Performance mode, the Define modes (Performance Editor Define and Pattern Define), and Edit mode. For details refer to page 18.

■Display

In Performance mode, this 40 character x 2 line LCD display shows the name of the currently selected sound or performance editor settings. In Define and Edit modes it displays parameters. → p.8, 11, 21, 22

■Knobs 1 ~ 5

In Performance mode, these knobs adjust the value of the parameter assigned to each knob, allowing you to control the sound as you play. → p.11

In Define and Edit modes, these knobs move the cursor and modify parameter values. → p.21

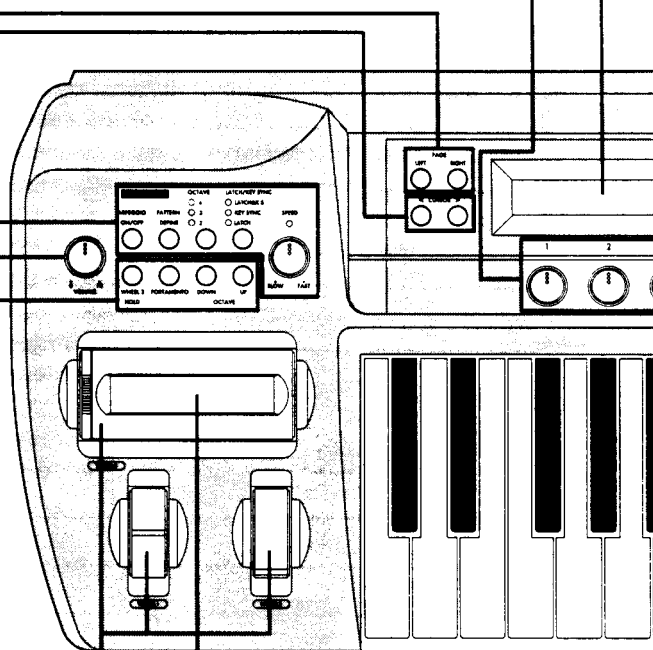

■RIBBON (ribbon controller)

This is a multi-assignable controller. By moving your finger on the controller to the left or right, or by pressing down, you can control assigned parameters such as pitch or modulation. → p.13

■PHONES jack

A set of headphones can be connected to this stereo mini-jack.

■WHEEL1, WHEEL2, WHEEL3 (control wheel 1,2,3)

These are assignable wheel controllers. By rotating the wheel you can control assigned parameters such as pitch or modulation. → p.12, 13

VALUE - key, VALUE + key

In Performance mode, these keys select the program to play. → p.9
 When writing a program, these keys select the writing destination program. → p.31
 In Define and Edit modes, these keys modify the value of the parameter where the cursor is located. → p.21

EXIT key

This key is used to exit the current mode or function; such as moving from Performance Editor Define or Pattern Define modes back to the previous mode, moving in Edit mode to an upper level, or canceling an operation or setting that you are being asked to confirm.

PERFORMANCE/EDIT Select key

This key switches the function of the keys located to its right, alternating between the Performance mode functions (the upper LED will light) and the Edit mode functions (the lower LED will blink).

- | | |
|---|---|
| <ul style="list-style-type: none"> ■ A/OSC key ■ CARD/MIXER key ■ CARD PAT/AMP key ■ PE2/EG key ■ PE4/COMMON key | <ul style="list-style-type: none"> ■ B/W.SHAPE key ■ IN PAT/FILTER key ■ PE1/EFFECT key ■ PE3/LFO key ■ PE DEFINE/GLOBAL key |
|---|---|

These keys access the function selected by the PERFORMANCE/EDIT Select key.

When the LED above the PERFORMANCE/EDIT Select key is lit (Performance mode),

- —> these keys select the Program Bank (A,B,Card), the Arpeggiator Pattern Bank (IN PAT, CARD PAT), turn on/off the Performance Editor (PE1, PE2, PE3, PE4), and enter Performance Edit mode.

When the LED below the PERFORMANCE/EDIT Select key is blinking (Edit mode),

- —> these keys access the various section of Edit mode (OSC, W.SHAPE, MIXER, FILTER, AMP, EFFECT, EG, LFO, COMMON, GLOBAL).

PATTERN/PROGRAM Select key

This key switches the function of the keys located to its right; they will either select performance mode arpeggio patterns (the upper LED will blink) or act as numeric keys to select programs (when the lower LED is lit).

When Performance Editor Define, Pattern Define mode, or Edit mode are selected, both LEDs will go off. In this case, the keys act as +/- input keys for the parameter value.

Both LEDs will also be off when waiting for a Program Write operation to be executed. (In this case the keys located to the right will not function at all.)

- | | |
|---|---|
| <ul style="list-style-type: none"> ■ UP/0 key ■ ALT 1/2 key ■ RANDOM/4 key ■ PAT2/6 key ■ PAT4/8 key | <ul style="list-style-type: none"> ■ DOWN/1 key ■ ALT 2/3 key ■ PAT1/5 key ■ PAT3/7 key ■ PAT5/9 key |
|---|---|

These keys access the function selected by the PATTERN/PROGRAM Select key.

When the LED above the PATTERN/PROGRAM Select key is blinking,

- —> These keys select arpeggiator patterns (UP, DOWN, ALT 1, ALT 2, RANDOM, PAT 1, PAT 2, PAT 3, PAT 4, PAT 5).

When the LED below the PATTERN/PROGRAM Select key is lit,

- —> The keys will act as numeric keys to select programs (0, 1, 2, 3, 4, 5, 6, 7, 8, 9).

When both of the PATTERN/PROGRAM Select LEDs are off,

- —> These keys will act as numeric keys for entering parameter values in Define and Edit modes.

WRITE key

This key writes the settings of the currently selected program. → p.31
 If the program is protected, a message will appear and the operation will be canceled.

COMPARE key

When editing program parameters, this key allows you to call up the original values of the program. Alternatively, if you have not yet written your edits, this key allows you to audition other programs without losing your edits (For example, to find an alternate writing destination). → p.31

ENTER key

This key is used to finalize the input from the numeric keys, to confirm when writing a program or executing a utility function. When you have made a change that requires confirmation or execution, the LED will blink. → p.21
 This key is also used to finalize a selection in a menu page. (In this case the LED will not blink.)
 → p.20

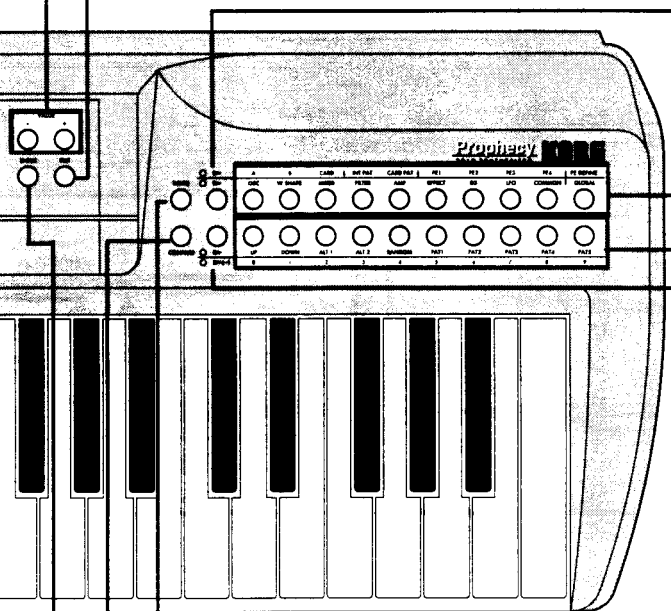

2

Basic operation

■MEMORY CARD

An optional card containing (or for storing) programs and arpeggiator patterns can be inserted here.

■POWER(power switch)

This switch turns the power on/off. → p.6

■AC power inlet

Connect the included AC cable to this inlet. After connecting the AC cable here, connect the other end to an AC outlet.

1.2 Rear panel

■EC5 jack

Connect an EC5 External Controller (sold separately) to this jack. By pressing the switch, you can turn on/off the assigned function. → p.14

■MIDI connectors (IN, OUT, THRU)

External MIDI devices can be connected to these connectors. MIDI IN receives messages from an external MIDI device. MIDI OUT transmits messages from the Prophecy to external MIDI devices. MIDI THRU re-transmits messages that were received at MIDI IN. → p.36

2.1 Setup

⚠ Be sure that the power is turned OFF when making any connections.

Basic connections

1 Connect the power cable.

2 Connect the audio cables.

In order to take full advantage of the high quality sound of the Prophecy, we recommend that you use a stereo system if possible. If you are connecting it in mono, use the L/MONO jack.

In order to faithfully reproduce the sound of the Prophecy, we recommend that you use a powered monitor (a powered speaker such as the PM-15 [sold separately]). If you use the amp of your stereo audio system or a portable cassette-radio with an external input, connect the audio cable from the Prophecy to the jack marked LINE IN, AUX IN, or External Input, etc. Please be aware that if you play the Prophecy through your stereo system or a cassette-radio, you should keep the volume down, since excessive volume can damage your speakers.

If you are using headphones, connect them to the PHONES jack located at the left front of the Prophecy.

Connecting pedals, etc.

By connecting a pedal volume, pedal switch, and an EC5 external controller, you can enjoy an even wider range of performance possibilities. Connect these devices as desired.

3 Connect the pedal volume (EXP-2, XVP-10 etc. [sold separately]) to the rear panel FOOT PEDAL connector. The polarity of the pedal volume (the Max./Min status) is determined by the Global section page GLB-4 [Sens & Polar] Foot Pedal Polarity setting.

4 Connect the pedal switch (PS-1/2, DS-1/2 etc. [sold separately]) to the rear panel FOOT SWITCH connector. The polarity of the pedal switch (the ON/OFF status) is set by the Global section page GLB-4 [Sens & Polar] Foot SW Polarity setting.

5 Connect the EC5 external controller [sold separately] to the rear panel EC5 connector.

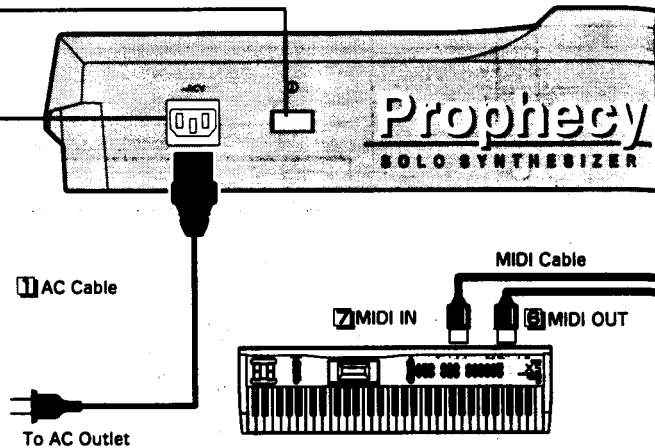

■FOOT PEDAL jack

A pedal volume such as the EXP-2 or XVP-10 (sold separately) can be connected to this jack. By pressing (or releasing) the pedal you can modify the value of the assigned parameter. → p.13

■RIBBON SENSE (ribbon controller sensitivity)

This allows fine adjustment of the ribbon controller sensitivity.

☉ will lower the sensitivity, and ☺ will increase the sensitivity.

■FOOT SW jack

A pedal switch such as the FS-1 or 2 (sold separately) can be connected to this jack. This allows you to turn on/off the assigned function. → p.14

■OUTPUT jacks (L/MONO, R)

These are the output jacks. Your power amp, stereo amp, mixer, or multi-track recorder etc. can be connected here. If you are listening in mono, use the L/MONO jack.

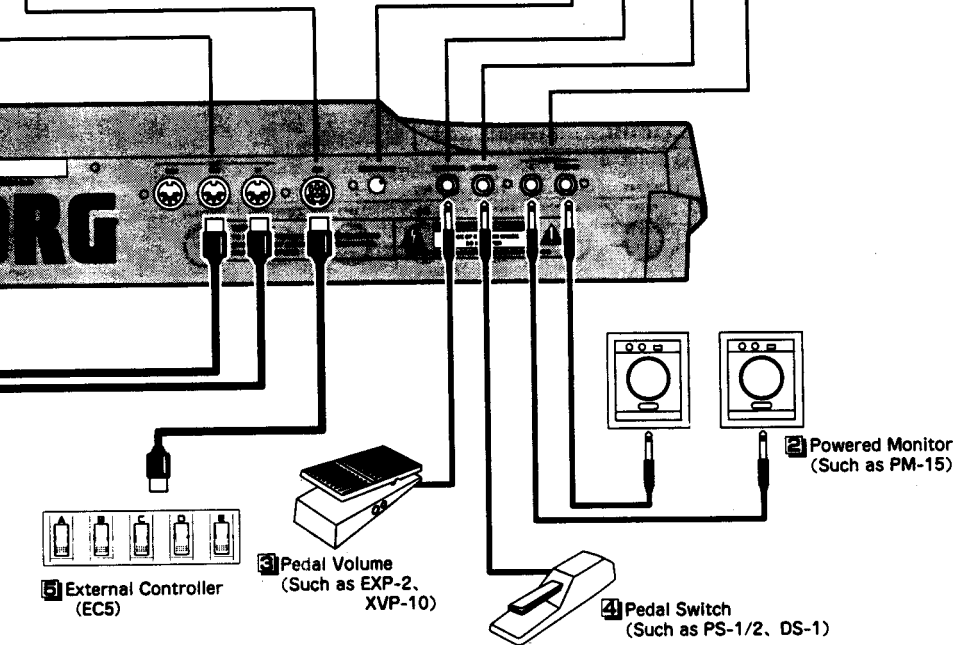
**Connections with MIDI devices**

By connecting MIDI cables to the MIDI connectors of the Prophecy, you can use external MIDI devices to play the Prophecy, or use the keyboard of the Prophecy to play external MIDI devices.

- ※ If you are using the Prophecy by itself, there is no need to make the following connections.
- 6** If you wish to use another MIDI keyboard or a computer or sequencer to control the Prophecy, use a MIDI cable to connect the MIDI OUT connector of the other MIDI device to the MIDI IN connector of the Prophecy.
- 7** If you wish to use the keyboard and controllers of the Prophecy to play another MIDI tone generator or to record into a computer or sequencer, use a MIDI cable to connect the MIDI OUT connector of the Prophecy to the MIDI IN connector of the other MIDI device.
- ※ By using MIDI THRU connectors, you can connect two or more MIDI devices, but to prevent problems, we recommend that you connect no more than 2 or 3 devices using MIDI THRU. If you wish to connect more MIDI devices than this, use a MIDI patch bay.

«When connecting a computer/sequencer»

If you will be using the keyboard of the Prophecy to record into the computer or sequencer, and also using the Prophecy as a tone generator (i.e., when the Prophecy is used both as the MIDI keyboard for input and also as a MIDI tone generator), connect the Prophecy and the computer/sequencer to their respective MIDI OUT and MIDI IN connectors. In this setup, if the computer/sequencer's Echo Back setting is turned ON (so that messages received at its MIDI IN will be re-transmitted from MIDI OUT), notes played on the Prophecy's keyboard will be played (echoed) once again by the message being re-transmitted from the computer/sequencer. To prevent this from happening in such cases, set the Prophecy to Local OFF (to break the internal connection between the keyboard section and the tone generator section). The Local OFF setting is made in the Global section page GLB-8 [MIDI] Local.

- ※ If Local is OFF, the Prophecy will not produce sound by itself; i.e., playing the keyboard will not produce sound. If you are using the Prophecy by itself, turn Local ON.
- ※ To connect the Prophecy to a computer, you will need a MIDI interface.

2.2 Turning the power on/off

Turning on the power

- 1 When all necessary connections are complete, press the POWER switch to turn on the power of the Prophecy.
- 2 Turn on the power for your powered speakers or stereo amp.

When the Prophecy's power is turned on, the opening screen will be displayed for several seconds, and then the Performance mode page will appear.

Immediately after power-on, you will always be in this mode. Program A00 (*1) will be selected, and the arpeggio pattern that was last selected when the power was turned off will be selected.

*1. If the Global section page GLB-21 Page Memory setting is turned ON, the program that was selected when the power was turned off will be selected.

Example of the Performance mode display

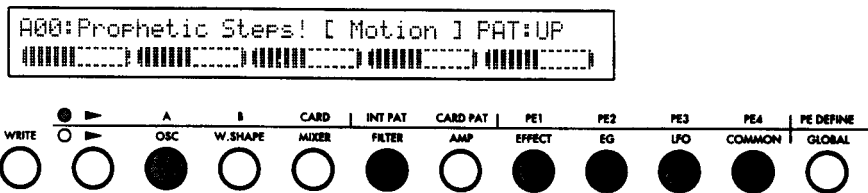

Turning off the power

Press the POWER switch once again, and the Prophecy's power will go off. Turn off the power to your powered speakers or stereo amp before turning off the Prophecy.

2.3 Adjusting the volume

Rotate the VOLUME knob to set an appropriate volume. This knob also sets the headphone volume.



«Getting back into Performance mode»

The Prophecy allows you to move easily between the various modes and operations such as Program Write or Demo Playback. This means that until you become accustomed to operating the Prophecy, you may inadvertently move to some other mode or to an unfamiliar display. If you ever need to get back to Performance mode, use the following procedure.

If the Performance mode display shown above does not appear in the LCD, check the following points.

1. Turn on the Performance (upper) LED for the PERFORMANCE/EDIT select key. If the Edit (lower) LED is blinking, press the PERFORMANCE/EDIT Select key to make the upper LED light.

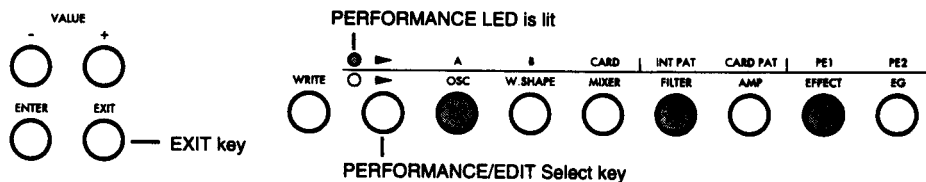

If pressing the PERFORMANCE/EDIT Select key does not switch the LED, you have entered Pattern Define mode or Program Write from Edit mode. Repeatedly press the EXIT key until the screen display no longer changes. Then press the PERFORMANCE/EDIT Select key to make the upper LED light.

2. If the upper LED of the PERFORMANCE/EDIT Select key is lit and the display is different than that shown above, press the EXIT key until the display no longer changes.

2.4 Listening to the demo playback

The Prophecy contains 16 demo songs that demonstrate its capabilities.

- 1** Make sure that you are in Performance mode.
For details refer to page 6.
- 2** Simultaneously press the CURSOR < and CURSOR > keys to enter Demonstration mode.
(The ENTER key LED will blink.)

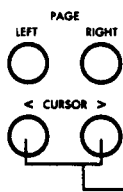

Example of screen display in Demonstration mode

```
**** KORG Prophecy DEMONSTRATION ****
#01"A06:The Big One"    <Press ENTER >
```

- 3** Either rotate KNOB 1 or use the value +/- keys to select the demo song.
The name of used program is indicated.

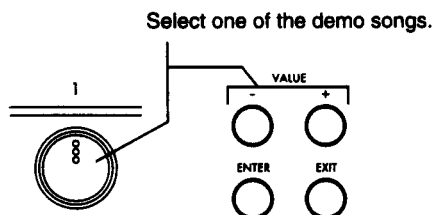

- 4** To begin playback, press the ENTER key.
The demo songs are refrained from the selected song.

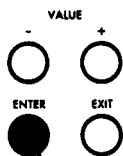

Example of screen display during demo playback

```
**** KORG Prophecy DEMONSTRATION ****
#01"A06:The Big One"    <Now Playing >
```

- 5** If you wish to stop playback, press the EXIT key. (The ENTER key LED will blink.)
If you wish to listen to the playback again after stopping repeat step **3**.

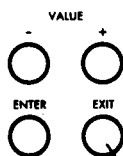

- 6** To exit Demonstration mode, press the EXIT key while playback is stopped.

2.5 Playing a program

There are 128 programs in internal memory (00~63 in bank A, and 00~63 in bank B). If an optional card is inserted, you can select from an additional 64 programs (00~63 in the Card bank).

■ About the Performance mode display

In Performance mode, the display will be as shown below. The selected bank key and Performance Editor (PE) key LEDs will light.

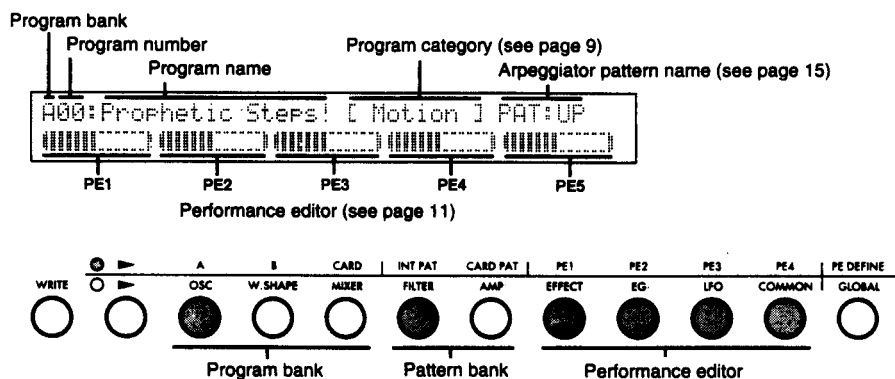

■ Selecting a program

Press the PERFORMANCE/EDIT Select key to enter Performance mode (see page 6). Programs are selected in Performance mode.

Selecting the program bank

You can select from bank A, bank B, and (if a card is inserted) the Card bank. Use the following procedure to select the bank.

- 1 Press the desired bank key (the A key for bank A, the B key for bank B, or the CARD key for the Card bank (*1)) to reserve the bank. The LED of the bank key that you pressed and the ENTER key LED will begin blinking. At this point the bank has not yet been changed. The LED of the currently selected bank key is lit.



*1 If a card is not inserted, pressing the CARD key will produce an error message, and the bank will not change. Inserting or removing a card should be done while the power is turned off.

- 2 Use one of the following methods to finalize the bank you reserved in step 1.
 - Once again press the bank key you pressed in step 1, or press the ENTER key. The program number will remain the same, and only the bank will change.
 - Use the numeric keys (and the ENTER key) to select a program number (refer to the following explanation of "Selecting a program number", "Numeric key input".) The bank and program number will change.
- Use one of the following methods to cancel the reservation you made in step 1.
 - Press the EXIT key or the currently selected (lit) bank key. The blinking will stop, and you will return to the condition before step 1.
 - Press a bank key which is not lit or blinking. That bank key will begin blinking and enter the (reserved) status of step 1.
 - Press the VALUE key. You will return to the currently selected bank, and the program number will change.

Selecting the program number

Each bank contains 64 programs (00~63). You can use one of the following five ways to select a program.

➤ **1** Using the VALUE+ and VALUE- keys

Pressing the VALUE+ key will select the next higher program number, and pressing the VALUE- key will select the next lower program number.

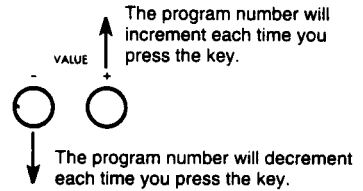

If you press the VALUE+ key when program A63 is selected, program B00 will be selected. If you press the VALUE+ key when program B63 is selected, program C00 will be selected if the Card bank is available (i.e., if a card is inserted). If not, program A00 will be selected. If program C63 is selected, pressing the VALUE+ key will select program A00. The VALUE- key will have the opposite effect.

➤ Using the numeric keys

Press the PATTERN/PROGRAM Select key to make the LED light as shown below. Each time you press the key, the upper and lower LEDs will alternate.

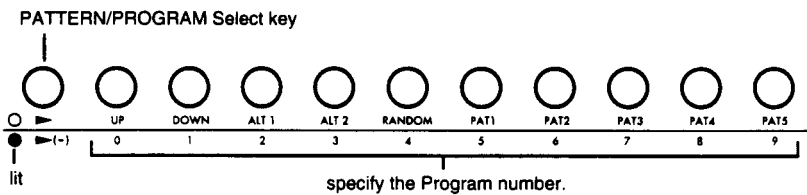

➤ **2** Two-digit entry using the numeric keys

Use the numeric keys to specify a two-digit number. To select a program 0~9, press 0 first, and then press the desired number. If you enter a number above 63, program 63 will be selected.

➤ **3** Numeric keys + ENTER key (10's Hold: OFF)

The 10's place will be fixed at 0, and the numeric keys will enter the value of the 1's place.

➤ **4** Numeric keys + ENTER key (10's Hold: ON)

The 10's place will be fixed at its current value, and the numeric keys will enter the value of the 1's place.

*Methods **3** and **4** are selected by the setting in Edit mode Global section page GLB-21 [Page Memory & 10's Hold]. With the factory settings, this is OFF.

Example: If program 58 is selected, the following operations will select ...

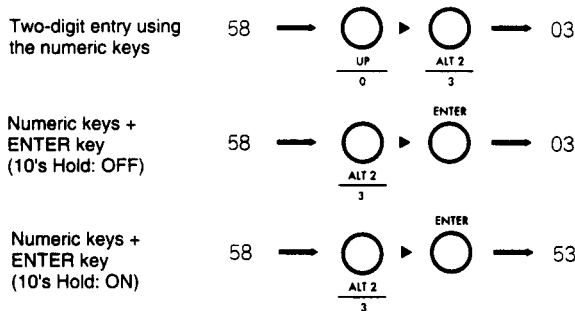

➤ **5** Selecting programs by Program Category

You can search for and select programs that have the same category as the currently selected program.

Press the PAGE RIGHT key to select higher-numbered programs, and press the PAGE LEFT key to select lower-numbered programs.

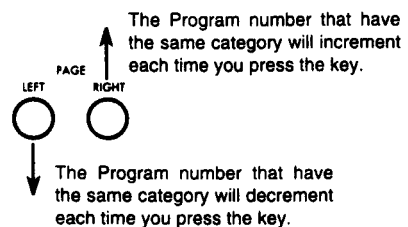

■ Using the EC5 to select programs

If an external controller (EC5 [sold separately]) is connected to the EC5 jack, you can select programs from the EC5. The Prophecy allows you to assign various control functions to the EC5.

* These settings are made in Edit mode Global section, page GLB-7 [EC5 Function].

■ Using MIDI to select programs

You can select programs by transmitting a Program Change message from an external MIDI device to the Prophecy (see page 36).

■ The PORTAMENTO effect

Portamento is an effect that produces a smooth change in pitch between two notes that you play. This effect will be active when the PORTAMENTO key has been pressed to turn portamento ON (the LED is lit). Pressing the key will alternately switch the effect on/off.

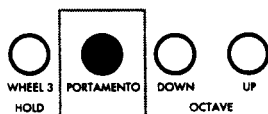

The Portamento ON/OFF setting can be stored for each program. For the writing procedure, refer to page 31.

* If the Edit mode page OSC-cmn6 [Portamento] Portamento Time parameter is set to 0, switching the PORTAMENTO key ON will produce no effect.

* The Edit mode OSC section page OSC-cmn6 [Portamento] Fingered Mode parameter allows you to select one of the following two types of portamento.

NORMAL

Portamento will always apply, regardless of how you play.

FINGERED

Portamento will be applied only when you play the next note before releasing the previous note.

■ OCTAVE UP/DOWN

These buttons shift the pitch of the keyboard in 1-octave steps. Press the OCTAVE UP or OCTAVE DOWN key to turn on the effect (LED lit or blinking). When the LED is unlit, the keyboard is in its normal pitch range.



* The Edit mode Global section page GLB-4 [Sens & Polar] Octave SW Mode parameter allows you to select one of the following settings.

LAT (latched) (factory setting)

When you press the UP key or the DOWN key, the LED will light and the keyboard pitch will be shifted 1 octave. When the UP key LED is lit, pressing the UP key once again will make the UP key LED begin blinking, and the pitch will rise to 2 octaves above the initial pitch range.

Conversely, when the UP key LED is lit or blinking, pressing the UP key will alternate between 2 octaves up and 1 octave up. When the UP key LED is lit, pressing the DOWN key will return the keyboard to the initial pitch range. When the UP key LED is blinking, pressing the DOWN key will return the keyboard to 1 octave above its normal range. The same applies in the downward direction.

ULAT (unlatched)

The keyboard will be shifted 1 octave up or down only while the OCTAVE UP key or OCTAVE DOWN key is being pressed.

2.6 Performance Editor (PE)

Modifications to the sound of a program are done in Edit mode. However in Performance mode, you can also assign any desired parameter (* 1) to knobs 1~5, allowing you to adjust volume or brightness of the sound, envelope speed (the time over which the sound rises or decays), or effect settings. This capability is referred to as the Performance Editor (PE) function. Each program has four PE sets. If two or more PE sets are turned on, one knob can modify up to 4 different parameters at once.

*1 Parameters are assigned to the Performance Editor in Performance Editor Define (see page 32).

■ Selecting a Performance Editor

When one of the PE1~4 keys are pressed to make the LED light, that Performance Editor is turned on. The previously selected PE will be turned off. Pressing the key of a currently-on PE will also turn it off. If you wish to turn on two or more Performance Editors, press the desired PE keys simultaneously. PE keys that were not pressed will be turned off. To turn off PE keys that are on, individually press the PE keys that are on.

With a PE turned on, rotate knob 1~5 to modify the value of the parameters assigned to them, and listen to the tone change.

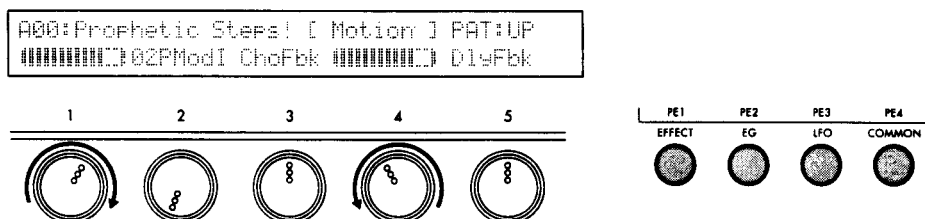

■ About the Performance Editor display

Rotate a knob, and the value will change.

If after rotating a knob you then select another program (or if you enter Define or Edit mode, rotate a knob, and then return to Performance mode), an arrow will appear in the display as shown below. This indicates that the physical position of the knob differs from the value memorized in the program. Rotate the knob in the direction of the arrow until it reaches the location of the program setting, and from that point the knob will once again control its assigned parameter(s).

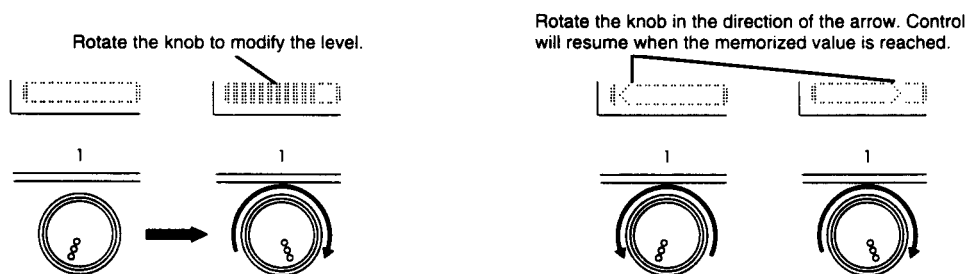

When PE1~4 are turned on, the display will show an abbreviated name for the parameters assigned to each knob.

■ Saving a sound that was modified by the Performance Editor

Changes you make to a sound in Performance mode by operating the Performance Editor can be saved. For the Write procedure, refer to "4.3 Saving a program" (page 30).

2.7 Various playing techniques

By operating the Performance Editor and controllers (WHEEL 1-3, the ribbon controller, a connected foot switch etc.), and by varying the way that you play the keyboard, you can modify the volume, brightness, envelope speed (the length of the attack or decay), and effect settings, and in this way add expressiveness to your playing.

■ Control from the keyboard

Various control functions (*1) can be assigned within each program, allowing your playing to be more expressive.

*1 In Edit mode, you can independently specify the amount of control for the oscillator, filter, and effect parameters, and use one of the following control functions as a modulation source.

Velocity

This provides control based on the force with which you play a note.

After Touch

This provides control based on pressure applied to the keyboard after playing a note.

PORTAMENTO

This button controls the Portamento effect to create smooth pitch change between two notes.

Note Number

The note number of the key you press can affect a parameter in the way that you specify, for example by increasing the effect as you play higher on the keyboard.

■ Control from WHEEL 1/2/3, the RIBBON controller, or the pedal volume

Various control functions (*2) can be assigned within each program, allowing your playing to be more expressive.

*2 To assign a controller to a parameter, make settings in Edit mode Common section pages CMN-5-9. The depth of the change can be set for the modulation source for each parameter. For details on these settings, refer to "Setting and using controllers" (page 29).

WHEEL 1

Rotating the wheel away from or toward yourself will apply the effect. This controller is normally used for Pitch Bending. For programs whose OSC type is Brass (Reed), the pitch bender will produce a Mode Jump effect characteristic of brass (reed) instruments.

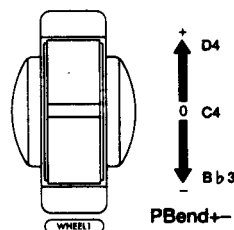

Here's what happens when Edit mode Common section page CMN-5 Control Wheel 1 is set to PBend+-.
The example is for when the C4 key is played and OSC section page OSC-cmn5 PB Intensity (+X) is set to +02 and PB Intensity (-X) is set to -02.

*3 Setting the Edit mode Common section page CMN-5 Control Wheel 1 controller function to PBend+- will result in a pitch bend of 0 when WHEEL 1 is in the center position, and +/- pitch bend when the wheel is moved away from or toward yourself. With settings such as PBend+, Atouch, or CChg #00-95, the center position of the wheel will produce 0 and moving the wheel away from yourself / toward yourself will produce a +/- effect. A setting of PBend- will produce a -/- effect.

The +/- polarity of the resulting effect will depend on the parameter setting.

WHEEL 2

The effect will increase as the wheel is moved from the lowest position away from yourself. Normally this wheel is used to adjust the depth of vibrato.

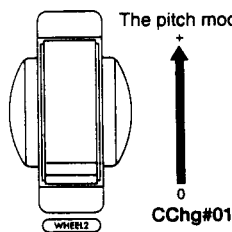

Here's how WHEEL 2 functions when the Edit mode Common section page CMN-5 Control Wheel 2 parameter is set to CChg#01. The example is for when the Edit mode OSC section page OSC1-4 Int.CC#1 Ctr1 parameter is set to +.

WHEEL 3 +direction

WHEEL 3 -direction

The effects will be applied as you move the wheel away from or toward yourself, relative to the center 0 position.

If separate functions are assigned to WHEEL 3+ and WHEEL 3-, different effects can be applied by moving the wheel in the + or - direction.

WHEEL 3 HOLD key

If this key is pressed while WHEEL 3 is being operated, the effect at that moment will be held, and will continue even after WHEEL 3 returns to its original position. While Hold is on, the LED will light. Press the key once again to defeat the hold function. When WHEEL 3 is at the 0 position, press the key once again to re-apply the effect that was previously held. Also, if WHEEL 3 returns to the held location while hold is still on, hold will automatically be canceled.

While Hold is on, you can move the wheel in the other direction to apply both effects simultaneously.

RIBBON (X)

The effect will be applied when you move your finger to left or right on the ribbon.

* Depending on the setting of Edit mode Common section page CMN-7 X Variable Center, this can be used in two ways.

OFF:

The left edge of the ribbon controller will be 0. If PBend+- is selected, the center will be 0.

ON:

The location where you first touch the ribbon controller will be 0.

RIBBON (Z)

The effect will be applied when you press down on the ribbon controller.

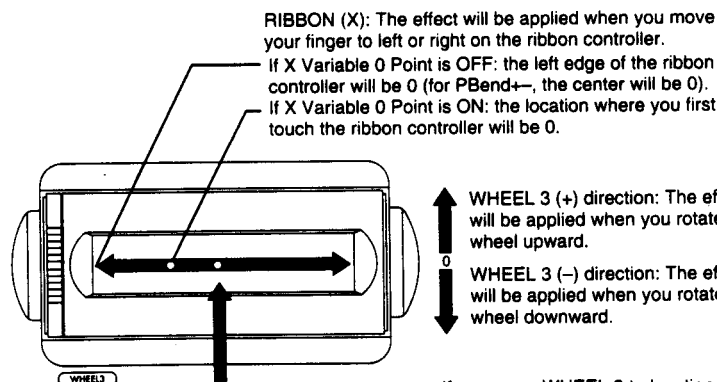

RIBBON (X): The effect will be applied when you move your finger to left or right on the ribbon controller.
 If X Variable 0 Point is OFF: the left edge of the ribbon controller will be 0 (for PBend+-, the center will be 0).
 If X Variable 0 Point is ON: the location where you first touch the ribbon controller will be 0.

RIBBON (Z): The effect will be applied when you apply pressure.

WHEEL 3 (+) direction: The effect will be applied when you rotate the wheel upward.
 WHEEL 3 (-) direction: The effect will be applied when you rotate the wheel downward.

If you move WHEEL 3 to location 'a' and press the WHEEL 3 HOLD key, the effect at 'a' will be maintained even if you return the wheel to the center. In this condition if you move the wheel to 'b', the effect specified for WHEEL 3- will be applied as well.

Pedal volume (optional)

Pressing a pedal volume (EXP-2, XVP-10, etc.) connected to the FOOT PEDAL jack will apply the specified effect.

* The polarity of the pedal volume can be switched in Edit mode Global section, page GLB-4 Foot Pedal Polarity.

■ Control from a pedal switch or EC5

Functions such as sustain pedal, program number up/down, octave up/down, portamento, effect, and arpeggiator on/off can be assigned for control from a pedal switch or EC5.

Pedal switch (optional)

A pedal switch (PS-1, PS-2, etc.) connected to the FOOT SW jack can turn an assigned function on/off.

* *Pedal switch function assignments are made in Edit mode Common section, page CMN-8 Foot SW. The polarity of the foot switch can be set in Edit mode Global section, page GLB-4 Foot SW Polarity.*

EC5 External Controller (optional)

By operating an EC5 External Controller connected to the EC5 jack, functions assigned to each of the five switches can be turned on/off.

* *Function assignments for the EC5 External Controller are made in Edit mode Global section, page GLB-7 [EC5 Function].*

2.8 Using the arpeggiator

The arpeggiator in the Prophecy contains 5 preset patterns (UP, DOWN, ALT1, ALT2, RANDOM) and 5 user patterns (PAT 1~5). For each user pattern you can create your own arpeggio pattern of up to 24 steps (see page 34). You can also make various settings to customize the preset patterns as well, such as modifying the step interval and the velocity and length of the arpeggio notes, giving you a wide variety of possibilities (see page 33).

■ Arpeggiator functions

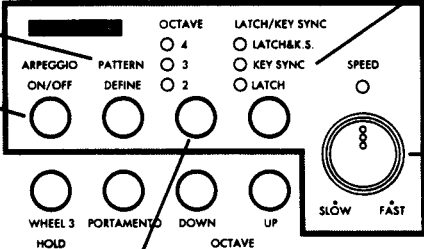

ARPEGGIO ON/OFF key
This key switches the arpeggiator on/off. When on, the LED is lit.

PATTERN DEFINE key
This key enters Pattern Define mode. In this mode you can make pattern settings. The LED will light while you are in Pattern Define mode. Press it again or press the EXIT button to return to the previous mode. For details on Pattern Define mode, see pages 33 and 34.

OCTAVE key
This specifies how the number of octaves over which the arpeggio pattern will be played. The setting will change each time the key is pressed.

1. (LED unlit): 1 octave
2. 2 (lit): 2 octaves
3. 3 (lit): 3 octaves
4. 4 (lit): 4 octaves

LATCH/KEY SYNC key
This selects how the keyboard will control arpeggiation. The setting will change each time the button is pressed.

1. (LED unlit): Arpeggiation will begin in synchronization with the specified speed, regardless of the timing at which you pressed the notes.
2. LATCH (lit): Arpeggiation will continue even after the notes are released.
3. KEY SYNC (lit): While with a selection of "1" (see above), the timing of the specified arpeggio speed (as indicated by the SPEED LED) will be maintained even if you take your hand off the keyboard and play the chord again. However if Key Sync is selected, arpeggiation will start at the moment that you play the notes.
4. LATCH & K.S. (lit): This combines the operation of 2 and 3.

SPEED (arpeggio speed)
This adjusts the tempo of arpeggiation. The LED located above the knob will blink at quarter note timing. If MIDI Clock messages from an external device are controlling the arpeggiator, the setting of this knob will be ignored (see page 40).

■ Selecting the arpeggiation pattern

Press the PERFORMANCE/EDIT Select key to enter Performance mode (see page 6).
Arpeggio patterns are selected in Performance mode

** It is not possible to do this while you are in the middle of selecting a program (i.e., when just one numeric key has been pressed).*

Selecting the Pattern Bank

Select either INT PAT or (when a card is inserted) CARD PAT.

- 1 Press the desired pattern bank key (INT PAT or CARD PAT*1) to make the LED blink. The ENTER key LED will also begin blinking. At this point the pattern bank has not yet changed.

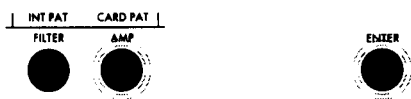

**1 If you press the CARD PAT key when no card is inserted, an error message will be displayed, and the bank will not change. Cards should be inserted or removed with the power turned off.*

2 Use one of the following operations to finalize the selection made in **1**.

- Either press the pattern bank key selected in **1** once again, or press the ENTER key. The pattern will remain the same, and only the pattern bank will change.
- Press one of the UP ~ PAT5 keys to select a pattern (refer to "Selecting the arpeggio pattern," below). The bank and arpeggio pattern will change.

If you wish to cancel the selection made in **1**, press the EXIT key or the currently selected (lit) pattern bank key.

Selecting the arpeggio pattern

- 1** Press the PATTERN/PROGRAM Select key to make the upper PATTERN LED blink. When this is done, the UP/0 ~ PAT5/9 keys will act to select patterns. Each time you press the PATTERN/PROGRAM Select key, the upper/lower LEDs will alternate between blinking/lit.

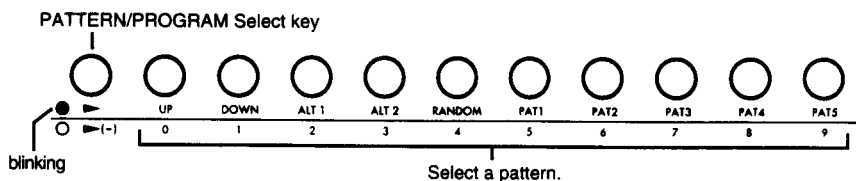

- 2** Press one of the UP ~ PAT5 keys to select the arpeggio pattern. When the pattern is selected, the upper right of the LCD will indicate the selected pattern as "PAT:UP", "PAT:DOWN" ... "PAT:PAT5".

Basic arpeggiator operation

- 1** Press the ARPEGGIO ON/OFF key to make the LED light. The arpeggiator function will be turned on. If you now press notes on the keyboard, an arpeggio will be played.
- 2** Rotate the SPEED knob to set the desired tempo.
- 3** Press the LATCH/KEY SYNC key to make LATCH light. When the LATCH function is on, the arpeggio will continue playing even after you take your hands off the keyboard. The LATCH/KEY SYNC key allows you to select one of four methods of operation (see "Arpeggiator functions" page 15).
- 4** Press the OCTAVE key to switch the range of the arpeggiation in 1-octave increments. As the LED is switched 2→3→4, the range of arpeggiation will change.

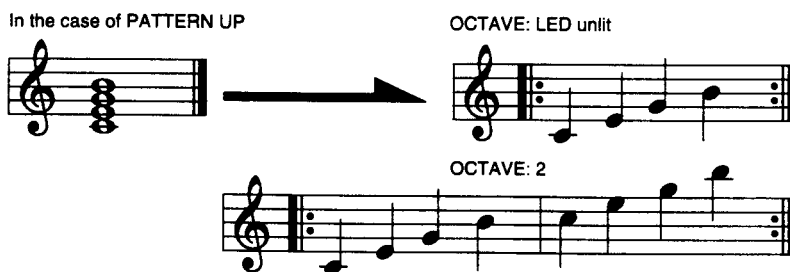

- 5** To stop arpeggiation, press the ARPEGGIO ON/OFF key to turn off the LED.

Try playing various chords, and use the UP ~ PAT5 keys to select different arpeggio patterns and hear the results.

* With the above procedure, notes will be sounded in the order of their pitch, regardless of the order in which they were pressed. You can also make Pattern Define settings so that notes will be sounded in the order that they were pressed. In addition, you can adjust the step interval and the velocity and length of the arpeggio notes, and create your own arpeggio pattern.

2.9 Other settings (Performance)

■ Specifying the order in which notes are sounded

You can specify whether the lowest/highest/last note will be sounded when two or more notes are pressed simultaneously. This can be set for each program.

* This is set by the *Edit mode Common* section, page CMN-3 [Voice Control] *Key Priority* setting (Parameter Guide, page 127).

■ Making the note sustain

A note can be made to continue sounding even after the keyboard is released. This can be set for each program.

* This is set by the *Edit mode Common* section, page CMN-3 [Voice Control] *Hold* setting (Parameter Guide, page 127).

■ Using key velocity to affect modulation

The force with which you play a new note while the previous note is still held can be used to specify whether the EG and LFO will continue their cycle, or will be re-started. This setting allows you to articulate slurs, etc. This can be set for each program.

* This is set by the *Edit mode Common* section, page CMN-3 [Voice Control] *Trigger Mode* setting (Parameter Guide, page 127).

■ Using different scales

In addition to the conventional equal tempered scale, the Prophecy provides other scale types such as Pythagorean, Werckmeister, Arabian, Indonesian, and also user scales. These can be selected for each program.

* This is set by the *Edit mode Common* section, page CMN-4 [Scale] setting (Parameter Guide, page 128).
User Scales allow you to create your own scale.

* This is done in *Edit mode Global* section, page GLB-3 [User Scale] (Parameter Guide, page 135).

■ Tuning the Prophecy to other instruments

When playing the Prophecy together with other instruments or when playing along with a CD or tape, you can adjust Master Tune in the range of 430 Hz ~ 450 Hz.

* Tuning is adjusted by the *Edit mode Global* section, page GLB-1 [Tune & Transpose] *Master Tune* setting (Parameter Guide, page 133).

■ Transposing the pitch

To shift the pitch in chromatic steps, you can adjust the Transpose setting over a range of -12 (one octave down) to +12 (one octave up).

* This is set by the *Edit mode Global* section, page GLB-1 [Tune & Transpose] *Transpose* setting (Parameter Guide, page 133).

■ Changing the velocity and aftertouch curves

The way in which velocity and aftertouch take effect can be changed by selecting from 8 types of curve.

* The *velocity curve* is determined by the *Edit mode Global* section, page GLB-2 [Curve & Effects] *Velocity Curve* parameter. The *aftertouch curve* is determined by the *After Touch Curve* located in the same page (Parameter Guide, page 134).

3

How the Prophecy is organized

3.1 About modes

The Prophecy has three modes.

■ Performance mode

```
A00:Prophetic Steps! [ Motion ] PAT:UP  
|||||) |||||) |||||) |||||) |||||)
```

In this mode you can play the Prophecy, and select program numbers, arpeggio patterns, and performance editor settings.

Programs: You can select from 128 programs (A00~64, B00~64) and an additional 64 programs (CARD 00~64) if a card is inserted.

Arpeggio patterns: You can select from 10 types (UP, DOWN, ALT1, ALT2, RANDOM, PAT1~5), and an additional 10 types (UP, DOWN, ALT1, ALT2, RANDOM, PAT 1~5).

Performance Editor: 4 sets (PE1~PE4)

Performance Editor Define

```
#PED-1[PE1 Definition]>Knob No.  
#1 012:OSC1 Octave 000% 100% LINEAR
```

This is where you make settings for the Performance Editor. There are six pages; PED-1 ~ PED-6 (one for each PE set).

From Performance mode, press the PE DEFINE key to enter Performance Editor Define.

To return to Performance mode, press the same key once again, or press the EXIT key.

■ Edit mode

```
#GLB-01[Tune & Transpose]>Master Tune  
440.0[Hz] Transpose+00 PostKbd
```

In this mode you can modify/create program sounds. The program parameters for editing programs are grouped in 10 sections. You can also make settings which affect the entire Prophecy.

To enter this mode from Performance mode, press the PERFORMANCE/EDIT Select key. To return to Performance mode, press the same key once again. The 10 sections in this mode are entered by pressing one of the OSC ~ GLOBAL keys. Each section is further divided into two or more pages or levels.

For details on each section, refer to page 23.

■ Pattern Define mode

```
#UP-1[Arpeggio Param]>Step Base  
StB: J Sort:ON SchZone[Dbt:C-1 Tr:G9 ]
```

In this mode you can set parameters for the arpeggiator, and also create user patterns.

Settings for preset patterns occupy 4 pages, and settings for user patterns occupy 6 pages. To enter Pattern Define mode, press the PATTERN DEFINE key from either of the above modes. To return to the previously selected mode, either press the same key again, or press the EXIT key.

3.2 Moving between modes

The following diagram shows how you can move between Performance mode and the other modes. If one key has an arrow pointing two directions, it will return to the previous mode.

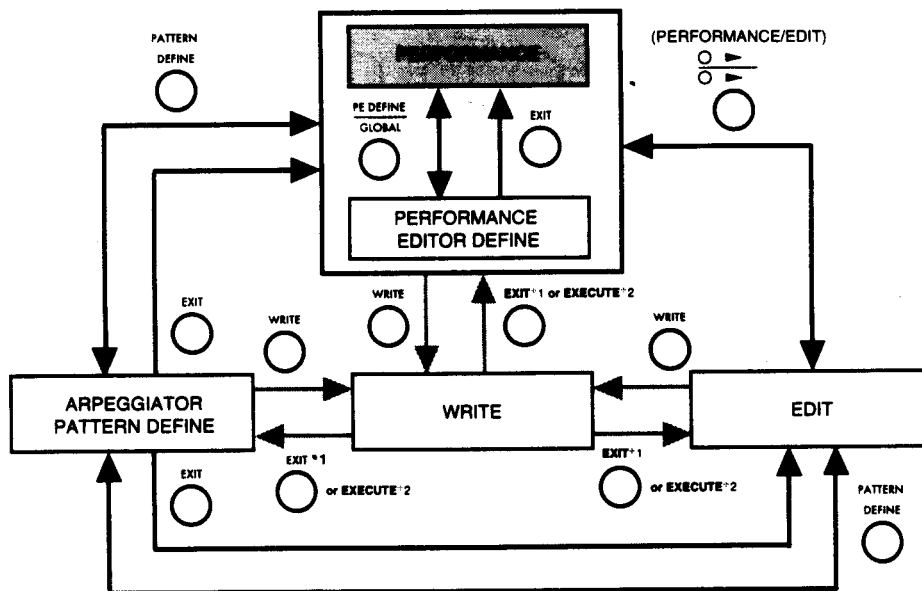

Example of moving between modes:

PERFORMANCE→PERFORMANCE EDITOR DEFINE→EDIT→ARPEGGIATOR PATTERN DEFINE→WRITE

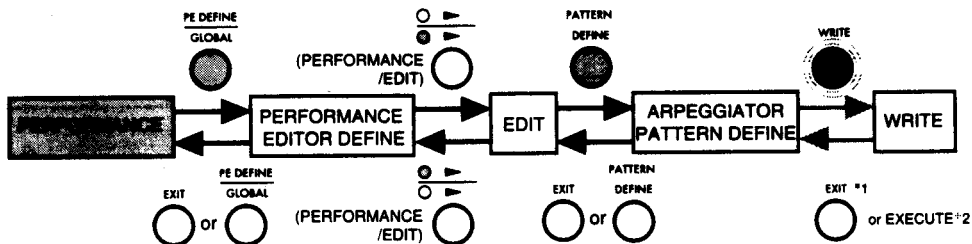

Example of moving between modes:

PERFORMANCE→ARPEGGIATOR PATTERN DEFINE→EDIT→WRITE

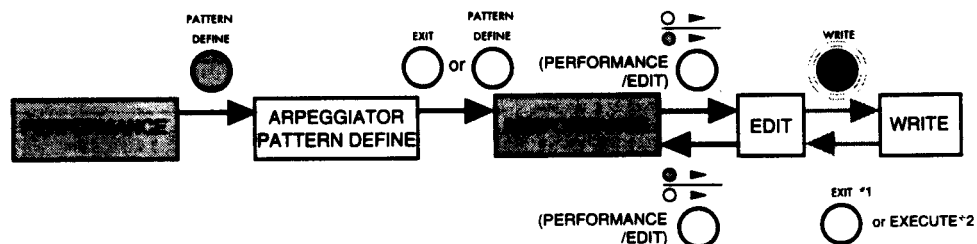

*1 If after finalizing the writing destination for a Write operation, you then decide to cancel and exit the Write operation, press the EXIT key twice (see page 31).

*2 When a Write operation is executed, you will return to the display that you were in before executing Write (see page 31).

3.3 Moving through the sections of Edit mode

1 Press the PERFORMANCE/EDIT Select key to enter EDIT mode. (The lower LED will blink.)

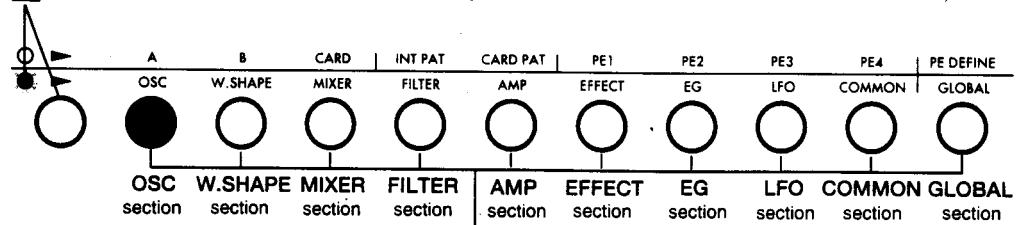

2 To enter a section, press the corresponding key. (The LED of the section key you pressed will light.) For details on each section, refer to page 23.

3.4 Moving between pages of Performance Editor Define, Pattern Define mode, and Edit mode

The PAGE RIGHT key advances to the next page, the PAGE LEFT key returns to the previous page. You can also jump to the first page by simultaneously pressing both the RIGHT and the LEFT keys.

Example: EDIT mode OSC section

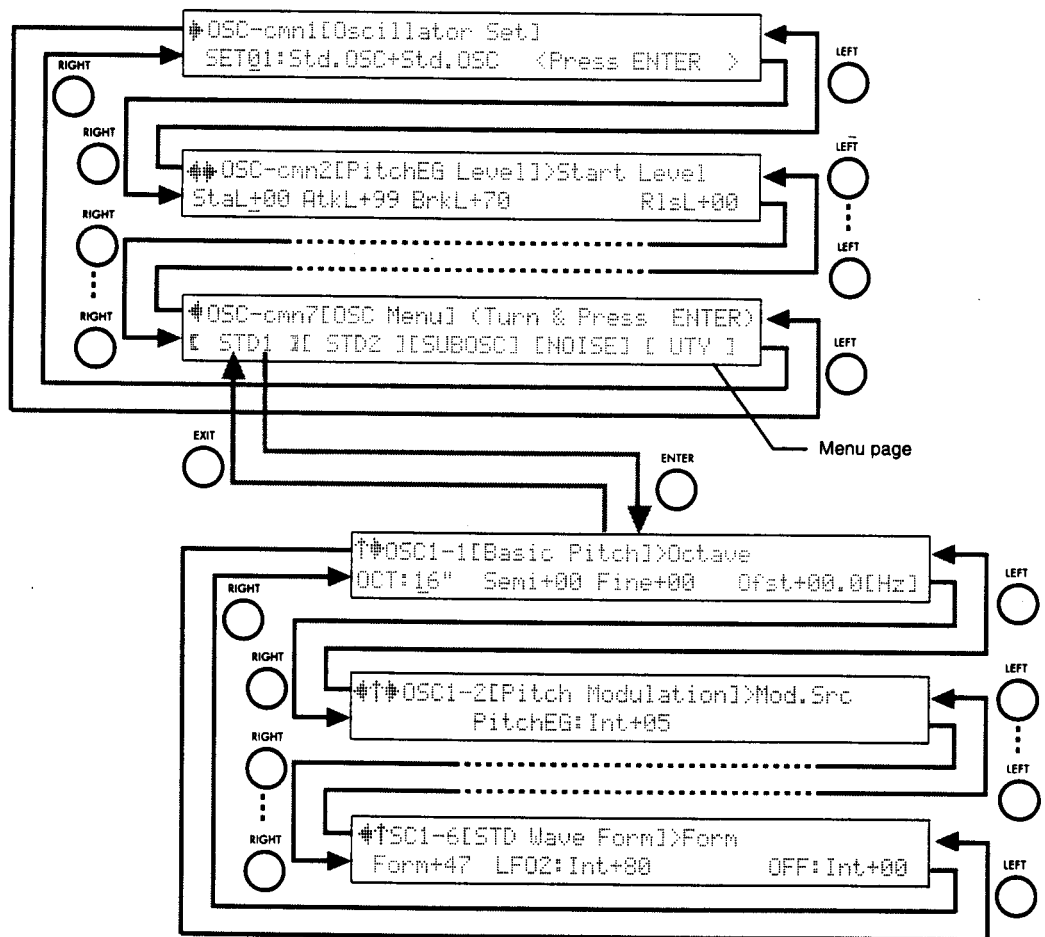

Several sections of Edit mode contain Menu pages, in which the lower line of the display shows items in square brackets [].

Additional pages are located under each menu item. Use the cursor keys or rotate the knob nearest the item you wish to select so that the display reads [], and press the ENTER key to enter the selected page. To go back up to the level above, press the EXIT key. There are no menu pages in Performance Editor Define or Arpeggiator Pattern Define modes.

3.5 Moving the cursor in Performance Editor Define, Pattern Define mode, and Edit mode

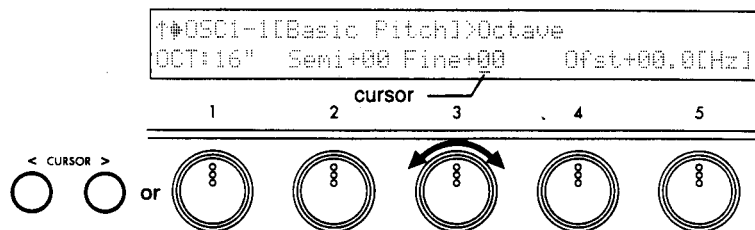

One page can contain up to five parameters. To move the cursor to the parameter you wish to edit, use the CURSOR < > keys or rotate the knob for that parameter. If you rotate the knob, be aware that the value of the parameter will also be affected.

3.6 Setting values in Performance Editor Define, Pattern Define mode, and Edit mode

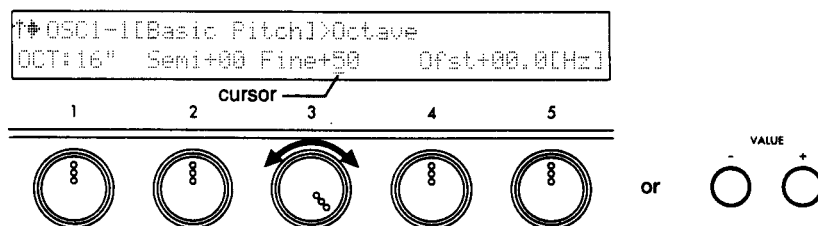

Rotate the knob nearest the parameter you wish to edit, and the value will change.

Press the VALUE +/- keys to modify the value of the parameter at the cursor in steps of +1/-1.

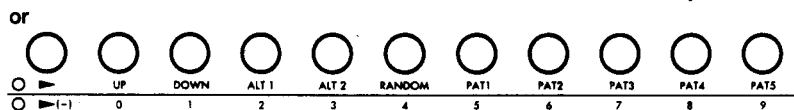

Use the numeric keys to enter a value for the parameter at the cursor. The numeral printed in the lower row below each key indicates the value that will be entered.

If the parameter value is a signed number (positive or negative), use the PATTERN/PROGRAM Select key to input positive (+) or negative (-) values.

If the range of values is within 0-9, a single press of a numeric key will finalize the input.

If the range of values is two or more digits, the place of the numeral will scroll as you enter more digits, and the value will be finalized when you press the ENTER key.



If the ENTER key LED blinks when you modify a value, press the ENTER key to finalize the value. To cancel the change, press the EXIT key.

3.7 About the screen display

■ Performance mode

If in Performance Editor Define or Edit mode you have modified a parameter value, the bank name of the modified program will be displayed in lower-case characters (a,b,c). When you Write the data into memory, this will return to the upper-case display.

For other aspects of the display, refer to "About the Performance mode display" (page 8) and "About the Performance Editor display" (page 11).

Lower-case display indicates that the program has been edited.

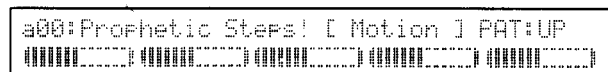

■ Performance Editor Define, Pattern Define mode, Edit mode

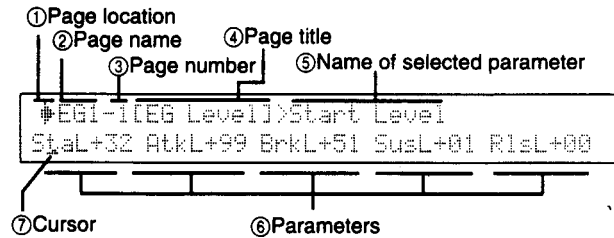

① Page location

: More pages exist to the right.

: More pages exist to the left.

↑ : Higher levels exist. This will appear in several sections of Edit mode. Press the EXIT key to return to the menu page (* 1) of the current section.

To move between pages, use the PAGE RIGHT and PAGE LEFT keys.

② Page name

The page name for Performance Editor Define is "PED".

The page name in Pattern Define mode will be the name of the currently selected pattern; e.g., "UP", "DOWN", "ALT1", "RAND", "PAT1", etc.

The page name in Edit mode will be the name of the currently selected section; e.g., "OSC", "WS", "FLT", "AMP", "FX", "EG", "LFO", "CMN", "GLB", etc.

③ Page number

④ Page title

This is the overall name for the parameters which make up this page.

⑤ Name of selected parameter

This displays the name of the parameter where the cursor is located; the parameter to which edits are being made. If the page contains only one parameter, this may not be displayed.

⑥ Parameters

Edit the values of these parameters using the VALUE keys, knobs 1~5, or the numeric keys.

⑦ Cursor

This is displayed under the selected parameter. The cursor can be moved to the desired parameter using the CURSOR < > keys or the corresponding knob. Be aware that using a knob to move the parameter will also affect the value of the parameter. The cursor is not displayed in menu pages (* 1).

About menu pages (* 1)

Pages in which the lower line of the LCD contain items in square brackets [] are menu pages. The items in the brackets are menu items. Use the CURSOR [] keys or rotate a knob to move to the desired item, and press the ENTER key to enter that level. Press the EXIT key to return to this menu page.

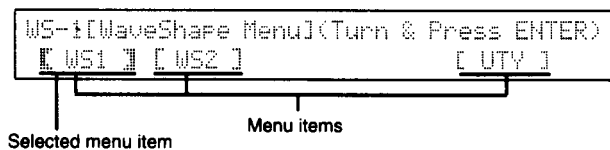

4 Edit

4. 1 How a program is organized

The programs of the Prophecy are organized as follows.

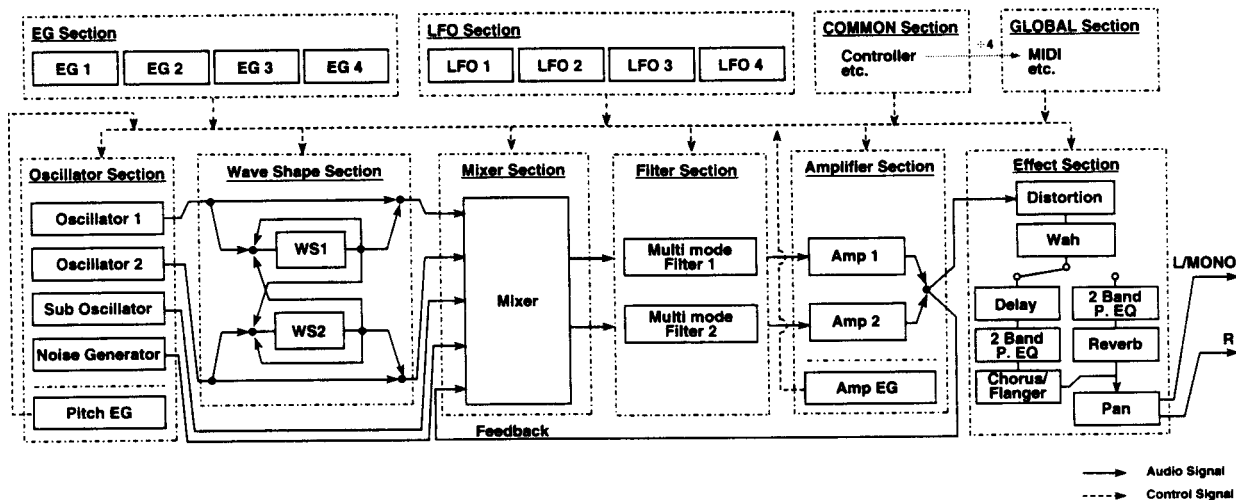

■ OSC (Oscillator) section

The Oscillator section creates the waveform, which is the most basic element determining the sound.

Oscillator 1

Oscillator 2

Seven types of tone generation (oscillator types * 1) are provided. You can select a combination of two oscillator types (an Oscillator Set * 2), and make settings that specify the basic pitch and other aspects of the oscillator.

Sub Oscillator

You can select one of 4 basic waveforms, and specify its pitch as an interval of semitones or cents from the basic pitch. The same pitch modulation effect that applies to the Oscillator will be applied to the Sub Oscillator. In the Mixer section, the signal of the Sub Oscillator is mixed with the signals from Oscillators 1 and 2.

Noise Generator

This generates white noise. The signal from the Noise Generator is mixed by the Mixer section, in the same way as the Sub Oscillator signal.

The OSC section also contains a pitch envelope generator (Pitch EG) used to control the pitch.

■ Wave Shape section

The Wave Shape section uses a non-linear table to modify the waveform. The signals from Oscillators 1 and 2 are routed through the Wave Shape section, allowing you to apply effects such as clipping or resonance to the signals.

■ Mixer section

The Mixer section mixes the signals from Oscillators 1 and 2, the Sub Oscillator, the Noise Generator, and feedback from the Amp section, and outputs the result to the Multi Mode Filters 1 and 2 (the Filter section).

■ Filter section

The Filter section modifies the waveform by attenuating or emphasizing specified frequency regions. This section contains two multi-mode filters. Each allows you to select the filter type (low pass, high pass, band pass, or band reject). The Filter section allows you to modify the overall brightness of the sound. You can also specify how the two filters will be connected to the Mixer section and the Amp section.

Serial1

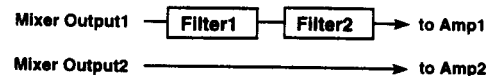

Serial2

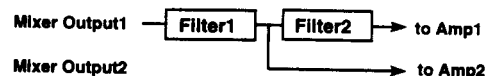

Parallel



■ AMP (Amplifier) section

The Amplifier section creates time-varying changes in the volume of the sound output from the Filter section. Two independent amps are provided, and the volume input to each amp will depend on how the filters are connected.

The Amplifier section also contains an amplitude envelope generator (Amp EG) for controlling the amp.

■ Effect section

The Effect section contains seven types of effect; Distortion, Wah, Delay + Chorus/Flanger, Reverb, and Dual Parametric EQ. Of these effects, you must select either Chorus/Flanger + Delay or Reverb (it is not possible to use both of these simultaneously).

■ EG section

This section provides four general purpose envelope generators (EG). These EGs can be used as modulation sources for parameters in each section (except for EG, Common, and Global sections), to apply time-varying changes to the sound.

■ LFO section

This section provides four LFOs. These LFOs can be used as modulation sources for parameters in each section (except for EG, Common, and Global sections), to apply cyclical change to the sound.

■ Common section

This section contains parameters such as program name, and settings for the keyboard and controllers (WHEEL 1/2/3, RIBBON, etc.).

■ Global section

This section contains settings that affect the entire Prophecy, such as tuning and MIDI-related settings.

■ *1 Oscillator types

Standard Oscillator

This simulates the oscillator of an analog synthesizer. You can achieve the same effects as on an analog synthesizer, such as Pulse Width Modulation.

Noise + Comb Filter

This oscillator extracts a pitched component from white noise. It can create not only unique sounds, but also a wide variety of sounds ranging from string-type sounds to synth bass.

VPM (Variable Phase Modulation)

This modulates the phase of two oscillators and uses the wave shaping table to process the sound to create rich overtones.

Cross/Sync/Ring Modulation

This oscillator simulates the inter-modulation between oscillators that was possible on analog synthesizers.

Brass Model Oscillator*3

This oscillator provides a physical model simulation of lip reed brass instruments such as trumpet and trombone.

Reed Model Oscillator*3

This oscillator provides a physical model simulation of reed instruments such as a saxophone.

Plucked String Model Oscillator*3

This oscillator provides a physical model simulation of plucked string instruments such as a bass guitar.

■ *2 Oscillator Sets

Set	Oscillator 1	Oscillator 2
Set 1	Standard OSC	Standard OSC
Set 2	Standard OSC	Comb Filter OSC
Set 3	Standard OSC	VPM OSC
Set 4	Standard OSC	Modulation OSC
Set 5	Comb Filter OSC	Comb Filter OSC
Set 6	Comb Filter OSC	VPM OSC
Set 7	Comb Filter OSC	Modulation OSC
Set 8	VPM OSC	VPM OSC
Set 9	VPM OSC	Modulation OSC
Set 10	Brass OSC	no oscillator
Set 11	Reed OSC	no oscillator
Set 12	Pluck OSC	no oscillator

*3 The Brass Model Oscillator, Reed Model Oscillator, and Plucked String Oscillator use physical models. Unlike conventional oscillators which produce a fixed waveform, physical models simulate the physical characteristics of the components that make up an instrument, such as the bore, reed, or string. For example, a physical model might calculate the way in which a pressure wave would be reflected and attenuated as it passed through a bore, or the way in which a reed moves when air is blown past it. These calculations are made in realtime to determine what sound would result.

*4 In order to use the controllers of the Prophecy to control its own tone generator or an external MIDI device, you need to specify how the Prophecy's controllers correspond to control messages such as pitch bender, aftertouch, and control changes #00~95. These settings are made in the Common section of each program. In the Global section, you can specify how the MIDI messages assigned to the Prophecy's controllers will be transmitted and received.

4.2 Editing a program

This section explains the procedure for editing a program.

* In these explanations we are modifying parameter values using only the knobs, but for making fine changes it is more efficient to use the VALUE keys.

■ Initializing a program

The programs of the Prophecy consist of a complex combination of settings. In order to help you understand the procedure for creating a program, we will initialize a program to the simplest possible settings as follows.

- 1** Press the PERFORMANCE/EDIT Select key to enter Edit mode (the lower LED will blink).
- 2** Press the COMMON key to enter the Common section. Use the PAGE keys to move to page CMN-10 [Initialize Program].
- 3** Press the ENTER key. You will be asked <Are you sure?> Press the ENTER key once again. The program will be initialized, and the display will indicate <COMPLETED>.

Now play the keyboard. You will hear a simply sawtooth wave.

■ Oscillator settings

The oscillator is the section that creates the "waveform", which is the most basic element of the sound. The Prophecy is able to produce a wide variety of waveforms, but in this example we will use the most basic Std.OSC in the following explanation of the sound-editing procedure.

- 1** Press the OSC key to enter the OSC section. Use the PAGE keys to move to page OSC-cmn1 [Oscillator Set].
Make sure that the display indicates "SET01:Std.OSC+Std.OSC". This means that Std.OSC is assigned to both OSC1 and OSC2.
- 2** Use the PAGE keys to move to page OSC-cmn7 [OSC Menu]. Move the knob located below the [STD1] display so that it reads [STD] , and press the ENTER key. You will move to page OSC1-1 [Basic Pitch].
The four parameters shown in this page specify the pitch of OSC1. As you play the keyboard, modify the parameters and notice how the pitch changes.
- 3** Use the PAGE keys to move to page OSC1-5 [STD WaveLevel]. Use knob 1 located below the "SAW" display, and change it to "PULSE". Play the keyboard and notice that the waveform has been changed from sawtooth to pulse.
- 4** Use the PAGE keys to move to page OSC1-6 [STD Wave Form]. While playing the keyboard, rotate knob 3 located at the lower right of the "LFO2:Int+00" display. Notice that the sound begins to "waver". This is because LFO2 is being used to vary the width of the pulse wave. For this example, set it to "Int+50".
- 5** Now we will modify the setting of the LFO2 that we heard in step **4** . Press the LFO key to move to page LFO-1 [LFO Menu]. Rotate knob 2 located under the [LFO2] display, so that it reads [LFO2] , and press the ENTER key. Next use the PAGE keys to move to page LFO2-2 [Frequency]. Rotate knob 1 located under the "040(1.050[Hz])" display. Notice that the frequency of the "wavering" changes. For this example, set it to "031(0.800[Hz])".

Filter settings

The filter is the section that processes the waveform produced by the oscillator. The tone color will change dramatically depending on the settings of the filter. The Prophecy provides two filters, and since each allows you to freely adjust the tonal character, a wide variety of possibilities are available. Let's try them out and hear how the filters work.

- 1 Press the FILTER key to enter the Filter section page FLT-1 [Filter Menu]. Make sure that the display indicates "Routing:SERIAL1". This means that Filter 1 and Filter 2 are connected in series.
- 2 Let's adjust the settings of filter 1. Rotate knob 3 located under the [FILTR1] display to make it read [FILTR1], and press the ENTER key. Use the PAGE keys to move to page FL1-1 [Type & Input]. Rotate knob 2 located under the "Filter Type:THRU" display so that it reads "Filter Type:LPF". Play the keyboard and notice that the high frequency range is slightly attenuated. This is the result of using filter 1 as an LPF (low pass filter).
- 3 Use the PAGE keys to move to page FL1-2 [Cutoff]. Rotate knob 1 located below the "Fc:50" display. Notice that as the value is increased the sound becomes brighter, and as it is decreased the sound becomes darker. This is the result of changing the upper limit of the frequencies which pass through the filter (the cutoff frequency). For this example, set "Fc:80".
- 4 Use the PAGE keys to move to page FL1-3 [Resonance]. Rotate knob 1 located below the "Reso:50" display and change it to about "Reso:80". Notice how the sound changes. This is the result of emphasizing the area in the region of the cutoff frequency you set in step 3.
- 5 Now we will use the EG (envelope generator) to modify the cutoff frequency. Press the EG key to move to page EG-1 [EG Menu]. Rotate knob 3 located under the [EG3] display so that it reads [EG3], and press the ENTER key.

- 6 Use the PAGE keys to move to page EG3-1 [EG Level]. Rotate knobs 1~5 to make the following settings. (There is no need for the values to be exact. Just set them approximately.)

StaL+00 AtkL+99 BrkL+70 SusL+50 RlsL+00

- 7 Use the PAGE keys to move to page EG3-2 [EG Time]. In the same way, rotate knobs 1~5 to make the following settings.

AtkT:20 DcyT:30 SlpT:50 RlsT:40

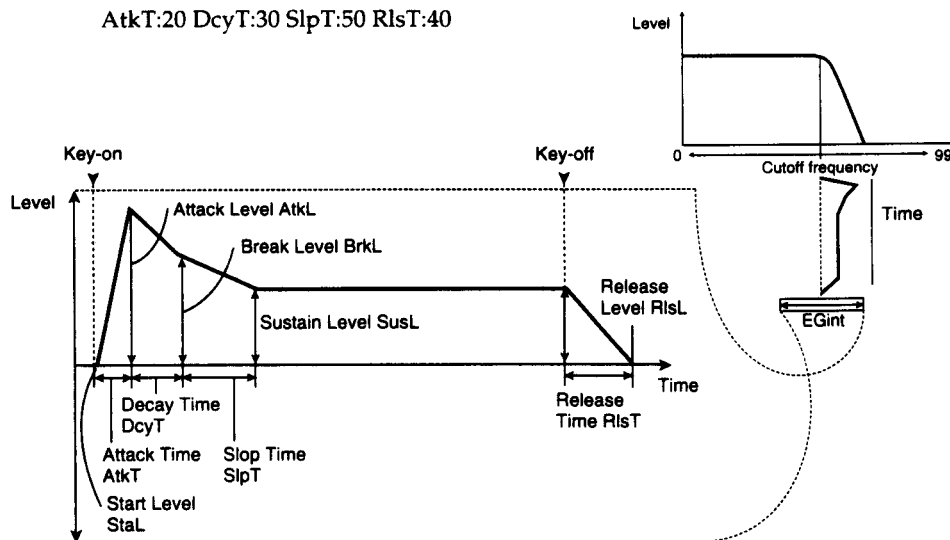

- 8 Press the FILTER key, and use the PAGE keys to move to page FL1-2 [Cutoff]. Rotate knob 1 located under the "Fc:80" display so that it reads about "Fc:10". Next rotate knob 3 located under "EG3:Int+00" so that it reads "EG3:Int+90". Play the keyboard and notice that the cutoff frequency changes.

■ Amp settings

The Amp section creates changes in volume over time. By “volume changes,” we are talking about how the sound begins either quickly or gradually when you play a note. Follow the procedure below to hear how it works.

- 1 Press the AMP key to move to the Amp section. Next rotate knob 3 located under the [AMPEG] display so that it reads [AMPEG], and press the ENTER key. Use the PAGE keys to move to page AEG-1 [Amp EG Level], and make the following settings.

StaL:00 AtkL:99 BrkL:60 SusL:80

- 2 Use the PAGE keys to move to page AEG-2 [Amp EG Time], and make the following settings.

AtkT:20 DcyT:30 SlpT:50 RlsT:30

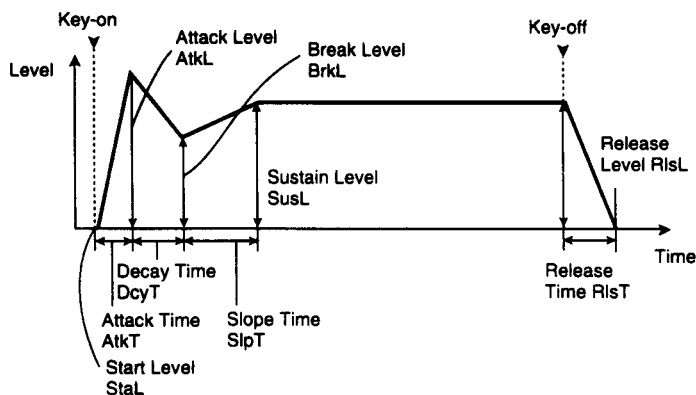

Notice that the attack of the sound has become softer. The attack is changed by modifying “AtkT:20”. Modify the value and notice how the attack changes. Try modifying other parameters and see how the Amp section works.

■ Using effects

The Prophecy provides a variety of effects. Here we will give a simple explanation of the chorus/flanger and delay.

- 1 Press the EFFECT key to enter the Effect section. Use the PAGE keys to move to page FX-2 [Delay/Reverb]. Rotate knob 1 to select “Type:CHORUS&DELAY”.
- 2 Rotate knob 4 located under [CH/FL] so that it reads [CH/FL], and press the ENTER key. Use the PAGE keys to move to page CHFL-3 [Fx Balance]. Rotate knob 1 located below “Bal:000%” so that it reads approximately “Bal:050%”. Notice how the chorus effect sounds.
- 3 Now let's try the delay. Press the EXIT key. Make sure that you are in page FX-2 [Delay/Reverb]. Rotate knob 3 located below [DELAY] so that it reads [DELAY], and press the ENTER key. Use the PAGE keys to move to page DLY-2 [Fx Balance]. Rotate knob 1 located below “Bal:000%” to make it read approximately “Bal:020%”. Notice how the delay effect sounds.

■ Setting and using controllers

The Prophecy has a variety of controllers; Wheel 1-3, Ribbon Controller, Foot Pedal, Foot SW etc. For each program you can freely assign the function of each controller, to control the sound in the most suitable way.

In an initialized program, the controllers are assigned as follows.

Wheel1	Pitch Bend+ -
Wheel2	Control Change 1
Wheel3+	Control Change 2
Wheel3-	Control Change 3
RibbonX	Control Change 16
RibbonZ	Control Change 17
FootPedal	Control Change 18
FootSW	Sustain (Control Change 64)

Let's make some changes to these settings.

- 1** Press the COMMON key, and use the PAGE keys to move to page CMN-5 [Wheel 1/2 Assign]. Rotate knob 1 to modify the function assigned to Wheel 1. For this example, set Wheel 1 OFF. Move Wheel 1 and notice that the Pitch Bend effect does not occur.
- 2** Use the PAGE keys to move to page CMN-7 [Ribbon Assign]. Move knob 1 to change the Ribbon X setting to Pitch Bend+ -. Move your finger over the Ribbon Controller to left and right, and notice how the pitch bend effect is applied. Moving from the center toward the right end of the ribbon will raise the pitch, and moving toward the left will lower the pitch.
- 3** Rotate knob 3 to set XVC:ON. With this setting, the location where you first place your finger on the ribbon will be the zero point of the controller value. Operate the ribbon and notice the result.
- 4** Use the PAGE keys to move to page CMN-6 [Wheel 3 Assign]. Notice that the settings are "+:007(CChg#02)" and "-:008(CChg#03)". This means that moving the wheel upward will transmit control change #2, and moving it downward will transmit control change #3. Let's use this to control the sound. First press the FILTER key, and use the PAGE keys to move to page FLT1-5 [Fc Modulation]. Rotate knobs 3 and 4 to make a setting of "CChg#02:Int+20". Raise Wheel 3 upward, and the cutoff frequency of Filter 1 will change. Next, press the MIXER key, and use the PAGE keys to move to page MIX-7 [NOISE → OUT1]. Rotate knobs 1, 2, and 3 to make settings of "Lvl:00" and "CChg#3:Int+50". Move Wheel 3 downward, and notice that noise is mixed into the sound. Try operating the Ribbon Controller and Wheel 3 at the same time to modify the pitch and tone.

The examples above demonstrate only a small fraction of the possibilities of the Prophecy. For details on its other functions, refer to the separate Parameter Guide.

4.3 Saving a program

Programs can be saved in bank A 00-63, bank B 00--63, and if a writable card is inserted, bank CARD 00~63. In Performance mode, changes you make to the sound using the Performance Editor, and the on/off status of the PORTAMENTO key can be saved for each program. Each program also contains the settings made in Edit mode (except for the Global section settings) and all settings of Performance Editor Define. These settings are not saved in memory unless you perform the Write operation. In the Edit mode Global section, changes you make are saved at the moment they are modified, so there is no need to Write them into memory.

Ten arpeggio patterns can be saved in bank INT PAT, and if a writable card is inserted, the CARD PAT bank can accommodate ten more patterns. However, it is not possible to write directly into the CARD PAT bank. The UP, DOWN ALT1, ALT2 and RANDOM patterns can save arpeggio parameters. PAT1-PAT5 can save arpeggio parameters and also pattern parameters. As with the Edit mode Global section parameters, this data is saved at the moment it is modified, so there is no need to Write them into memory.

To write a program, press the WRITE key from any mode or condition.

■ Memory protect

To help prevent data from being inadvertently overwritten, the Global section contains a memory protect setting. Before writing data that you create, you must turn off the memory protect setting in the Global section.

- 1** Press the PERFORMANCE/EDIT Select key to enter Edit mode (the lower LED will blink).
- 2** Press the GLOBAL key to enter the Global section. Use the PAGE keys to move to page GLB-20 [Memory Protect].
- 3** If you wish to edit and write a program, rotate knob 2 to turn Program Memory OFF. If you wish to edit arpeggio parameters, rotate knob 4 to turn Pattern Memory OFF.

** When you write data, the data that was previously in the writing destination will be lost. However, you can use Global section page GLB-19 [Load FactoryData] to restore the sounds that the Prophecy was shipped with. Global section settings and arpeggio parameter settings can also be restored to the factory settings.*

■ Rename

Here's how to assign a new name to a program you have edited.

- 1** Press the PERFORMANCE/EDIT Select key to enter EDIT mode (the lower LED will blink).
- 2** Press the COMMON key to enter the Common section. Use the PAGE keys to move to page CMN-1 [Program Name].
- 3** Press the CURSOR keys or rotate knob 4 and make sure that the cursor appears. When the cursor appears, you can modify the character at the location of the cursor.
- 4** Use the CURSOR keys or knob 4 to move the cursor, and use the VALUE keys or knob 5 to select a character. At this time you can press the ENTER key to input a space, or the EXIT key to delete a character.
- 5** Use the PAGE keys to move to page CMN-2 [Prog Category]. Use knob 1 to select the program category.
The Program Category allows you to classify your programs by sub-name or type of sound. The Program Category is displayed at the right of the program name in Performance mode. When selecting programs in Performance mode, you can use the PAGE keys to find and select programs that have the same category.

■ Writing procedure

1 Press the WRITE key.

The WRITE key LED and the bank LED of the writing destination will light, and the LEDs of the available banks and the ENTER key LED will blink.

The display will indicate the current program parameter load source in the upper line, and the writing destination in the lower line.

```
a00:[Prophetic Steps!]>will save as  
->A00:(Prophetic Steps!) <Press ENTER >
```

* If memory protect is ON, an error message will be displayed. Press the EXIT key to return to the previous display. Set the Edit mode Global section, page GLB-20 [Memory Protect] parameter to OFF.

• If you wish to return to the display you were in previously, press the EXIT key.

2 Using the A, B, or CARD*1 keys, specify the writing destination bank.

*1 If the CARD key LED is unlit, pressing the CARD key will produce an error message. If you wish to write into the CARD bank, you must set the write protect slider of the card to the OFF position before inserting it into the card slot.

3 Use the VALUE keys, numeric keys, or knob 1 to specify the writing destination program number.

4 To confirm the writing destination program number you specified in steps 2 and 3, press the ENTER key.

The following display will appear, and the ENTER key LED will blink faster.

```
a00:[Prophetic Steps!]>will save as  
->A00:(Prophetic Steps!) <Are You Sure?>
```

• To cancel, press the EXIT key. If you then press the EXIT key once again, you will return to the display you were in before initiating the Write operation.

5 If you are sure that you want to write the data, press the ENTER key. The data will be written.

When execution is complete, you will return to the display you were in before initiating the Write operation.

• If you decide to cancel the Write operation, press the EXIT key. You will return to the display of step 1. If you then press the EXIT key once again, you will return to the display you were in before initiating the Write operation.

4.4 Compare

By pressing this key during editing, you can recall the unedited settings. The data being edited will be held in internal memory until the next time you edit. When you press this key once again, the edited data will be recalled. Be aware that if you edit parameters while the LED of the COMPARE key is lit, you will lose the edits that you made before pressing the COMPARE key.

If you enter Performance mode without writing your edited data, the bank name shown in the upper left of the display will appear in lower-case characters. As long as you do not change programs, the COMPARE key will still act as explained above.

Even if you return to Performance mode without writing your edited data and then select another program number, you will still be able to recall your edited data. Press the COMPARE key and the bank name (of Performance mode) will change to lower-case characters, and the edited data will be recalled. Press the key once again and the LED will go out, and the currently selected program number will be recalled.

If you write the edited data, the Compare function will not be available.

4.5 Performance Editor assignments (Performance Editor Define)

For each program in Performance mode, you can assign program parameters to knobs 1-5 for realtime control of the sound. For each program you can make four sets of Performance Editor settings. These settings are made in Performance Editor Define. In the following pages, the explanation will continue the procedure given in "4.2 Editing a program," using the program you initialized and then modified. The initialized program has the following settings.

PE	KNOB No.	Assign Parameter	Knob Left	Knob Right	Curve
	KNOB1	OSC1_Octave	000%	100%	LINER
	KNOB2	Std1_Wave	000%	100%	LINER
PE1	KNOB3	Std1_RampLevel	000%	100%	Exp
	KNOB4	Std1_WaveForm	000%	100%	Exp
	KNOB5	Delay_Balance	000%	70%	Exp
	KNOB1	OSC2_Octave	000%	100%	LINER
	KNOB2	Std2_Wave	000%	100%	LINER
PE2	KNOB3	Std2_RampLevel	000%	100%	Exp
	KNOB4	Std2_WaveForm	000%	100%	Exp
	KNOB5	Chorus_Balance	000%	70%	Exp
	KNOB1	Filter1_Fc	000%	100%	LINER
	KNOB2	Filter1_Resonance	000%	90%	LOG
PE3	KNOB3	Filter1FcEGInt	000%	100%	LINER
	KNOB4	EG3_AttackTime	000%	100%	LINER
	KNOB5	EG3_DecayTime	000%	100%	LINER
	KNOB1	Filter2_FC	000%	100%	LINER
	KNOB2	Filter2_Resonance	000%	90%	LOG
PE4	KNOB3	Filter2FcEGInt	000%	100%	LINER
	KNOB4	EG3_AttackLevel	000%	100%	LINER
	KNOB5	EG3_Break Level	000%	100%	LINER

- 1** From Performance mode, press the PE DEFINE key.
The PE DEFINE key LED will light, and you will enter Performance Editor Define. The PE key being edited will blink.
- 2** Use the PAGE keys to move to PED-1 [PE1 Definition]. Here you can specify the parameters that will be controlled by each knob for PE1. Rotate knob 1 and check that #1~#5 are set as shown in the PE1 area of the above table.
These settings determine which parameters will be assigned to each knob when PE1 key is pressed.
- 3** Rotate knob 2. Notice how the assigned parameter changes. Here you can select the parameter that will be assigned to the knob.
The display shows an abbreviation of the parameter name that would be displayed fully in Edit mode. For the correspondence between the abbreviation and the full parameter name, refer to the "Performance Editor Assign List" in the appendix of the separate "Parameter Guide." The percentages shown in brackets indicate the value relative to the range of the values that can be set in Edit mode.
- 4** Rotate knob 3. This setting specifies the effect produced by moving the knob to the far left position in Performance mode. Listen to the effect on the sound as you modify the value. Knob 4 specifies the effect produced by moving the knob to the far right position in Performance mode. Set the value in the same way. Use the CURSOR < key to return to the Assign Parameter that you set in step **3**. Notice that the sound changes here as well. This is because the assigned parameters have returned to the values of their settings.
- 5** The indication of "LINEAR" at the right allows you to select one of three curves that will determine how the sound changes when you operate the knob selected in **4**.

This completes settings for PE1. Use the PAGE keys to move to PED-2~PED-4, and make settings for PE2~PE4.

4.6 Arpeggio Pattern settings (Pattern Define)

Each arpeggio pattern contains arpeggio parameters that specify how arpeggiation is performed. Let's try modifying these settings.

* When you modify parameter values in Pattern Define mode, the modified settings are saved in memory as you make them.

- 1 Set the arpeggio pattern to UP, and turn on the arpeggio ON/OFF key and turn off the OCTAVE LED.
- 2 Press the PATTERN DEFINE key to make the LED light. Now you can make arpeggio parameter settings.
* PATTERN DEFINE mode doesn't work by the Bank CARD PAT. Select the Bank INT PAT.
- 3 Use the PAGE keys to move to the UP-1 [Arpeggio Param] page. Notice the setting of StB: ♩ . This means that a Step Base of a eighth note will be used to arpeggiate the notes. Rotate knob 1 to modify this setting. This will affect the interval of the arpeggio notes.
- 4 Notice the setting of Sort:ON. This means that the notes you press on the keyboard will be sorted from lowest note to highest note before arpeggiation. Play a chord and notice that the arpeggio is played from low to high note. Rotate knob 2 to set this to Sort:OFF, and play a chord again. This time the notes of the arpeggio will be played in the order that you press them.

for Pattern Up



If you play notes in the order of
C3 → G3 → E3 → B3 ...



Sort: ON



Sort: OFF



- 5 Use the PAGE keys to move to the UP-2 [Velocity Param] page. Notice the setting of Vel:KEY. This means that the velocity of the arpeggiated notes will depend on the velocity with which you played the notes on the keyboard. Play a chord with notes of different velocity, and notice how the arpeggio playback changes. Rotate knob 1 and make a setting of Vel:001~127, and the arpeggio will be played with a constant velocity regardless of strongly you played the keyboard.
- 6 Use the PAGE keys to move to the UP-3 [Gate Param] page. Notice the setting of Gt:80%. This means that the length (gate time) of the arpeggio notes will be 80% of the length of the Time Base. Rotate knob 1 to modify the setting in the range of Gt:001~100%, and notice how the gate time changes.
- 7 The velocity and gate time of the arpeggio notes can be controlled by the various controllers while you play. Select the controller that you wish to use in the Global section page GLB-6 [Arpeggio Controller]. Press the PATTERN DEFINE key. Next press the PERFORMANCE/EDIT key to make the lower LED blink. Press the GLOBAL key to enter the Global section. Use the PAGE keys to move to GLB-6.
With the factory settings, velocity will be controlled by Control Change #24, and gate time will be controlled by Control Change #25. Use knob 2 to set "Vel:ATouch" and use knob 4 to set "Gate:ATouch". Press the PATTERN DEFINE key to make the LED light. Use the PAGE keys to move to UP-3 [Gate Param], and use knob 1 to set "Gt:20%" and knob 3 to set "Int+99". Hold down the notes on the keyboard that you wish to arpeggiate, and then press down on the keyboard more firmly to modify the gate time.
- 8 Now let's change the velocity of the arpeggio notes. So that the effect will easy to notice, reset UP-3 [Gate Param] to "Gt:80%" and "Int+00". Then use the PAGE keys to move to the UP-2 [Velocity Param] page. Use knob 1 to set "Vel:020" and use knob 3 to set "Int+99". As you did earlier, play a chord and then play harder on the keyboard to notice how the velocity of the arpeggio notes will change.

4.7 Creating Pattern parameters (Pattern Define)

Now let's try creating an arpeggio pattern as shown in the following musical example.

* When you modify a parameter value in Pattern Define mode, the settings are stored as soon as you make them.

When the following notes are pressed



- 1** Return to Performance mode. Press a PAT1 key to select a user pattern. Press the PATTERN DEFINE key once again to turn on the LED and enter Pattern Define mode. If an arpeggio is playing, press the ARPEGGIO ON/OFF key to stop playback.
- 2** Use the PAGE keys to move to PAT1-1 [Arpeggio Param], and use knob 1 to set "StB: ♩" and knob 2 to set "Sort:ON".
- 3** Use the PAGE keys to move to PAT1-5 [Step Param]. The "St#01" parameter at left indicates the step number of the pattern. Each user pattern can contain up to 24 steps, and the arpeggiator will play each note from the first step at intervals of the step base. You can use the knob to move through the steps St#01~24 to check the settings of each step. The "Tone:XX" parameter specifies which of the notes being pressed will be sounded. A setting of "Tone:01" specifies the lowest note. (However this is in the case of Sort:ON. If Sort:OFF, this will refer to the note that was first pressed on the keyboard.) "Vel:XXX" and "Gt:XXX%" indicate the velocity and gate time of each step. The "Ofst+XX%" parameter is an offset that allows you to move the timing of each note backward or forward relative to the step base.

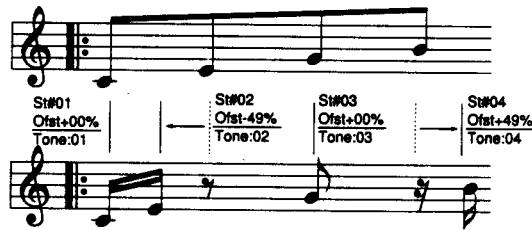

- 4** Here's how to specify the first step. Rotate knob 1 to select St#01, and rotate knob 2 to select Tone:01. In the same way, make settings for St#02~St#09 as follows.

St#01	Tone:01	Vel:100	Gt:080%	Ofst+00%
St#02	Tone:02	Vel:100	Gt:080%	Ofst+00%
St#03	Tone:03	Vel:100	Gt:080%	Ofst+00%
St#04	Tone:02	Vel:100	Gt:080%	Ofst+00%
St#05	Tone:04	Vel:100	Gt:080%	Ofst+00%
St#06	Tone:02	Vel:100	Gt:080%	Ofst+00%
St#07	Tone:03	Vel:100	Gt:080%	Ofst+00%
St#08	Tone:02	Vel:100	Gt:080%	Ofst+00%
St#09	Tone:LOOP	Vel:100	Gt:080%	Ofst+00%

The setting of "Tone:LOOP" for step St#09 causes the arpeggiation to return to the first step at this point.

- 5** Press the ARPEGGIO ON/OFF key to make it light, and press the C - E - G - B notes on the keyboard.
The phrase of the above musical example will be played.
- 6** Make changes to the velocity, gate time and offset settings of each step, and listen to the result.
Make sure that PAT1-2 [Velocity Param] is set to Vel:STEP, and that PAT1-3 [Gate Param] is set to Gt:STEP. With these settings, velocity and gate time will be determined by the settings for each step.

4.8 Other settings (Edit)

■ Loading factory preset data

If after modifying the program and arpeggio pattern settings you decide to bring back the factory settings, use Edit mode Global section page GLB-19 [LoadFactory Data] to recall the initial data. You can initialize a single program, or all programs, arpeggio patterns, and Global settings at once (Parameter Guide, page 148).

When you recall the factory settings, any settings that had been previously made will be lost. If necessary, save your data before initializing.

■ Saving data

Edited data can be saved using the Write operation. However for some parameters, the modified values are saved immediately without the need for the Write operation (page 30).

The programs of bank A or B and the arpeggio patterns of bank INT PAT can be saved by copying them to an optional SRC-512 RAM Memory Card. This is done in Edit mode Global section page GLB-17 [Save to Card] (Parameter Guide, page 145).

You can also save data by connecting a sequencer or data file capable of saving MIDI data to the MIDI connectors, and using Edit mode Global section page GLB-18 [MIDI DataDump] to select and transmit the data that you wish to save (Parameter guide, page 146).

■ Initializing, Copying, or Exchanging data within a section of the same program

It is possible to initialize, copy, or exchange (swap) data within sections of a program. This can help you create sounds more efficiently. You can also initialize or copy PE Define settings.

To initialize an entire program, use Edit mode Common section page CMN-10 (page 27).

■ Initializing

This operation resets all settings of the Prophecy to the factory settings. When this is done, all program sounds, arpeggio patterns, and settings (Global section) will also return to the factory settings. Be aware that since the controllers will return to an un-adjusted state, you will need to use GLB-22 [Controller Calibration] to re-adjust them.

You can also initialize by using Edit mode Global section page GLB-19 [Load FactoryData] and selecting "ALL_Data", but this will not initialize the settings such as Controller Calibration, etc. (Parameter Guide, page 148).

- To initialize, turn the power on while holding down the EXIT key and the VALUE+ key.

■ Adjusting the controllers

The active range of the WHEEL 1/2/3, RIBBON X/Z, After Touch, and Foot Pedal controllers can be adjusted. For WHEEL 1 and 3, you can also adjust the center.

* These settings are made in Edit mode Global section, page GLB-22 [Controller Calibration] (Parameter Guide, page 149). For RIBBON Z, adjust the sensitivity of the ribbon controller using the RIBBON SENSE knob located on the rear panel, and make fine adjustments using Edit mode Global section, page GLB-4 Ribbon Z Sense (Parameter Guide, page 136). After Touch can be adjusted by the After Touch Sense parameter located in the same page as GLB-4 After Touch Sense (Parameter Guide, page 136).

5 MIDI applications

MIDI (Musical Instrument Digital Interface) is a world-wide standard that allows electronic musical instruments and computers to exchange musical data.

5.1 MIDI channels

MIDI channels are similar to television channels in that when the channel of a receiving device is set to match the channel of a transmitting device, the data of that channel will be received.

The Prophecy sends and receives data on its specified Global MIDI channel. The Global MIDI channel setting is made in Edit mode Global section page GLB-8 [MIDI] Global Channel.

5.2 Note On/Off

When you play a note, a Note On message [9n,kk,vv] is transmitted which tells which note was pressed (the Note Number), how strongly it was pressed (the Velocity). (n:channel, kk:note number, vv:velocity) When you release the note, a Note Off message [8n,kk,vv] is transmitted.

The Prophecy transmits Note On/Off messages on the Global MIDI channel when you play its keyboard. However, if the Prophecy is set to Omni ON, it will receive and produce sound in response to incoming Note On/Off messages of any channel, regardless of its Global MIDI channel setting. Normally you will leave Omni OFF (Global mode GLB-8 Omni), so that Note On/Off messages will be received only on the Global MIDI channel.

5.3 Selecting programs

Programs can be selected by Program Change messages [Cn,pp] (pp: program number, up to 128 sounds can be selected). You can select programs of other banks by using Bank Select¹ messages [Bn,00,mm] (control change #00) and [Bn,20,bb] (control change #32). (mm: upper byte of bank number, bb: lower byte of bank number, together they allow you to select from 16384 banks.) An incoming Bank Select message will change the program bank from which subsequent program changes will be taken; i.e., the bank will not actually change until the next program change message is received. Normally the Prophecy will receive program change messages on its Global MIDI channel to change programs.

Program change messages are transmitted and received only when in Performance mode.

Transmission and reception of program change messages can be turned on/off in Edit mode Global section page GLB-12 [MIDI Program Change]. You can also specify the correspondence between the Prophecy's internal programs (A00-C63) and the program number / program bank of external MIDI devices. (Edit mode Global section page GLB-13 [Program Bank Select Map] and page GLB-14 [Program No. Select Map].

^{*1} When only Program Change messages are used to select sounds via MIDI, only 128 different sounds can be selected. If you need to select more than 128 sounds, use Bank Select messages. Control Change 0 specifies the upper byte of the bank number, and Control Change 32 specifies the lower byte. This provides a total of 16384 program banks. When a bank select message is received, the next-received Program Select message will select a program from the newly specified bank.

When selecting sounds from a MIDI sequencer, send Control Change 0 as the MSB, Control Change 32 as the LSB, and then a Program Change message. The result of receiving these messages will depend on the settings of Global section page GLB-13 [Program Bank Select Map] and GLB-14 [Program No. Select Map].

5.4 Bank Select

Refer to "5.3 Selecting Programs."

5.5 Applying aftertouch*2

The capability of modifying the sound by pressing down on the keyboard after playing a note is known as Aftertouch. When you apply aftertouch on the keyboard of the Prophecy, Channel Pressure messages [Dn,vv] (vv is the aftertouch value) are transmitted. When another device receives these messages, it will produce the effect specified by its aftertouch settings.

On the Prophecy, the settings of Edit mode Global section page GLB-10 [MIDI After Touch] allow Aftertouch (channel pressure) message transmission to be turned on/off, or Aftertouch messages converted to a specified Control Change message.

Some MIDI devices use a different type of aftertouch which allows an independent effect for each note (Polyphonic Key Pressure). The Prophecy does not implement this message, and all references to "aftertouch" in this manual refer to Channel Pressure (the type of aftertouch in which all notes are affected equally, regardless of the location on the keyboard).

5.6 Applying pitch bend*2

When the Pitch Bender function is assigned to a Wheel 1~3 or the Ribbon Controller of the Prophecy, you can operate that controller to apply a pitch bend effect. At the same time, the controller also transmits Pitch Bend messages [En,bb,mm]. (bb: lower byte of the value, mm: upper byte of the value, providing a value of 16384 steps, with 8192 [bb,mm=00,40] as the center value.)

If you want to control Pitch Bend from an external MIDI device, set Edit mode Global section page GLB-9 [MIDI Pitch Bend] Receive to "ENABLE".

5.7 Damper (Hold) pedal*2

If in Edit mode Common section page CMN-8 you assign a function of Sustain to the Foot SW jack, you can use a connected pedal switch to control the damper effect. At the same time, a Hold message [Bn,40,vv] (control change #64) will be transmitted. (vv: 127[7F] when ON, 00 when OFF).

If you want to control the damper effect from an external device using control change messages, set the Global section page GLB-11 [MIDI ControlChange] Control No. #64 Receive parameter to "ENBL". With this setting, messages with value "vv" of 63 [3F] or less will turn off the damper effect, and 64 [40] or higher will turn on the damper effect.

5.8 Adjusting the volume*2

If you have assigned Volume (control change #07) to a controller such as Wheel 1~3, the Ribbon Controller, or a connected pedal volume, operating that controller will control the volume. At the same time, Volume messages [Bn,07,vv] (control change #07) will be transmitted. (vv: value).

If you want to control the volume from an external device using control change messages, set the Global section page GLB-11 [MIDI ControlChange] control change #07 Receive parameter to "ENBL" or "INTP."

5.9 Applying vibrato (pitch modulation)*²

If you have assigned Pitch Modulation (control change #01) to a controller such as Wheel 1--3, the Ribbon Controller, or a connected pedal switch, operating that controller will control the vibrato effect. At the same time, Pitch Modulation Depth messages [Bn,01,vv] (control change #01) will be transmitted. (vv: value).

If you want to control pitch modulation from an external device using control change messages, set the Global section page GLB-11 [MIDI Control Change] control change #01 Receive parameter to "ENBL" or "INTP."

5.10 Control the stereo location (pan)*²

These settings are made in Edit mode Effect section page FX-4 [Pan & Output Level]. If you wish to control this using the MIDI Pan message [Bn,0A,vv] (control change #10) (vv: value), make settings in Edit mode Global section page GLB-11 [MIDI ControlChange] to set reception for Control Change #10 to "ENBL" or "INTP".

² *The Prophecy allows you to specify how the built-in controllers (Wheel 1/2/3, Ribbon Controller, etc.) and MIDI control messages (Control Change #00~#95, Pitch Bend, etc.) that are transmitted and received will correspond to the parameters of the tone generator (i.e., those parameters for which a modulation source can be selected). This means that the examples given in 5.5~5.10 above are only example of one particular setting, and are not fixed. (For the relation between controllers, messages and parameters, refer to the diagram in Global section GLB-9 [MIDI Pitch Bend].*

5.11 If the sound does not stop

If due to some problem a note becomes "stuck" and the sound does not stop, you can re-select a program to stop the sound.

If the Prophecy is receiving MIDI messages from a MIDI device that transmits Active Sensing messages [FE], and if for some reason no MIDI messages are received for a certain interval, the sound will automatically be halted.

5.12 Stopping the sound from an external MIDI device

When an All Note Off message [Bn,7B,00] (control change #123) is received, the Prophecy will turn off all its keys.

When an All Sound Off message [Bn,78,00] (control change #120) is received, the Prophecy will stop sounding. The difference between these two messages is that with All Note Off, the decay of the note will remain, while with All Sound Off, the note will stop immediately. However these messages are intended only for emergencies, and should not be used during normal playing.

5.13 To reset all controllers on a given channel

When an All Controller Reset message [Bn,79,00] (control change #121) is received, all controllers will be reset.

However this message is intended only for emergencies, and should not be used during normal playing.

5.14 About MIDI System Exclusive messages

System Exclusive messages are used to transmit data which is specific to a particular manufacturer or device.

The Prophecy's System Exclusive message format is [F0,42,3n,41,ff, ... ,F7] (n: Global MIDI Channel, ff: Function code). These messages are used for the functions explained in "5.15 Transmitting sound program data etc. (Data Dump)" and "5.16 Editing sound programs etc."

A few special System Exclusive messages are used for data which is not limited to a particular manufacturer or device. These are called Universal System Exclusive messages.

The Prophecy uses the following Universal System Exclusive messages.

* *When an Inquiry Message Request [F0,7F,nn,06,01,F7] (nn: MIDI channel) is received, the Prophecy will transmit an Inquiry message [F0,7E,nn,06,02, (9 bytes), F7] saying; "I am a Korg Prophecy, system version ..."*

5.15 Transmitting sound program data (Data Dump)

Programs, arpeggio patterns, and global data can be transmitted to an external device as MIDI exclusive data.

To transmit this data, use the Global mode page GLB-18 [MIDI DataDump]. There you can specify the type of data to be transmitted.

If the GLB-15 [Sys EX Filter] MIDI Exclusive Data Transmission setting is ON (Xmt: ON), selecting a program will cause MIDI Exclusive data for 1 program to be transmitted.

The Prophecy can also transmit these data dumps in response to a Dump Request. These types of data are transmitted and received on the Global MIDI channel.

5.16 Editing sound programs, etc.

By using MIDI System Exclusive Parameter Change messages, you can modify individual parameters from an external device.

If you wish to use this, set the Edit mode Global section page GLB-15 [SysEX Filter] Transmit to ON, and Receive to ENABLE.

* *If in page GLB-18 you specify either a bank of programs or an individual program as the data to be dumped, the received data will be written directly into backup memory, so there is no need to use the Write operation. However in the case of the data that is dumped when a program is selected, or parameter change data that is transmitted during editing, the changes that result will affect only the editing memory, and if you wish to save that program you will need to use the Write operation. (You do not need to use the Write operation for Global parameter data and Arpeggio Pattern data.) It is possible to perform the Write operation using the MIDI exclusive message Program Write. (Refer to the separate parameter guide, "MIDI Implementation".)*

5.17 The Performance Editor

In Performance mode, the Performance Ed allows you to edit parameters which have been assigned to the knobs. When you use the Performance Editor to modify a sound, the modified values will be transmitted as exclusive parameter changes (refer to Parameter Guide, MIDI Implementation). (This will occur only if the page GLB-15 parameter Transmit is ON.)

When these messages are received, the same performance edit will take place on the other Prophecy that received the data. After editing, you can Write the data to save in internal memory or RAM card. These messages are transmitted and received on the MIDI Global channel.

Changes in the sound that are made using the Performance Editor knobs are transmitted using the MIDI messages specified in Edit mode Global section page GLB-5.

PE1-4 on/off settings can be transmitted and received using MIDI NRPN messages. Use the following MIDI messages.

PE1	ON	[Bn 63 00 Bn 62 06 Bn 06 7F]
	OFF	[Bn 63 00 Bn 62 06 Bn 06 00]
PE2	ON	[Bn 63 00 Bn 62 07 Bn 06 7F]
	OFF	[Bn 63 00 Bn 62 07 Bn 06 00]
PE3	ON	[Bn 63 00 Bn 62 08 Bn 06 7F]
	OFF	[Bn 63 00 Bn 62 08 Bn 06 00]
PE4	ON	[Bn 63 00 Bn 62 09 Bn 06 7F]
	OFF	[Bn 63 00 Bn 62 09 Bn 06 00]

5.18 Synchronizing the arpeggiator

In Performance mode, you can synchronize the playback of the arpeggiator with an external device. Whether the Prophecy is the master (the controlling device) or the slave (the controlled device) is determined by the setting of Edit mode Global section page GLB-8 [MIDI] Clock Source.

- If the Clock Source is set to INTERNAL, the Prophecy will be the master, and the speed of the arpeggiator will be controlled by the dial on the front panel.
The arpeggiator playback will also be transmitted via MIDI, causing an external MIDI tone generator to play the same notes, or controlling the tempo of an external MIDI sequencer.
- If the Clock Source is set to EXTERNAL, the Prophecy will be the slave, and the arpeggiator speed will be determined by incoming MIDI Clock messages.

Arpeggiator operations can be transmitted and received using MIDI messages.

Bank Select (transmitted and received) [Bn 63 00 Bn 62 01 Bn 06 nn] nn:00~09 (internal), 0A~13 (card)

(The following four messages are received only.)

Arpeggiator on/off	[Bn 63 00 Bn 62 02 Bn 06 nn] nn:00~3F (off), 40~7F (on)
Arpeggiator octave	[Bn 63 00 Bn 62 03 Bn 06 nn] nn:00~03 (octave 1~4)
Arpeggiator latch	[Bn 63 00 Bn 62 04 Bn 06 nn] nn:00~3F (off), 40~7F (on)
Arpeggiator key sync	[Bn 63 00 Bn 62 05 Bn 06 nn] nn:00~3F (off), 40~7F (on)

5.19 Arpeggiator velocity and gate

The velocity and gate values of the arpeggiator can be controlled from a sequencer etc. using the MIDI messages specified by Edit mode Global section page GLB-6.

Prophecy MIDI Implementation Chart

Function...	Transmitted	Recognized	Remarks	
Basic channel Default Changed	1~16 1~16	1~16 1~16	Memorized	
Mode Default Messages Altered	× *****	4 3~4	Memorized	
Note Number: True voice	0~127 *****	0~127 0~127		
Velocity Note ON Note OFF	○ 9n, V=1~127 ×	○ 9n, V=1~127 ×	*B	
After Touch Key's Ch's	× ○	× ○	*A	
Pitch Bender	○	○	*C	
Control Change	0, 32 1 5 6 7, 11, 10 64 65 91, 92, 93, 94, 95 96, 97 98, 99 120, 121 122, 124 0~95	○ ○ × ○ ○ ○ ○ × ○ × × × ○	○ ○ ○ ○ ○ ○ ○ ○ ○ ○ ○ ○ ○	Bank Select (MSB, LSB) *P, *C Modulation *C Portamento Time *C Data Entry (MSB) *C Volume, Expression, Pan Pot *C Sustain *C Portamento Switch *C Effect Depth *C Data Increment/Decrement NRPN (LSB, MSB) *2 All Sound Off, Reset All Cntrls Local Control, Omni mode On/Off Wheel, Ribbon, Foot Pedal, Knob *C
Program Change: True#	○ 0~63 0~127	○ 0~63 0~127	*P	
System Exclusive	○	○	*2*E	
System Common: : Song Pos : Song Sel : Tune	× × ×	× × ×		
System Real Time : : Clock : Commands	× ×	× ×		
Aux Messages : Local ON/OFF : All Notes OFF : Active Sense : Reset	× × ○ ×	× ○ 123~125 ○ ×		

Notes *A, *B, *C, *E, *P: Valid only when Global parameter settings permit transmission and reception.
 *1: Only transmitted when Clock is Internal. Only received when Clock is External.
 *2: In addition to Korg exclusive messages, also compatible with Enquiry messages.

Mode 1 : OMNI ON, POLY Mode 2 : OMNI ON, MONO ○ : Yes
 Mode 3 : OMNI OFF, POLY Mode 4 : OMNI OFF, MONO × : No

No.	Program Name	Wheel1	Wheel2	Wheel3(+)	Wheel3(-)	Ribbon(X)	Ribbon(Z)	Foot Pedal	Foot SW	Ribbon(X) Variable Center Point
A00	Prophetic Steps!	P.Bend +/-	CC#1	CC#2	CC#3	CC#16	CC#17	CC#18	Sustain	Off
A01	Airworks	P.Bend +/-	CC#1	CC#2	CC#3	CC#16	CC#17	CC#18	Sustain	Off
A02	Dyna Slap Bass	P.Bend +/-	CC#1	CC#2	CC#3	CC#16	CC#17	CC#18	Sustain	Off
A03	Trumpet! → Whl	P.Bend +/-	CC#1	CC#1	CC#1	CC#16	CC#17	CC#18	Sustain	Off
A04	Studio Mog 1	P.Bend +/-	CC#1	CC#2	CC#3	CC#16	CC#17	CC#18	Sustain	Off
A05	The Whistler	P.Bend +/-	CC#1	CC#2	CC#3	CC#16	CC#17	CC#18	Sustain	Off
A06	The Big One	P.Bend +/-	CC#1	CC#2	CC#3	CC#16	CC#17	CC#18	Sustain	Off
A07	Waterphonics	P.Bend +/-	CC#1	CC#2	CC#3	CC#16	CC#17	CC#18	Sustain	Off
A08	AltoSax → Whl	P.Bend +/-	CC#1	CC#1	CC#1	AT	CC#17	CC#18	Sustain	Off
A09	Trombone → Whl	P.Bend +/-	CC#1	CC#1	CC#1	CC#16	CC#17	CC#18	Sustain	Off
A10	Piccolo Flute	P.Bend +/-	CC#1	CC#2	CC#3	CC#16	CC#17	CC#18	Sustain	Off
A11	FeedBeck	P.Bend +/-	CC#1	CC#2	CC#3	CC#16	CC#12	CC#18	Sustain	Off
A12	Countrytime → Whl	P.Bend +/-	CC#1	CC#2	CC#3	CC#16	CC#17	CC#18	Sustain	Off
A13	4 on the Floor	P.Bend +/-	CC#1	CC#2	CC#3	CC#16	CC#17	CC#18	Sustain	Off
A14	Slowaway	P.Bend +/-	CC#1	CC#2	CC#3	CC#16	CC#17	CC#18	Sustain	Off
A15	SpaceBeel Rbn → ?	P.Bend +/-	CC#1	CC#2	CC#3	CC#16	CC#17	CC#18	Sustain	Off
A16	Aboriginal	P.Bend +/-	CC#1	CC#2	CC#3	CC#16	CC#17	CC#18	Sustain	On
A17	Shakulute	P.Bend +/-	CC#1	CC#2	CC#3	CC#16	CC#17	CC#18	Sustain	Off
A18	Bagpipes in A	P.Bend +/-	CC#1	CC#2	CC#3	CC#16	CC#17	CC#18	Sustain	Off
A19	FrenchHorn	P.Bend +/-	CC#1	CC#1	CC#1	CC#16	CC#17	CC#18	Sustain	On
A20	Studio Mog 2	P.Bend +/-	CC#1	CC#2	CC#3	CC#16	CC#17	CC#18	Sustain	Off
A21	The Sine	P.Bend +/-	CC#1	CC#2	CC#3	CC#16	CC#17	CC#18	Sustain	Off
A22	All The Rave	P.Bend +/-	CC#1	CC#2	CC#3	CC#16	CC#17	CC#18	Sustain	Off
A23	Tubular Glass	P.Bend +/-	CC#1	CC#2	CC#3	CC#16	CC#17	CC#18	Sustain	Off
A24	SopranoSax	P.Bend +/-	CC#1	CC#1	CC#1	AT	CC#17	CC#18	Sustain	Off
A25	Phasing CLAV	P.Bend +/-	CC#1	CC#2	CC#3	CC#16	CC#17	CC#18	Sustain	Off
A26	ClavAnimal-Whl3	P.Bend +/-	CC#1	CC#2	CC#3	CC#16	CC#17	CC#18	Sustain	Off
A27	Jazz Guitar	P.Bend +/-	CC#1	CC#2	CC#3	CC#16	CC#17	CC#18	Sustain	Off
A28	==SkiJam III==	P.Bend +/-	CC#1	CC#2	CC#3	CC#16	CC#17	CC#18	Sustain	Off
A29	In The Drain	P.Bend +/-	CC#1	CC#2	CC#3	CC#16	CC#17	CC#18	Sustain	Off
A30	Symphony	P.Bend +/-	CC#1	CC#2	CC#3	CC#16	CC#17	CC#18	Sustain	Off
A31	Composite5thWhl1	P.Bend +/-	CC#1	CC#2	CC#3	CC#16	CC#17	CC#18	Sustain	Off
A32	DeepSpaceChatter	P.Bend +/-	CC#1	CC#2	CC#3	CC#16	CC#17	CC#18	Sustain	Off
A33	Recorder	P.Bend +/-	CC#1	CC#2	CC#3	CC#16	CC#17	CC#18	Sustain	Off
A34	Rock Bass	P.Bend +/-	CC#1	CC#2	CC#3	CC#16	CC#17	CC#18	Sustain	Off
A35	CupMuteTrumpet	P.Bend +/-	CC#1	CC#1	CC#1	CC#16	CC#17	CC#18	Sustain	Off
A36	Club Bass	P.Bend +/-	CC#1	CC#2	CC#3	CC#16	CC#17	CC#18	Sustain	Off
A37	Fifth'sLead → Rbn	P.Bend +/-	CC#1	CC#2	CC#3	CC#16	CC#17	CC#18	Sustain	Off
A38	Morph 303	P.Bend +/-	CC#1	CC#2	CC#3	CC#16	CC#17	CC#18	Sustain	Off
A39	Neo Bell	P.Bend +/-	CC#1	CC#2	CC#3	CC#16	CC#17	CC#18	Sustain	Off
A40	Oboe	P.Bend +/-	CC#1	CC#1	CC#1	CC#16	CC#17	CC#18	Sustain	Off
A41	Prophecy Organ	P.Bend +/-	CC#1	CC#2	CC#3	CC#16	CC#17	CC#18	Sustain	Off
A42	D'you know Bass	P.Bend +/-	CC#1	CC#2	CC#3	CC#16	CC#17	CC#18	Sustain	Off
A43	MuteGtr Rbn →	P.Bend +/-	CC#1	CC#2	CC#3	CC#16	CC#17	CC#18	Sustain	Off
A44	I Remember Donna	P.Bend +/-	CC#1	CC#2	CC#3	CC#16	CC#17	CC#18	Sustain	Off
A45	Maxisync	P.Bend +/-	CC#1	CC#2	CC#3	CC#16	CC#17	CC#18	Sustain	Off
A46	Fe-Voice	P.Bend +/-	CC#1	CC#2	CC#3	CC#16	CC#17	CC#18	Sustain	Off
A47	PhaseWindMotion	P.Bend +/-	CC#1	CC#2	CC#3	CC#16	CC#17	CC#18	Sustain	Off
A48	Xenex	P.Bend +/-	CC#1	CC#2	CC#3	CC#16	CC#17	CC#18	Sustain	Off
A49	Blown Glass	P.Bend +/-	CC#1	CC#2	CC#3	CC#16	CC#17	CC#18	Sustain	Off
A50	Phretless	P.Bend +/-	CC#1	CC#2	CC#3	CC#16	CC#17	CC#18	Sustain	Off
A51	2SynGuitars → Whl	P.Bend +/-	CC#1	CC#2	CC#3	CC#16	CC#17	CC#18	Sustain	Off
A52	Dr.Mougue's Bass	P.Bend +/-	CC#1	CC#2	CC#3	CC#16	CC#17	CC#18	Sustain	Off
A53	Mini KORG 700s	P.Bend +/-	CC#1	CC#2	CC#3	CC#16	CC#17	CC#18	Sustain	Off
A54	New Emersonian	P.Bend +/-	CC#1	CC#2	CC#3	CC#16	CC#17	CC#18	Sustain	Off
A55	QuasimotoBells	P.Bend +/-	CC#1	CC#2	CC#3	CC#16	CC#17	CC#18	Sustain	Off
A56	TenorSax1 → Whl	P.Bend +/-	CC#1	CC#1	CC#1	AT	CC#17	CC#18	Sustain	Off
A57	===AutoClav===	P.Bend +/-	CC#1	CC#2	CC#3	CC#16	CC#17	CC#18	Sustain	Off
A58	Logg Bass	P.Bend +/-	CC#1	CC#2	CC#3	CC#16	CC#17	CC#18	Sustain	Off
A59	MultiGtr → Whl3	P.Bend +/-	CC#1	CC#2	CC#3	CC#16	CC#17	CC#18	Sustain	Off
A60	Cyclotron	P.Bend +/-	CC#1	CC#2	CC#3	CC#16	CC#17	CC#18	Sustain	Off
A61	lo-nic 8 lead	P.Bend +/-	CC#1	CC#2	CC#3	CC#16	CC#17	CC#18	Sustain	Off
A62	AhYahYah	P.Bend +/-	CC#1	CC#2	CC#3	CC#16	CC#17	CC#18	Sustain	Off
A63	Not Unlucky!	P.Bend +/-	CC#1	CC#2	CC#3	CC#16	CC#17	CC#18	Sustain	Off

No.	Program Name	Wheel1	Wheel2	Wheel3(+)	Wheel3(-)	Ribbon(X)	Ribbon(Z)	Foot Pedal	Foot SW	Ribbon(X) Variable Center Point
B00	Space Adventure	P.Bend +/-	CC#1	CC#2	CC#3	CC#16	CC#17	CC#18	Sustain	Off
B01	Reedfife	P.Bend +/-	CC#1	CC#2	CC#3	CC#16	CC#17	CC#18	Sustain	Off
B02	Finger Bass	P.Bend +/-	CC#1	CC#2	CC#3	CC#16	CC#17	CC#18	Sustain	Off
B03	Accoustic Guitar	P.Bend +/-	CC#1	CC#2	CC#3	CC#16	CC#17	CC#18	Sustain	Off
B04	Control Bass	P.Bend +/-	CC#1	CC#2	CC#3	CC#16	CC#17	CC#18	Sustain	Off
B05	Clicky	P.Bend +/-	CC#1	CC#2	CC#3	CC#16	CC#17	CC#18	Sustain	Off
B06	Anafuzz	P.Bend +/-	CC#1	CC#2	CC#3	CC#16	CC#17	CC#18	Sustain	Off
B07	GlassToy! Rbn →	P.Bend +/-	CC#1	CC#2	CC#3	CC#16	CC#17	CC#18	Sustain	Off
B08	BaritoneSax	P.Bend +/-	CC#1	CC#1	CC#1	CC#16	CC#17	CC#18	Sustain	Off
B09	Organ Bass	P.Bend +/-	CC#1	CC#2	CC#3	CC#16	CC#17	CC#18	Sustain	Off
B10	R.Pageator → Rbn →	P.Bend +/-	CC#1	CC#2	CC#3	CC#16	CC#17	CC#18	Sustain	Off
B11	Dist 5th Guitar	P.Bend +/-	CC#1	CC#2	CC#3	CC#16	CC#17	CC#18	Sustain	Off
B12	Dune Rize	P.Bend +/-	CC#1	CC#2	CC#3	CC#16	CC#17	CC#18	Sustain	Off
B13	Ana-Log-Pod	P.Bend +/-	CC#1	CC#2	CC#3	CC#16	CC#17	CC#18	Sustain	Off
B14	Grungy	P.Bend +/-	CC#1	CC#2	CC#3	CC#16	CC#17	CC#18	Sustain	Off
B15	Comb-Comp	P.Bend +/-	CC#1	CC#2	CC#3	CC#16	CC#17	CC#18	Sustain	Off
B16	RDM4 Fluctuation	P.Bend +/-	CC#1	CC#2	CC#3	CC#16	CC#17	CC#18	Sustain	Off
B17	Air Flute	P.Bend +/-	CC#1	CC#2	CC#3	CC#16	CC#17	CC#18	Sustain	Off
B18	Accoustic Bass	P.Bend +/-	CC#1	CC#2	CC#3	CC#16	CC#17	CC#18	Sustain	Off
B19	Korgiami	P.Bend +/-	CC#1	CC#2	CC#3	CC#16	CC#17	CC#18	Sustain	Off
B20	SQ Bass	P.Bend +/-	CC#1	CC#2	CC#3	CC#16	CC#17	CC#18	Sustain	Off
B21	Clean Fuzz!	P.Bend +/-	CC#1	CC#2	CC#3	CC#16	CC#17	CC#18	Sustain	Off
B22	Softsyn	P.Bend +/-	CC#1	CC#2	CC#3	CC#16	CC#17	CC#18	Sustain	Off
B23	Dual Waterphones	P.Bend +/-	CC#1	CC#2	CC#3	CC#16	CC#17	CC#18	Sustain	Off
B24	TenorSax2	P.Bend +/-	CC#1	CC#1	CC#1	AT	CC#17	CC#18	Sustain	Off
B25	Neo Clav	P.Bend +/-	CC#1	CC#2	CC#3	CC#16	CC#17	CC#18	Sustain	Off
B26	Sequence Delays	P.Bend +/-	CC#1	CC#2	CC#3	CC#16	CC#17	CC#18	Sustain	Off
B27	HoldMe4FeedBack!	P.Bend +/-	CC#1	CC#2	CC#3	CC#16	CC#17	CC#18	Sustain	Off
B28	CircularReason 12	P.Bend +/-	CC#1	CC#2	CC#3	CC#16	CC#17	CC#18	Sustain	Off
B29	Like Mini	P.Bend +/-	CC#1	CC#2	CC#3	CC#16	CC#17	CC#18	Sustain	Off
B30	Heavy Ring Bong	P.Bend +/-	CC#1	CC#2	CC#3	CC#16	CC#17	CC#18	Sustain	Off
B31	Rib Bone Lead	P.Bend +/-	CC#1	CC#2	CC#3	CC#16	CC#17	CC#18	Sustain	Off
B32	L'ef Oh,WaveSeq!	P.Bend +/-	CC#1	CC#2	CC#3	CC#16	CC#17	CC#18	Sustain	Off
B33	OUTBACK-HoldLowC	P.Bend +/-	CC#1	CC#2	CC#3	CC#16	CC#17	CC#18	Sustain	Off
B34	Pick Bass → Rbn	P.Bend +/-	CC#1	CC#2	CC#3	CC#16	CC#17	CC#18	Sustain	Off
B35	Groove Kit → Rbn	P.Bend +/-	CC#1	CC#2	CC#3	CC#16	CC#17	CC#18	Sustain	Off
B36	Moralee Bass :-L	P.Bend +/-	CC#1	CC#2	CC#3	CC#16	CC#17	CC#18	Sustain	Off
B37	SunriseSyncLead	P.Bend +/-	CC#1	CC#2	CC#3	CC#16	CC#17	CC#18	Sustain	Off
B38	Mini Like	P.Bend +/-	CC#1	CC#2	CC#3	CC#16	CC#17	CC#18	Sustain	Off
B39	Southern Accents	P.Bend +/-	CC#1	CC#2	CC#3	CC#16	CC#17	CC#18	Sustain	Off
B40	HighStevie	P.Bend +/-	CC#1	CC#2	CC#3	CC#16	CC#17	CC#18	Sustain	Off
B41	Velofilter Rbn →	P.Bend +/-	CC#1	CC#2	CC#3	CC#16	CC#17	CC#18	Sustain	Off
B42	Bass 4 Da Funk	P.Bend +/-	CC#1	CC#2	CC#3	P.Bend +/-	CC#17	CC#18	Sustain	On
B43	Single Picking	P.Bend +/-	CC#1	CC#2	CC#3	CC#16	CC#17	CC#18	Sustain	Off
B44	Auto/Random → Whl	P.Bend +/-	CC#1	CC#2	CC#3	CC#16	CC#17	CC#18	Sustain	Off
B45	Trance Arpeggi!	P.Bend +/-	CC#1	CC#2	CC#3	CC#16	CC#17	CC#18	Sustain	Off
B46	Re-Bong Strings	P.Bend +/-	CC#1	CC#2	CC#3	CC#16	CC#17	CC#18	Sustain	Off
B47	Comb-byte	P.Bend +/-	CC#1	CC#2	CC#3	CC#16	CC#17	CC#18	Sustain	Off
B48	PickUpMotionBass	P.Bend +/-	CC#1	CC#2	CC#3	CC#16	CC#17	CC#18	Sustain	Off
B49	EerieSyn → RbnWhl	P.Bend +/-	CC#1	CC#2	CC#2	CC#16	CC#17	CC#18	Sustain	Off
B50	Buzz Bass	P.Bend +/-	CC#1	CC#2	CC#3	CC#16	CC#17	CC#18	Sustain	Off
B51	Tablann	P.Bend +/-	CC#1	CC#2	CC#3	CC#16	CC#17	CC#18	Sustain	Off
B52	303Growler Rbn →	P.Bend +/-	CC#1	CC#2	CC#3	CC#16	CC#17	CC#18	Sustain	Off
B53	Saurus → Whl	P.Bend +/-	CC#1	CC#2	CC#3	CC#16	CC#17	CC#18	Sustain	Off
B54	CombMody → Whl3	P.Bend +/-	CC#1	CC#2	CC#3	CC#16	CC#17	CC#18	Sustain	Off
B55	Cyberbell	P.Bend +/-	CC#1	CC#2	CC#3	CC#16	CC#17	CC#18	Sustain	Off
B56	Da Bottle	P.Bend +/-	CC#1	CC#2	CC#3	CC#16	CC#17	CC#18	Sustain	Off
B57	Clock Mel	P.Bend +/-	CC#1	CC#2	CC#3	CC#16	CC#17	CC#18	Sustain	Off
B58	The Bottom End	P.Bend +/-	CC#1	CC#2	CC#3	CC#16	CC#17	CC#18	Sustain	Off
B59	JazzGtr Rbn →	P.Bend +/-	CC#1	CC#2	CC#3	CC#16	CC#17	CC#18	Sustain	Off
B60	Soft Slappers	P.Bend +/-	CC#1	CC#2	CC#3	CC#16	CC#17	CC#18	Sustain	Off
B61	House Kit Rbn	P.Bend +/-	CC#1	CC#2	CC#3	CC#16	CC#17	CC#18	Sustain	Off
B62	Dia-log-ue 1 & 3	P.Bend +/-	CC#1	CC#2	CC#3	CC#16	CC#17	CC#18	Sustain	Off
B63	Morphing Noises	P.Bend +/-	CC#1	CC#2	CC#3	CC#16	CC#17	CC#18	Sustain	Off

Specifications

	Prophecy
Sound Generation Method	MOSS (Multi-Oscillator Synthesis System)
Sound Source	2 oscillators (max.) + Sub Oscillator + Noise Generator, Monophonic
Keyboard	37 notes, with velocity and aftertouch sensitivity
Effects	7 effects, including Distortion, Wah, dual Parametric EQ, and a choice of Chorus/Flanger + Delay or Reverb.
Programs	128 programs
Arpeggiator Section	5 preset patterns, 5 user patterns
Controllers	3 x Modulation Wheel, Ribbon Controller
Control Inputs	Assignable Foot Switch, Assignable Foot Pedal
Outputs	L/Mono, R, Headphones
MIDI	IN, OUT, THRU
Card Slot	Program Data, Arpeggio Patterns
Display	40 x 2 character LCD
Power Supply	AC, Local Voltage
Power Consumption	10W
Dimensions	740 (W) x 286 (D) x 100 (H) mm
Weight	5.7kg
Accessories	AC cord

Options

Expression/Volume Pedal

XVP-10, VP-10, KVP-002, EXP-2

Pedal Switch

PS-1, PS-2

Damper Pedal

DS-1, DS-2

External Controller

EC5

Memory Card RAM

SRC-512

Monitors

RM-15B, PM-5

Hard Case

NOTICE

KORG products are manufactured under strict specifications and voltages required by each country. These products are warranted by the KORG distributor only in each country. Any KORG product not sold with a warranty card or carrying a serial number disqualifies the product sold from the manufacturer's/distributor's warranty and liability. This requirement is for your own protection and safety.

KORG KORG INC.

15 - 12, Shimotakaido 1 - chome, Suginami-ku, Tokyo, Japan.